

Cylindrical Roller Bearings

Cylindrical roller bearings are manufactured by NTN-Bower in several series that differ in proportion, width, and load rating. Bore size for each series increases in multiples of five or more millimeters and for each bore size a selection of different narrow and wide series is available to meet the needs of most applications. External dimensions and tolerances conform to RBEC #1 metric bearing standards as defined in the American Bearing Manufacturers Association (ABMA) and American National Standards Institute (ANSI).

NTN-Bower standard product lines include two basic series: the “M” series for light and medium radial loads and the “W” series for heavy to extra heavy radial loads. Only complete bearing assemblies interchange between the Max-Pak and the “M” series bearings; separable rings and roller assemblies do not.

The “W” (Max-Pak) series provides an average radial load rating increase of 20 percent and a life increase of 80 percent. These increases are possible by reducing the wall thickness of the bearing rings. This reduction provides additional space for larger rollers resulting in higher calculated ratings.

While cylindrical roller bearings are designed primarily for high radial loads, certain types are capable of handling light and intermittent thrust loads, which also permits them to be used for axial shaft location.

The cylindrical roller bearing is a nonadjustable design. The correct radial internal clearance is built in at time of manufacture; when properly installed, the bearing has the correct running clearance. By using an “A” style outer ring, a press fit for the outer ring is obtained when installed in a housing previously designed to produce a tap fit.

NTN-Bower also manufactures a limited number of specialty bearings that include the “MOJ” and “MOX” style, custom “R” series, mast and chain guide bearings. A part number listing, dimensional data and load ratings can be found in the special bearing section of this catalog on page 72.

Radial Section Comparison

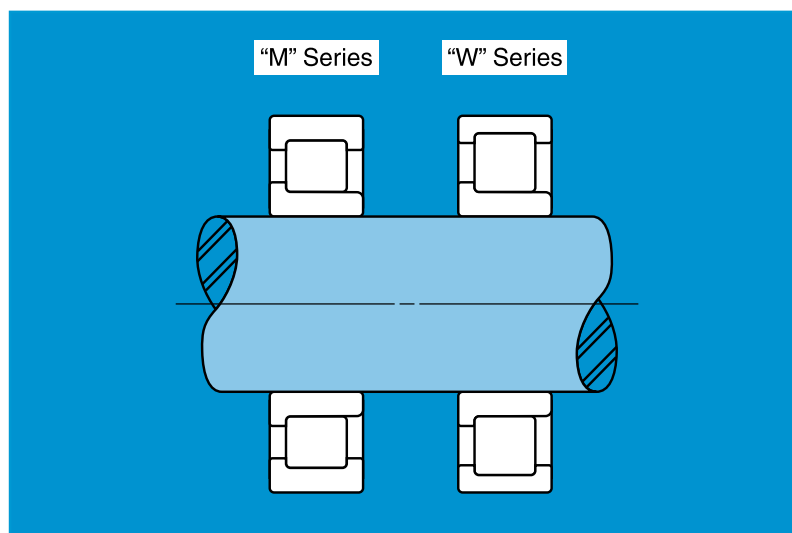

Bearing Design

“M” SERIES BEARINGS

The “M” series designated by the prefix letter “M” satisfies most commercial applications and is available in a broad range of sizes and types up to 20” (508 mm) outside diameter. This series is available with several types of cages including composite steel, “X” bar, stamped steel, and *Fibron. This series is also available with a full complement of rollers (i.e., no cage).



“W” (MAX-PAK) SERIES BEARINGS

The Max-Pak series with the prefix letter “W” interchanges with the “M” series and is designed for applications with very heavy radial loads. This series can be produced in most of the same types and sizes as the “M” series and is available with an “X” bar steel or stamped steel cage.

“A” style (oversize outer ring for heavy press fit in a standard size housing bore) is the standard Outside Diameter for the Max-Pak series.

For individual part number availability, contact NTN Sales.



Series Interchange

M Series	Max-Pak
M1900	W61900
M1000	W61000
M1200	W61200
M5200	W65200
M1300	W61300
M7300	W67300

***“Fibron” is the NTN—Bower trade name for nonmetallic cages**

Bearing Design

CAGES

“M” series bearings are supplied with one of four basic cage styles; composite steel, one piece steel, “X” bar, and Fibron. Bearing load ratings for various cage styles are included in the “Dimensions and Load Ratings” section of this catalog. Load ratings for bearings using Fibron cages are the same as the column for inner ring assemblies with one-piece steel cages.

The composite steel cage provides more rollers for a given bearing size than is possible with other designs to offer greater radial load carrying capacity. Guidance for this cage is located on the ground ribs of the ring containing the rollers.

The one piece steel cage provides a maximum number of equally spaced rollers for a given bearing size. This cage is simple, light weight and exceptionally strong. Its open construction permits free flow of lubricant through the bearing, which is especially important for relatively high temperature and high speed applications.

The “X” bar steel cage offers line contact at four locations to each roller resulting in superior roller guidance. This can allow for higher rotational speeds and greater running accuracy.

MATERIAL

Both rings and rollers of NTN-Bower cylindrical roller bearings are made from case hardened alloy steel of “Bearing Quality” to provide maximum fatigue life and reliability. Precise control of heat treatment, dimensions, and surface finish of the components further contribute to reliable bearing performance.

CROWNED ROLLERS

NTN-Bower’s pioneering efforts in developing crowned rollers for cylindrical roller bearings have resulted in greater load carrying capacity and substantially longer bearing life. Crowned rollers, under load, distribute stress equally along their full length of contact with the raceways, thereby eliminating stress concentration at the roller ends. This design concept also compensates for minor misalignment between shaft and housing bores and deflections under load by reducing stress concentrations.

Crowned rollers are manufactured in two basic profiles. A full crown roller is used in small size bearings or in applications where high misalignment is expected and a modified “dubbed” crown in the large size bearings.



X BAR STEEL CAGE



FIBRON CAGE



ONE PIECE STEEL CAGE



COMPOSITE STEEL CAGE

(This page left intentionally blank.)

Numbering System

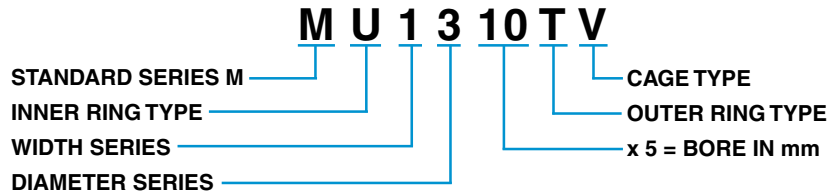

PREFIX LETTERS

1	2	3	4	
C	A			Plain Inner Ring
		B		Special Features
			C	Mast and Chain Guide Bearings
			D	Special Features
			D	Inner Ring Bore 5mm Undersize (Max-Pak Series Only)
			E	Inner Ring Bore 10mm Undersize (Max-Pak Series Only)
			E	Inner Ring Bore 15mm Undersize (Max-Pak Series Only)
M			G	Inner Ring Bore 20mm Undersize (Max-Pak Series Only)
		N	N	Standard Metric Series
			N	Inner Ring Plate
		R		Custom Series
		R		One Ribbed Inner Ring
		S		Short, One Ribbed Inner Ring
		T	T	5mm or 10mm Undersize Bore
W		U		Two Ribbed Inner Ring
		X		Max-Pak 60000 Series Unground Rib O.D.

SUFFIX LETTERS

1	2	3	4	5	
	A	A			Oversized O.D. for Heavy Press Fit in Standard Housing Bore
	B	B	B		Special Features
C	C	C			Plain Outer Ring
D	D				One Ribbed Outer Ring
E	E				Two Ribbed Outer Ring
F	F	F	F	F	Unground Rib I.D.
G	G	G			Fibron Cage
	H	H			Snap Ring Groove in Outer Ring O.D.
	H	H			Blind Dowel Hole in Outer Ring O.D.
J	J	J	J	J	Brass or Bronze Cage
L	L	L	L	L	Composite Steel Cage
	M	M	M	M	Full Complement Bearing (No Cage)
	N	N			Outer Ring Plate
			R	R	Snap Ring Assembled in Outer Ring O.D.
S					Short, One Ribbed Outer Ring
T	T	T			Two Retaining Rings in Outer Ring I.D.
U	U				One Rib, One Retaining Ring in Outer Ring I.D.
V	V	V	V	V	One Piece Steel Cage
X					Unground Rib I.D.
X	X	X	X	X	"X" Bar Composite Steel Cage

INNER RING TYPES

Prefix Letters

A R N S U

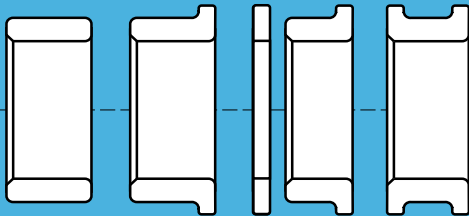

OUTER RING TYPES

Suffix Letters

C D E S N T U

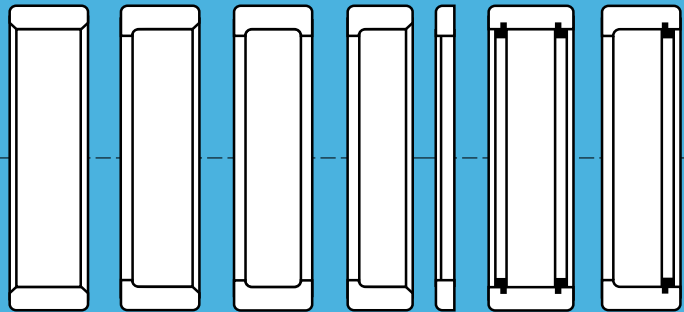

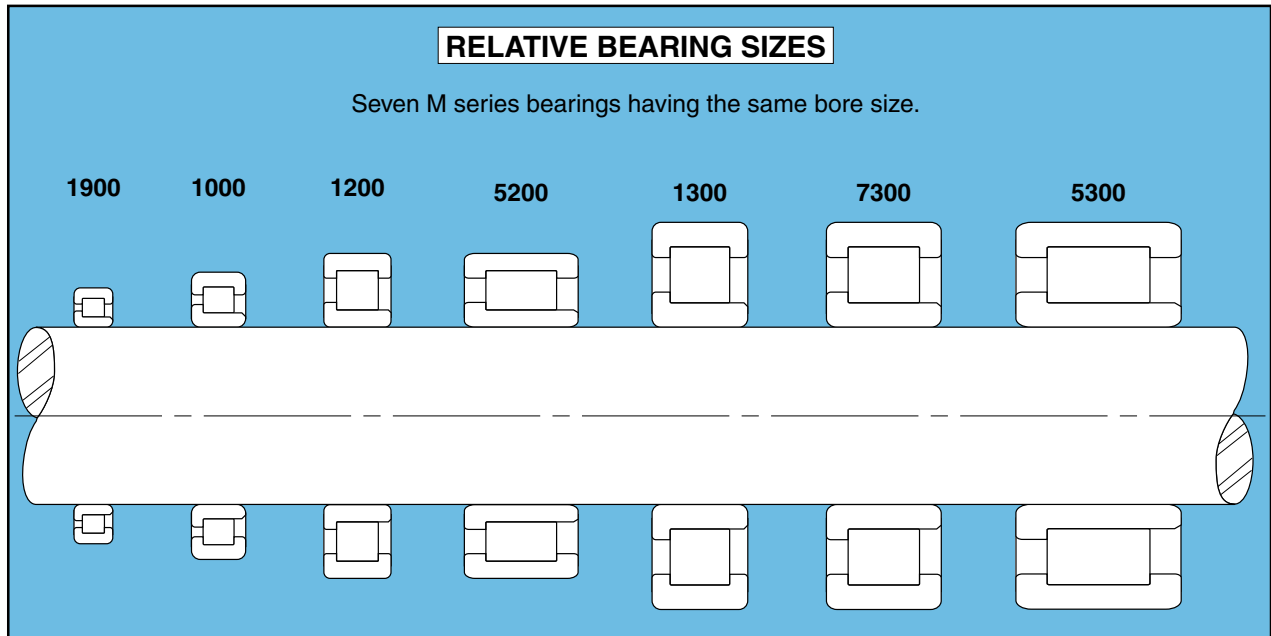
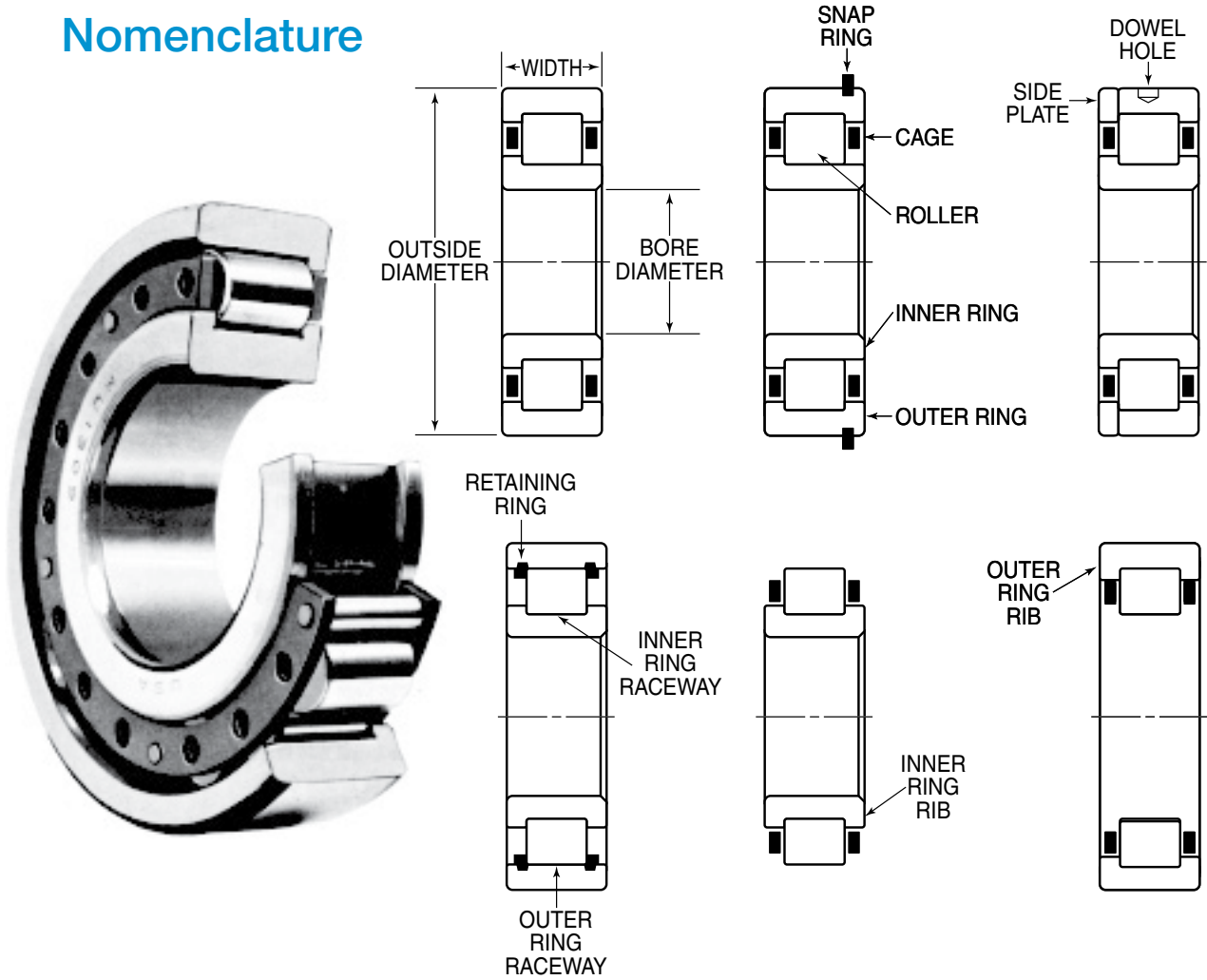

Nomenclature



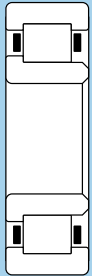
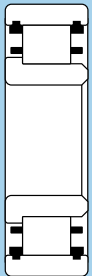

Bearing Types

SEPARABLE INNER RINGS

 <p>MA---EL</p>	<p><u>Design Features</u></p> <ul style="list-style-type: none"> • Two ribbed outer ring. • Straight, separable inner ring. • Rollers retained with outer ring. • Composite steel cage. <p><u>Application</u></p> <ul style="list-style-type: none"> • Permits axial float of shaft. • Accommodates contraction or expansion at one end of a shaft. Bearing at opposite end locates shaft.
 <p>MA---TV</p>	<p><u>Design Features</u></p> <ul style="list-style-type: none"> • Two split retaining rings in outer ring. • Straight, separable inner ring. • Rollers retained with outer ring. • One-piece steel cage. <p><u>Application</u></p> <ul style="list-style-type: none"> • Permits axial float of shaft. • Low cost bearing type. • Accommodates contraction or expansion at one end of a shaft. Bearing at opposite end locates shaft.
 <p>MR---EL</p>	<p><u>Design Features</u></p> <ul style="list-style-type: none"> • Two ribbed outer ring. • One ribbed, separable inner ring. • Rollers retained with outer ring. • Composite steel cage. <p><u>Application</u></p> <ul style="list-style-type: none"> • Takes moderate thrust loads or locates shaft in one direction only. • When used in pairs on a common shaft, thrust loads can be taken or shaft located in either direction.
 <p>MR---TV</p>	<p><u>Design Features</u></p> <ul style="list-style-type: none"> • Two split retaining rings in outer ring. • One ribbed, separable inner ring. • Rollers retained with outer ring. • One-piece steel cage. <p><u>Application</u></p> <ul style="list-style-type: none"> • Outer ring is located, axially, in one direction by inner ring rib. Location in opposite direction must be provided for. • Rib on inner ring can be used to facilitate its removal from shaft. • Will not accommodate thrust loads or locate shaft.

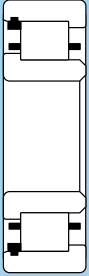
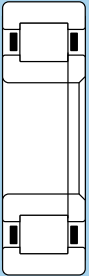
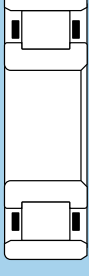

Bearing Types

SEPARABLE INNER RINGS (continued)

 <p>MR---UV</p>	<p><u>Design Features</u></p> <ul style="list-style-type: none"> • One split retaining ring and one rib in outer race. • One ribbed, separable inner ring. • Rollers retained with outer ring. • One-piece steel cage. <p><u>Application</u></p> <ul style="list-style-type: none"> • Takes moderate thrust loads or locates rotating member in one direction. • When used in pairs on a common shaft, thrust loads can be taken or shaft located in either direction.
 <p>MSN---EL</p>	<p><u>Design Features</u></p> <ul style="list-style-type: none"> • Two ribbed outer ring. • Removable, short, one ribbed inner ring and loose side plate. • Rollers retained with outer ring. • Composite steel cage <p><u>Application</u></p> <ul style="list-style-type: none"> • Takes moderate thrust loads or locates rotating member, axially, in both directions. • Bearing can be installed separately or as a unit.
<h3>SEPARABLE OUTER RINGS</h3>	
 <p>MU---CL</p>	<p><u>Design Features</u></p> <ul style="list-style-type: none"> • Straight, separable outer ring. • Two ribbed inner ring. • Rollers retained with inner ring. • Composite steel cage <p><u>Application</u></p> <ul style="list-style-type: none"> • Permits axial float of shaft like MA—EL but rollers are retained with inner ring; desirable for some applications. • Straight outer ring design is ideal for oil flow and purging contaminants.
 <p>MU---CV</p>	<p>Same design features and application as described above for MU—CL, except uses one-piece steel cage.</p>

Bearing Types

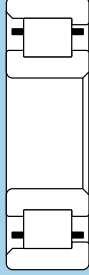
SEPARABLE OUTER RINGS (continued)

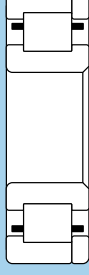
 <p>MU---DL</p>	<p><u>Design Features</u></p> <ul style="list-style-type: none"> • One ribbed, separable outer ring. • Two ribbed inner ring. • Rollers retained with inner ring. • Composite steel cage. <p><u>Application</u></p> <ul style="list-style-type: none"> • Takes moderate thrust loads or locates shaft in one direction only. • When used in pairs on common shaft, thrust loads can be taken or shaft located in either direction.
 <p>MU---DV</p>	<p>Same design features and applications as MU—DL above, except uses one-piece steel cage.</p>
 <p>MU---SNL</p>	<p><u>Design Features</u></p> <ul style="list-style-type: none"> • Removable, short, one ribbed outer ring and loose side plate. • Two ribbed inner ring. • Rollers retained with inner ring. • Composite steel cage <p><u>Application</u></p> <ul style="list-style-type: none"> • Takes moderate thrust loads or locates rotating members axially in both directions. • Bearing can be installed separately or as a unit.
 <p>MU---SNV</p>	<p>Same design features and application as MU—SNL above except uses one-piece steel cage.</p>

Bearing Types

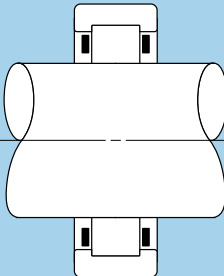
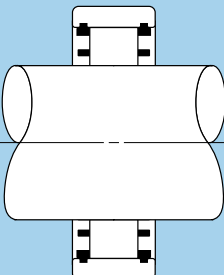
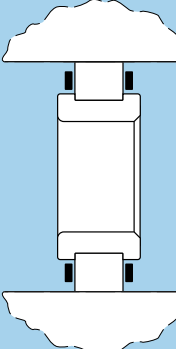
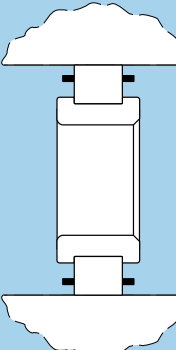

INNER OR OUTER RING OMITTED

 <p>M---EL</p>	<p><u>Design Features</u></p> <ul style="list-style-type: none"> • Two ribbed outer ring. • Inner ring omitted. • Composite steel cage. 	<p><u>Application</u></p> <ul style="list-style-type: none"> • Where mounting space is limited, rollers run directly on a hardened and ground shaft.* • Shaft diameter can be increased to replace omitted outer ring for added stiffness. • Savings are possible by using a smaller bearing and eliminating inner ring.
 <p>M---TV</p>	<p><u>Design Features</u></p> <ul style="list-style-type: none"> • Two split retaining rings in outer ring. • Inner ring omitted. • One-piece steel cage. 	<p><u>Application</u></p> <ul style="list-style-type: none"> • Use is similar to M—EL above.
 <p>MU---L</p>	<p><u>Design Features</u></p> <ul style="list-style-type: none"> • Outer ring is omitted. • Two ribbed inner ring. • Composite steel cage. 	<p><u>Application</u></p> <ul style="list-style-type: none"> • Where space is limited, housing bore can be reduced—permitting rollers to run directly on hardened and ground housing bore.* • Shaft diameter can be increased for added stiffness by eliminating outer ring and using next larger size bearing bore. Housing bore is modified to suit diameter over the rollers. • Savings are possible through eliminating outer ring.
 <p>MU---V</p>	<p>Same design features and application as MU—L above except bearing uses one-piece steel cage.</p>	

*Note: Shaft or housing bore surfaces functioning as bearing raceways must have a hardness of Rockwell C58 to C64 and a maximum surface finish of 18 AA. Deviation from this surface finish or hardness will require a reduction in the catalog rating of the bearing. Consult NTN Engineering for a recommendation.

Bearing Types

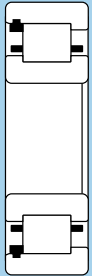
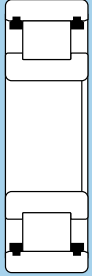
NON-SEPARABLE BEARINGS

 <p>MU----TV</p>	<p><u>Design Features</u></p> <ul style="list-style-type: none"> • Two split retaining rings in outer ring. • Two ribbed inner ring. • One-piece steel cage. <p><u>Application</u></p> <ul style="list-style-type: none"> • Used where bearing must be assembled as a unit and where design has no provision to retain outer ring axially. • Will not accommodate thrust loads or locate shaft.
 <p>MU----UV</p>	<p>Same design features and applications as MU—TV above, except outer ring contains one split retaining ring and one solid rib which will take moderate thrust loads or locate shaft in one direction.</p>
 <p>MU----TM</p>	<p><u>Design Features</u></p> <ul style="list-style-type: none"> • Two split retaining rings in outer ring. • Two ribbed inner ring. • No cage (full complement of rollers). <p><u>Application</u></p> <ul style="list-style-type: none"> • Use is similar to MU—TV above. • Cage is omitted and rollers are added for increased radial load capacity. Permissible bearing speed, however, is less than the caged type bearing.
 <p>MU----UM</p>	<p>Same design features and application as MU—TM above except outer ring contains one split retaining ring and one solid rib that will take a moderate thrust load or locate shaft in one direction.</p>

Interchange Charts for Basic Series*

SEPARABLE INNER RING TYPE BEARINGS

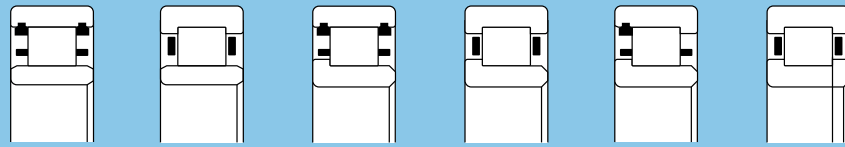

BOWER	MA---TV	MA---EL	MR---TV	MR---EL	MR---UV	MSN---EL
AFBMA	--RM--	--RU--	--RR--	--RJ--	--RS--	--RT--
FAG		NU--		NJ--		NUP--
HYATT	A---TS	A---WB	R---TS	R---WB	R---YS	JRN---WB
LINK BELT	MA---TV	MA---EX	MR---TV	MR---EX	MR---UV	MSN---EX
ROLL WAY	E---B	E---U	L---B	L---U	L---J	LP---U
SKF	HNU---A		HNJ---A			
NTN		NU--		NJ--		NUP--

SEPARABLE OUTER RING TYPE BEARINGS

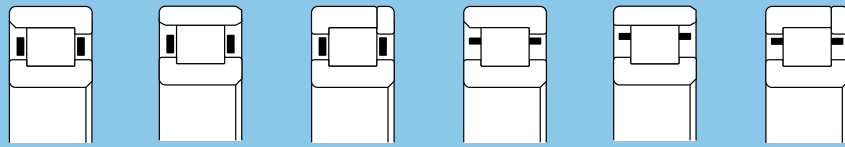

BOWER	MU---DL	MU---CL	MU---SNL	MU---DV	MU---CV	MU---SNV
AFBMA	--RF--	--RN--	--RP--	--RF--	--RN--	--RP--
FAG	NF---	N---		NF--	N---	
HYATT	BU---L	BU---Z	BU---LNJ	BU---L	BU---Z	BU---LNJ
LINK BELT	MU---DX	MU---CX	MU---SNX	MU---DX	MU---CX	MU---SNX
ROLL WAY	U---L	U---E	U---LP	U---L	U---E	U---LP
SKF						
NTN	NF--	N--	NP--	NF--	N--	NP--

NON-SEPARABLE TYPE BEARINGS

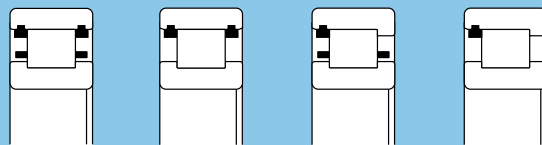

BOWER	MU---TV	MU---TM	MU---UV	MU---UM
AFBMA	--RK--	--RK--V	--RY--	--RY--V
FAG				
HYATT	U---TS	U---TM	U---YS	U---YM
LINK BELT	MU---TV	MU---TM	MU---UV	MU---UM
ROLL WAY	U---B	UM---B	U---J	UM---J
SKF	HNC---A	HNC---AV		
NTN		NV--		

* Charted bearings interchange for boundary dimensions (I.D., O.D., width) and bearing types. They may not interchange due to differences in load ratings or cage styles.

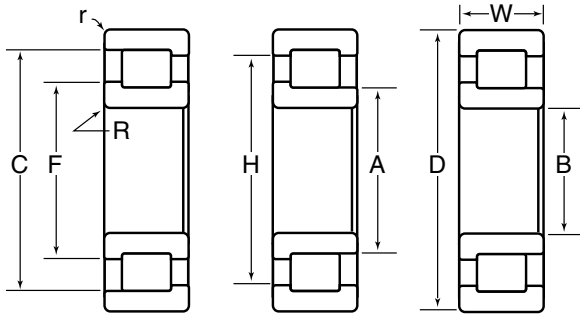

DIMENSIONS

The basic boundary dimensions (bore, outside diameter, width) in the following tables conform to the standards established by ABMA/ANSI.

A description of dimensions represented by various letters is given below:

- B** Maximum bearing bore diameter. The minus tolerance is given on page 79 and the range in "Fitting Practice" section
- D** Maximum bearing O.D. The minus tolerance is given on page 79 and the range in "Fitting Practice" section
- W** Maximum bearing width. The minus tolerance is given on page 79.
- A** Maximum O.D. of the inner ring raceway
- C** Minimum I.D. of the outer ring raceway
- F** Maximum rib O.D. of the inner ring
- H** Minimum rib I.D. of the outer ring
- R** Maximum fillet on the shaft that the bearing corner will clear
- r** Maximum fillet in the housing that the bearing corner will clear

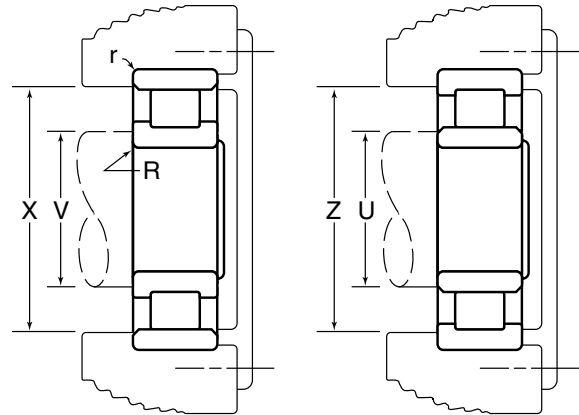

- X** Recommended maximum housing shoulder diameter for plain outer rings
- V** Recommended minimum shaft shoulder diameter for ribbed inner rings
- Z** Recommended maximum housing shoulder diameter for ribbed outer rings
- U** Recommended minimum shaft shoulder diameter for plain inner rings

Dimensions shown in tables are given in both inch and metric units and are based on:

- 1 inch = 25.4 mm exactly
- 1 micrometer = 1µm = 10⁻⁶ m
- 1 micrometer = .001 mm

LOAD RATINGS

The radial load ratings in this catalog are based on 500 hrs L₁₀ life at 33 1/3 rpm or 1 million cycles for either inner or outer ring rotation. To convert this rating to 3000 hrs L₁₀ life at 500 rpm or 90 million cycles basis, divide by 3.857.

The load ratings, dynamic and static, are shown in both pounds and newtons, i.e.,

- 1 pound = 4.448 newtons

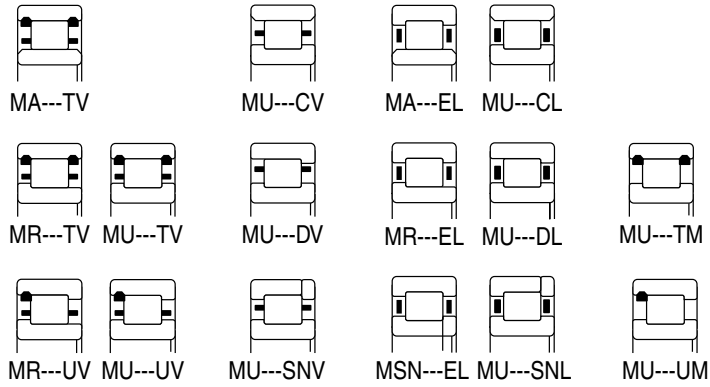
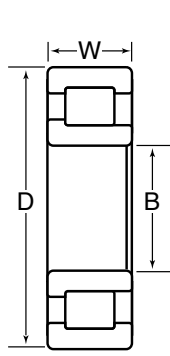

Basic Bearing Number	B		D		W		Radial Load Ratings — lbs./N									
	Bore Diameter	Outside Diameter		Width	One Piece Steel Cage				Composite Steel Cage		X Bar Steel Cage		Full Complement (No Cage)			
		Standard Style	"A" * Style		Outer Ring Assemblies		Inner Ring Assemblies		Dynamic	Static	Dynamic	Static	Dynamic	Static	Dynamic	Static
	Inch/mm		Dynamic	Static	Dynamic	Static	Dynamic	Static								
1203	0.6693 17.000	1.5748 40.000	1.5758 40.025	0.4724 12.000	3950 17500	3300 14700										
1204	0.7874 20.000	1.8504 47.000	1.8514 47.026	0.5512 14.000	4500 20100	4100 18300										
5204	0.7874 20.000	1.8504 47.000	1.8514 47.026	0.8125 20.638	7400 33000	7750 34500					7800 34500	8350 37000	9000 40000	10100 45000		
1304	0.7874 20.000	2.0472 52.000	2.0482 52.024	0.5906 15.000	5950 26400	5150 22900			6350 28100	5600 24900						
7304	0.7874 20.000	2.0472 52.000	2.0482 52.024	0.7087 18.000												
5304	0.7874 20.000	2.0472 52.000	2.0482 52.024	0.8750 22.225	9150 41000	8950 40000										
1205	0.9843 25.000	2.0472 52.000	2.0482 52.024	0.5906 15.000	5700 25400	5750 25600	5700 25400	5750 25600	6300 28100	6600 29300	6300 28100	6600 29300	7200 32000	7800 35000		
5205	0.9843 25.000	2.0472 52.000	2.0482 52.024	0.8125 20.638					8600 38500	9750 43500			9800 43500	11600 51500		
1305	0.9843 25.000	2.4409 62.000	2.4421 62.029	0.6693 17.000	8000 35500	7000 31000	8000 35500	7000 31000	8550 38000	7650 34000			9600 42500	8900 39500		
7305	0.9843 25.000	2.4409 62.000	2.4421 62.029	0.8268 21.000					11300 50500	11000 49000						
5305	0.9843 25.000	2.4409 62.000	2.4421 62.029	1.0000 25.400	12900 57000	12900 57500			13700 61000	14100 62500						
1006	1.1811 30.000	2.1654 55.000	2.1665 55.029	0.5118 13.000												
1206	1.1811 30.000	2.4409 62.000	2.4421 62.029	0.6299 16.000	7900 35000	7900 35000	7900 35000	7900 35000	8300 37000	8450 37500			9550 42500	10100 45000		
5206	1.1811 30.000	2.4409 62.000	2.4421 62.029	0.9375 23.812	11800 52500	12500 56000	12400 55500	14200 63000	12400 55500	14200 63000			14200 63000	16100 71500		
1306	1.1811 30.000	2.8346 72.000	2.8359 72.032	0.7480 19.000	10500 47000	10200 45500	10500 47000	10200 45500	11100 49500	11000 49000			12300 54500	12600 56000		
7306	1.1811 30.000	2.8346 72.000	2.8359 72.032	0.9055 23.000	13800 61500	14500 64500			14600 65000	15600 69500	13800 61500	14500 64500	16100 71500	17800 79500		
5306	1.1811 30.000	2.8346 72.000	2.8359 72.032	1.1875 23.000	15800 70500	17200 76500	16800 75000	18700 83000	17800 79000	20100 89500			19600 87500	23000 102000		
1007	1.3780 35.000	2.4409 62.000	2.4421 62.029	0.5512 14.000												

* Oversize outer ring for heavy press fit in standard housing bore.

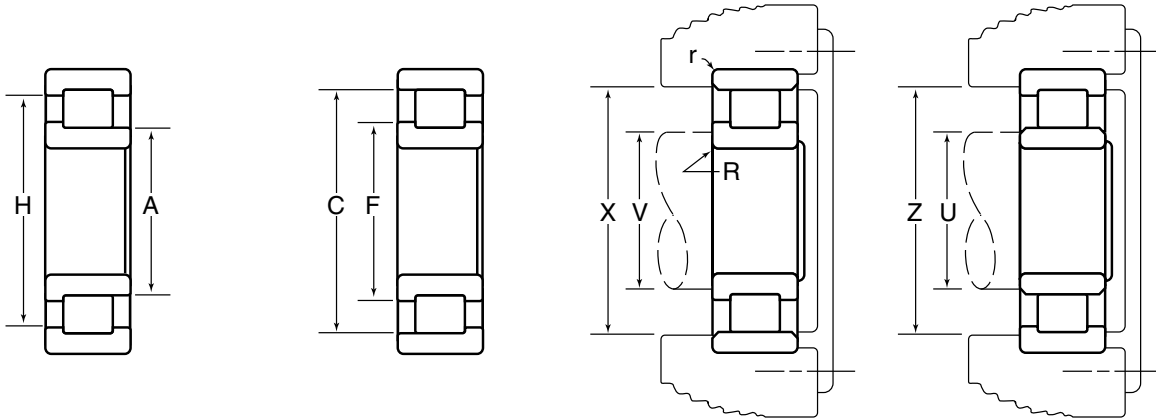

Basic Bearing Number	A	C	F	H	R	r	U	V	X	Z	Basic Bearing Number
	Inner Ring O.D.	Outer Ring I.D.	Inner Ring Rib O.D.	Outer Ring Rib I.D.	Maximum * Fillet Radius		Minimum Shaft Shoulder Diameter		Maximum Housing Shoulder Diameter		
					Shaft	Housing	Plain Rings	Rib Rings	Plain Rings	Rib Rings	
	Inch/mm										
1203	0.872 22.14	1.371 34.83	0.956 24.28	1.286 32.66	0.025 0.64	0.025 0.64	0.80 20.3	0.87 22.1	1.43 36.3	1.37 34.8	1203
1204	1.108 28.14	1.608 40.84	1.193 30.30	1.523 38.68	0.040 1.02	0.040 1.02	1.02 25.9	1.10 27.9	1.68 42.7	1.60 40.6	1204
5204	1.108 28.14	1.608 40.84	1.193 30.30	1.523 38.68	0.040 1.02	0.040 1.02	1.02 25.9	1.10 27.9	1.68 42.7	1.60 40.6	5204
1304	1.101 27.97	1.731 43.97	1.211 30.76	1.629 41.38	0.040 1.02	0.040 1.02	1.02 25.9	1.10 27.9	1.82 46.2	1.73 43.9	1304
7304	1.101 27.97	1.731 43.97	1.211 30.76	1.629 41.38	0.040 1.02	0.040 1.02	1.02 25.9	1.10 27.9	1.82 46.2	1.73 43.9	7304
5304	1.101 27.97	1.731 43.97	1.211 30.76	1.629 41.38	0.040 1.02	0.040 1.02	1.02 25.9	1.10 27.9	1.82 46.2	1.73 43.9	5304
1205	1.266 32.16	1.766 44.86	1.351 34.32	1.691 42.95	0.040 1.02	0.040 1.02	1.20 30.5	1.26 32.0	1.85 47.0	1.76 44.7	1205
5205	1.266 32.16	1.766 44.86	1.351 34.32	1.691 42.95	0.040 1.02	0.040 1.02	1.20 30.5	1.26 32.0	1.85 47.0	1.76 44.7	5205
1305	1.338 33.99	2.103 53.42	1.476 37.49	1.974 50.14	0.040 1.02	0.040 1.02	1.24 31.5	1.33 33.8	2.20 55.9	2.10 53.3	1305
7305	1.338 33.99	2.103 53.42	1.476 37.49	1.974 50.14	0.040 1.02	0.040 1.02	1.24 31.5	1.33 33.8	2.20 55.9	2.10 53.3	7305
5305	1.338 33.99	2.103 53.42	1.476 37.49	1.974 50.14	0.040 1.02	0.040 1.02	1.24 31.5	1.33 33.8	2.20 55.9	2.10 53.3	5305
1006	1.451 36.86	1.909 48.49	1.551 39.40	1.810 45.97	0.040 1.02	0.040 1.02	1.38 35.1	1.45 36.8	1.98 50.3	1.90 48.3	1006
1206	1.499 38.07	2.129 54.08	1.609 40.87	2.027 51.49	0.040 1.02	0.040 1.02	1.42 36.1	1.49 37.8	2.22 56.4	2.12 53.8	1206
5206	1.499 38.07	2.129 54.08	1.609 40.87	2.027 51.49	0.040 1.02	0.040 1.02	1.42 36.1	1.49 37.8	2.22 56.4	2.12 53.8	5206
1306	1.602 40.69	2.378 60.40	1.742 44.25	2.239 56.87	0.060 1.52	0.040 1.02	1.49 37.8	1.60 40.6	2.52 64.0	2.37 60.2	1306
7306	1.602 40.69	2.378 60.40	1.742 44.25	2.239 56.87	0.060 1.52	0.040 1.02	1.49 37.8	1.60 40.6	2.52 64.0	2.37 60.2	7306
5306	1.602 40.69	2.378 60.40	1.742 44.25	2.239 56.87	0.060 1.52	0.040 1.02	1.49 37.8	1.60 40.6	2.52 64.0	2.37 60.2	5306
1007	1.660 42.16	2.160 54.86	1.760 44.70	2.060 52.32	0.040 1.02	0.040 1.02	1.59 40.4	1.66 42.2	2.24 56.9	2.16 54.9	1007

* The maximum fillet on the shaft or in the housing that the bearing corner will clear.

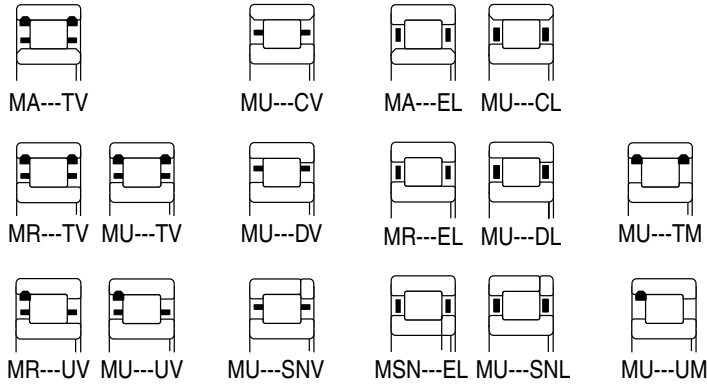
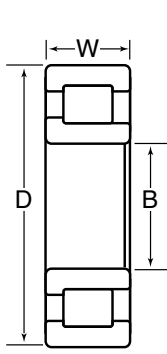

Basic Bearing Number	B		D		W		Radial Load Ratings — lbs./N							
	Bore Diameter	Outside Diameter		Width	One Piece Steel Cage				Composite Steel Cage		X Bar Steel Cage		Full Complement (No Cage)	
		Standard Style	"A" * Style		Outer Ring Assemblies		Inner Ring Assemblies		Dynamic	Static	Dynamic	Static	Dynamic	Static
	Inch/mm		Dynamic	Static	Dynamic	Static	Dynamic	Static						
1207	1.3780 35.000	2.8346 72.000	2.8359 72.032	0.6693 17.000	9050 40500	8900 39500	9050 40500	8900 39500	9550 42500	9550 42500	9550 42500	9550 42500	10900 48500	11400 51000
5207	1.3780 35.000	2.8346 72.000	2.8359 72.032	1.0625 26.988	14800 66000	16700 74000			15600 69000	17900 79500	15600 69000	17900 79500	17800 79500	21400 95500
1307	1.3780 35.000	3.1496 80.000	3.1510 80.035	0.8268 21.000	13200 59000	13500 60000	14000 62000	14600 65000	14000 62000	14600 65000	14000 62000	14600 65000	16200 72000	17700 78500
7307	1.3780 35.000	3.1496 80.000	3.1510 80.035	1.0236 26.000					18100 80500	20300 90000			20900 93000	24600 110000
5307	1.3780 35.000	3.1496 80.000	3.1510 80.035	1.3750 34.925					20800 92500	24300 108000			24000 107000	29500 131000
1008	1.5748 40.000	2.6772 68.000	2.6785 68.034	0.5906 15.000										
1208	1.5748 40.000	3.1496 80.000	3.1510 80.035	0.7087 18.000	10800 48000	11000 49000	10800 48000	11000 49000	11300 50500	11800 52500	11300 50500	11800 52500	12900 57000	13900 62000
5208	1.5748 40.000	3.1496 80.000	3.1510 80.035	1.1875 30.162	17700 79000	20900 93000			19600 87000	23800 106000	19600 87000	23800 106000	22300 99000	28300 126000
1308	1.5748 40.000	3.5433 90.000	3.5449 90.040	0.9055 23.000	16700 74000	16800 74500	16700 74000	16800 74500	17600 78500	18100 80500	16700 74000	16800 74500	19500 86500	20600 92000
7308	1.5748 40.000	3.5433 90.000	3.5449 90.040	1.1811 30.000					24700 110000	27800 124000	23300 104000	25800 115000	27300 121000	32000 141000
5308	1.5748 40.000	3.5433 90.000	3.5449 90.040	1.4375 36.512	26400 117000	30000 134000	27800 124000	32500 145000	27800 124000	32500 145000	26300 117000	30000 134000		
1009	1.7717 45.000	2.9528 75.000	2.9542 75.037	0.6299 16.000			8400 37500	10000 44500						
1209	1.7717 45.000	3.3465 85.000	3.3480 85.039	0.7480 19.000	11900 53000	13000 57500	12500 55500	13800 61500	13000 58000	14600 65000	13000 58000	14600 65000	14600 65000	17000 76000
5209	1.7717 45.000	3.3465 85.000	3.3480 85.039	1.1875 30.162					21200 94500	27300 122000	21200 94500	27300 122000		
1309	1.7717 45.000	3.9370 100.000	3.9388 100.046	0.9843 25.000	19600 87000	20500 91000	20700 92000	22000 98000	21800 97000	23600 105000	20700 92000	22000 98000	23900 106000	26800 119000
7309	1.7717 45.000	3.9370 100.000	3.9388 100.046	1.2205 31.000					27700 123000	32000 143000	26300 117000	30000 134000	30500 135000	36500 162000
5309	1.7717 45.000	3.9370 100.000	3.9388 100.046	1.5625 39.688										
1010	1.9685 50.000	3.1496 80.000	3.1510 80.035	0.6299 16.000			8600 38000	10600 47000	8600 38000	10600 47000				

* Oversize outer ring for heavy press fit in standard housing bore.

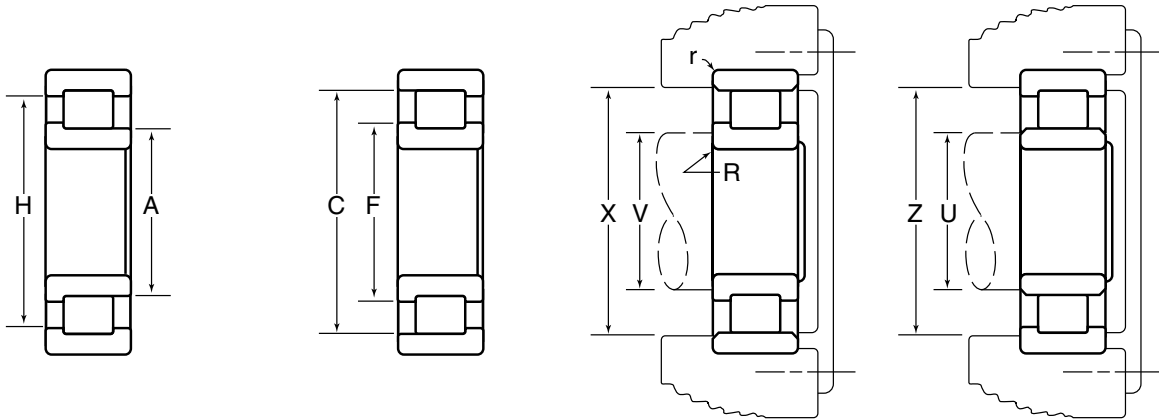

Basic Bearing Number	A	C	F	H	R	r	U	V	X	Z	Basic Bearing Number
	Inner Ring O.D.	Outer Ring I.D.	Inner Ring Rib O.D.	Outer Ring Rib I.D.	Maximum * Fillet Radius		Minimum Shaft Shoulder Diameter		Maximum Housing Shoulder Diameter		
					Shaft	Housing	Plain Rings	Rib Rings	Plain Rings	Rib Rings	
	Inch/mm										
1207	1.731 43.97	2.460 62.48	1.862 47.29	2.343 59.51	0.040 1.02	0.040 1.02	1.64 41.7	1.73 43.9	2.57 65.3	2.46 62.5	1207
5207	1.731 43.97	2.460 62.48	1.862 47.29	2.343 59.51	0.040 1.02	0.040 1.02	1.64 41.7	1.73 43.9	2.57 65.3	2.46 62.5	5207
1307	1.844 46.84	2.675 67.94	1.995 50.67	2.538 64.47	0.060 1.52	0.060 1.52	1.72 43.7	1.84 46.7	2.81 71.4	2.67 67.8	1307
7307	1.844 46.84	2.675 67.94	1.995 50.67	2.538 64.47	0.060 1.52	0.060 1.52	1.72 43.7	1.84 46.7	2.81 71.4	2.67 67.8	7307
5307	1.844 46.84	2.675 67.94	1.995 50.67	2.538 64.47	0.060 1.52	0.060 1.52	1.72 43.7	1.84 46.7	2.81 71.4	2.67 67.8	5307
1008	1.877 47.68	2.377 60.38	1.976 50.19	2.276 57.81	0.040 1.02	0.040 1.02	1.80 45.7	1.87 47.5	2.47 62.7	2.37 60.2	1008
1208	1.966 49.94	2.741 69.62	2.104 53.44	2.615 66.42	0.060 1.52	0.040 1.02	1.86 47.2	1.96 49.8	2.87 72.9	2.74 69.6	1208
5208	1.966 49.94	2.741 69.62	2.104 53.44	2.615 66.42	0.060 1.52	0.040 1.02	1.86 47.2	1.96 49.8	2.87 72.9	2.74 69.6	5208
1308	2.059 52.30	3.058 77.67	2.244 57.00	2.887 73.33	0.060 1.52	0.060 1.52	1.93 49.0	2.05 52.1	3.20 81.3	3.05 77.5	1308
7308	2.059 52.30	3.058 77.67	2.244 57.00	2.887 73.33	0.060 1.52	0.060 1.52	1.93 49.0	2.05 52.1	3.20 81.3	3.05 77.5	7308
5308	2.059 52.30	3.058 77.67	2.244 57.00	2.887 73.33	0.060 1.52	0.060 1.52	1.93 49.0	2.05 52.1	3.20 81.3	3.05 77.5	5308
1009	2.082 52.88	2.644 67.16	2.182 55.42	2.544 64.62	0.040 1.02	0.040 1.02	2.00 50.8	2.08 52.8	2.73 69.3	2.64 67.1	1009
1209	2.186 55.52	2.952 74.98	2.324 59.03	2.827 71.81	0.060 1.52	0.040 1.02	2.08 52.8	2.18 55.4	3.08 78.2	2.95 74.9	1209
5209	2.186 55.52	2.952 74.98	2.324 59.03	2.827 71.81	0.060 1.52	0.040 1.02	2.08 52.8	2.18 55.4	3.08 78.2	2.95 74.9	5209
1309	2.337 59.36	3.390 86.11	2.532 64.31	3.208 81.48	0.080 2.03	0.060 1.52	2.20 55.9	2.33 59.2	3.56 90.4	3.39 86.1	1309
7309	2.337 59.36	3.390 86.11	2.532 64.31	3.208 81.48	0.080 2.03	0.060 1.52	2.20 55.9	2.33 59.2	3.56 90.4	3.39 86.1	7309
5309	2.337 59.36	3.390 86.11	2.532 64.31	3.208 81.48	0.080 2.03	0.060 1.52	2.20 55.9	2.33 59.2	3.56 90.4	3.39 86.1	5309
1010	2.279 57.89	2.841 72.16	2.379 60.43	2.741 69.62	0.060 1.52	0.040 1.02	2.21 56.1	2.27 57.7	2.93 74.4	2.84 72.1	1010

* The maximum fillet on the shaft or in the housing that the bearing corner will clear.

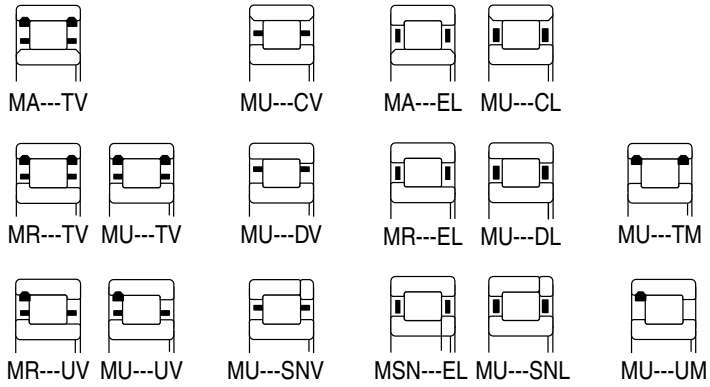
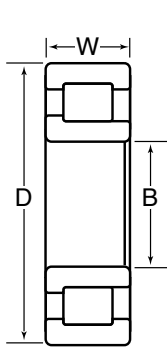

Basic Bearing Number	B			D			W			Radial Load Ratings — lbs./N						
	Bore Diameter	Outside Diameter		Width	One Piece Steel Cage				Composite Steel Cage		X Bar Steel Cage		Full Complement (No Cage)			
		Standard Style	"A" * Style		Outer Ring Assemblies		Inner Ring Assemblies		Dynamic	Static	Dynamic	Static	Dynamic	Static	Dynamic	Static
	Inch/mm			Dynamic	Static	Dynamic	Static	Dynamic	Static	Dynamic	Static	Dynamic	Static	Dynamic	Static	
1210	1.9685 50.000	3.5433 90.000	3.5449 90.040	1.7874 20.000	12700 56500	14500 64500					13200 58500	15300 68000	13200 58500	15300 68000	15200 67500	18600 82500
5210	1.9685 50.000	3.5433 90.000	3.5449 90.040	1.1875 30.162			19400 86500	25100 112000	21100 94000	28100 125000	21100 94000	28100 125000				
1310	1.9685 50.000	4.3307 110.000	4.3329 110.056	1.0630 27.000	24500 109000	26500 118000	24500 109000	26500 118000	24500 109000	26500 118000	24500 109000	26500 118000	28400 126000	32000 143000		
7310	1.9685 50.000	4.3307 110.000	4.3329 110.056	1.2992 33.000					31500 140000	36500 163000	31500 140000	36500 163000				
5310	1.9685 50.000	4.3307 110.000	4.3329 110.056	1.7500 44.450					37500 167000	46000 204000						
1911	2.1654 55.000	3.1496 80.000	3.1510 80.035	0.5118 13.000												
1011	2.1654 55.000	3.5433 90.000	3.5449 90.040	0.7087 18.000			10700 47500	13300 59500	10700 47500	13300 59500	11600 51500	14300 64000				
1211	2.1654 55.000	3.9370 100.000	3.9388 100.046	0.8268 21.000	14600 64500	16700 74000			15800 70500	18600 83000	15800 70500	18600 83000	18200 81000	22600 100000		
5211	2.1654 55.000	3.9370 100.000	3.9388 100.046	1.3125 33.338	23700 105000	31000 139000			25700 114000	35000 155000	25700 114000	35000 155000				
1311	2.1654 55.000	4.7244 120.000	4.7266 120.056	1.1417 29.000	25400 113000	26600 118000	26800 119000	28600 127000	28200 126000	30500 137000			31000 138000	35000 155000		
7311	2.1654 55.000	4.7244 120.000	4.7266 120.056	1.4173 36.000					38500 170000	45500 202000						
5311	2.1654 55.000	4.7244 120.000	4.7266 120.056	1.9375 49.212					49000 218000	62500 277000				54000 239000	70500 315000	
1912	2.3622 60.000	3.3465 85.000	3.3480 85.039	0.5118 13.000												
1012	2.3622 60.000	3.7402 95.000	3.7419 95.044	0.7087 18.000			11300 50000	14700 65000	11300 50000	14700 65000						
1212	2.3622 60.000	4.3307 110.000	4.3329 110.056	0.8661 22.000	18500 82500	20700 92000	19300 86000	21900 97500	19300 86000	21900 97500	19300 86000	21900 97500	21700 96500	25600 114000		
5212	2.3622 60.000	4.3307 110.000	4.3329 110.056	1.4375 36.512	30500 136000	39500 175000			33500 148000	44000 196000	33500 148000	44000 196000	37500 167000	51500 229000		
1312	2.3622 60.000	5.1181 130.000	5.1204 130.058	1.2205 31.000	30500 137000	33000 147000	32500 144000	35500 158000	34000 152000	38000 169000	32500 144000	35500 158000	37500 167000	43000 192000		
7312	2.3622 60.000	5.1181 130.000	5.1204 130.058	1.4961 38.000			42500 189000	50000 223000	44500 199000	53500 239000	42500 189000	50000 223000				

* Oversize outer ring for heavy press fit in standard housing bore.

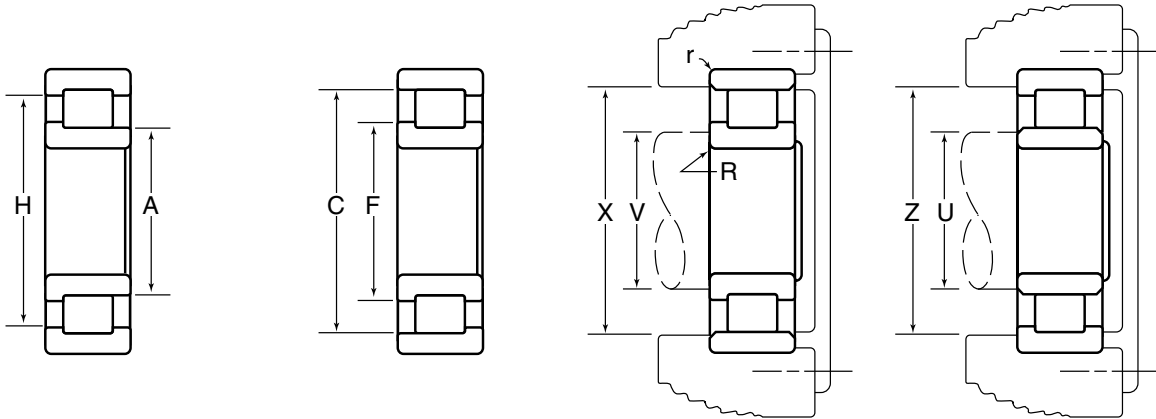

Basic Bearing Number	A	C	F	H	R	r	U	V	X	Z	Basic Bearing Number
	Inner Ring O.D.	Outer Ring I.D.	Inner Ring Rib O.D.	Outer Ring Rib I.D.	Maximum * Fillet Radius		Minimum Shaft Shoulder Diameter		Maximum Housing Shoulder Diameter		
					Shaft	Housing	Plain Rings	Rib Rings	Plain Rings	Rib Rings	
	Inch/mm										
1210	2.380 60.45	3.132 79.55	2.518 63.96	3.018 76.66	0.060 1.52	0.040 1.02	2.27 57.7	2.38 60.5	3.26 82.8	3.13 79.5	1210
5210	2.380 60.45	3.132 79.55	2.518 63.96	3.018 76.66	0.060 1.52	0.040 1.02	2.27 57.7	2.38 60.5	3.26 82.8	3.13 79.5	5210
1310	2.565 65.15	3.720 94.49	2.781 70.64	3.518 89.36	0.080 2.03	0.080 2.03	2.40 61.0	2.56 65.0	3.90 99.1	3.72 94.5	1310
7310	2.565 65.15	3.720 94.49	2.781 70.64	3.518 89.36	0.080 2.03	0.080 2.03	2.40 61.0	2.56 65.0	3.90 99.1	3.72 94.5	7310
5310	2.565 65.15	3.720 94.49	2.781 70.64	3.518 89.36	0.080 2.03	0.080 2.03	2.40 61.0	2.56 65.0	3.90 99.1	3.72 94.5	5310
1911	2.430 61.72	2.889 73.38	2.530 64.26	2.789 70.84	0.040 1.02	0.040 1.02	2.36 59.9	2.43 61.7	2.96 75.2	2.88 73.2	1911
1011	2.539 64.49	3.171 80.54	2.665 67.69	3.045 77.34	0.060 1.52	0.040 1.02	2.44 62.0	2.53 64.3	3.29 83.6	3.17 80.5	1011
1211	2.634 66.90	3.465 88.01	2.785 70.74	3.328 84.53	0.080 2.03	0.060 1.52	2.52 64.0	2.63 66.8	3.60 91.4	3.46 87.9	1211
5211	2.634 66.90	3.465 88.01	2.785 70.74	3.328 84.53	0.080 2.03	0.060 1.52	2.52 64.0	2.63 66.8	3.60 91.4	3.46 87.9	5211
1311	2.812 71.42	4.079 103.61	3.045 77.34	3.860 98.04	0.080 2.03	0.080 2.03	2.62 66.5	2.81 71.4	4.28 108.7	4.07 103.4	1311
7311	2.812 71.42	4.079 103.61	3.045 77.34	3.860 98.04	0.080 2.03	0.080 2.03	2.62 66.5	2.81 71.4	4.28 108.7	4.07 103.4	7311
5311	2.812 71.42	4.079 103.61	3.045 77.34	3.860 98.04	0.080 2.03	0.080 2.03	2.62 66.5	2.81 71.4	4.28 108.7	4.07 103.4	5311
1912	2.630 66.80	3.089 78.46	2.730 69.34	2.989 75.92	0.040 1.02	0.040 1.02	2.56 65.0	2.63 66.8	3.16 80.3	3.08 78.2	1912
1012	2.736 69.49	3.368 85.55	2.862 72.69	3.242 82.35	0.060 1.52	0.040 1.02	2.64 67.1	2.73 69.3	3.49 88.6	3.36 85.3	1012
1212	2.850 72.39	3.849 97.76	3.029 76.94	3.681 93.50	0.080 2.03	0.060 1.52	2.73 69.3	2.85 72.4	3.99 101.3	3.84 97.5	1212
5212	2.850 72.39	3.849 97.76	3.029 76.94	3.681 93.50	0.080 2.03	0.060 1.52	2.73 69.3	2.85 72.4	3.99 101.3	3.84 97.5	5212
1312	3.053 77.55	4.429 112.50	3.308 84.02	4.187 106.35	0.100 2.54	0.080 2.03	2.87 72.9	3.05 77.5	4.64 117.9	4.42 112.3	1312
7312	3.053 77.55	4.429 112.50	3.308 84.02	4.187 106.35	0.100 2.54	0.080 2.03	2.87 72.9	3.05 77.5	4.64 117.9	4.42 112.3	7312

* The maximum fillet on the shaft or in the housing that the bearing corner will clear.

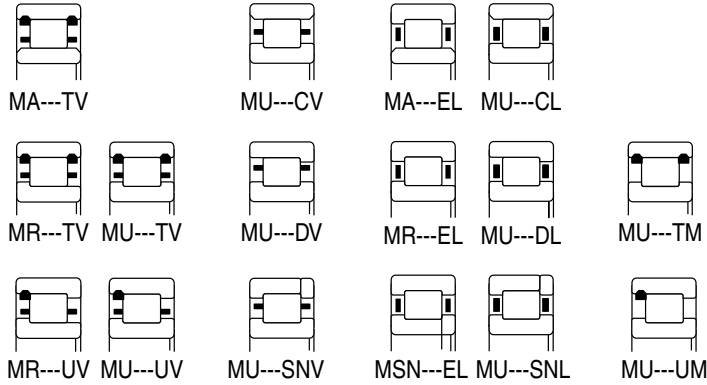
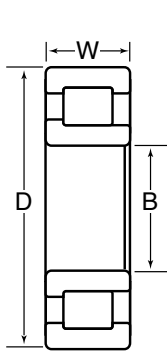

Basic Bearing Number	B		D		W		Radial Load Ratings — lbs./N							
	Bore Diameter	Outside Diameter		Width	One Piece Steel Cage				Composite Steel Cage		X Bar Steel Cage		Full Complement (No Cage)	
		Standard Style	"A" * Style		Outer Ring Assemblies		Inner Ring Assemblies		Dynamic	Static	Dynamic	Static	Dynamic	Static
	Inch/mm				Dynamic	Static	Dynamic	Static	Dynamic	Static	Dynamic	Static	Dynamic	Static
5312	2.3622	5.1181	5.1204	2.1250					60000	78000	57000	73000		
	60.000	130.000	130.058	53.975					266000	350000	253000	325000		
1913	2.5591	3.5433	3.5449	0.5118										
	65.000	90.000	90.040	13.000										
1013	2.5591	3.9370	3.9388	0.7087			10900	14300	11900	16000				
	65.000	100.000	100.046	18.000			48500	63500	53000	71000				
1213	2.5591	4.7244	4.7266	0.9055					21800	26300	21800	26300	21800	26300
	65.000	120.000	120.056	23.000					97000	117000	97000	117000	97000	117000
5213	2.5591	4.7244	4.7266	1.5000	33000	45000			34500	47500	34500	47500	40000	57500
	65.000	120.000	120.056	38.100	147000	200000			153000	211000	153000	211000	177000	265000
1313	2.5591	5.5118	5.5141	1.2992	38000	42500	38000	42500	38000	42500	38000	42500	44000	51500
	65.000	140.000	140.058	33.000	170000	189000	170000	189000	170000	189000	170000	189000	196000	230000
7313	2.5591	5.5118	5.5141	1.5748					48500	57500	48500	57500		
	65.000	140.000	140.058	40.000					215000	256000	215000	256000		
5313	2.5591	5.5118	5.5141	2.3125					67500	88500			78000	107000
	65.000	140.000	140.058	58.738					300000	395000			345000	475000
1914	2.7559	3.9370	3.9388	0.6299										
	70.000	100.000	100.046	16.000										
1014	2.7559	4.3307	4.3329	0.7874			14300	18000	14300	18000	14800	18800		
	70.000	110.000	110.056	20.000			63500	80000	63500	80000	65500	83500		
1214	2.7559	4.9213	4.9236	0.9449	23200	27800	23200	27800	23200	27800	24200	29400	28800	37000
	70.000	125.000	125.059	24.000	103000	124000	103000	124000	103000	124000	107000	131000	128000	165000
5214	2.7559	4.9213	4.9236	1.5625	38000	53000			38000	53000				
	70.000	125.000	125.059	39.688	170000	235000			170000	235000				
1314	2.7559	5.9055	5.9081	1.3780			43000	48500	43000	48500	43000	48500	49500	58500
	70.000	150.000	150.066	35.000			191000	215000	191000	215000	191000	215000	221000	261000
7314	2.7559	5.9055	5.9081	1.6929					54500	65500	54500	65500	63000	79500
	70.000	150.000	150.066	43.000					242000	291000	242000	291000	280000	355000
5314	2.7559	5.9055	5.9081	2.5000										
	70.000	150.000	150.066	63.500										
1915	2.9528	4.1339	4.1358	0.6299										
	75.000	105.000	105.049	16.000										
1015	2.9528	4.5276	4.5298	0.7874			14600	18900	14600	18900	15600	20500		
	75.000	115.000	115.057	20.000			65000	84000	65000	84000	69000	91000		
1215	2.9528	5.1181	5.1204	0.9843	24000	29500			25000	31000			28700	37500
	75.000	130.000	130.058	25.000	107000	131000			111000	138000			127000	166000

* Oversize outer ring for heavy press fit in standard housing bore.

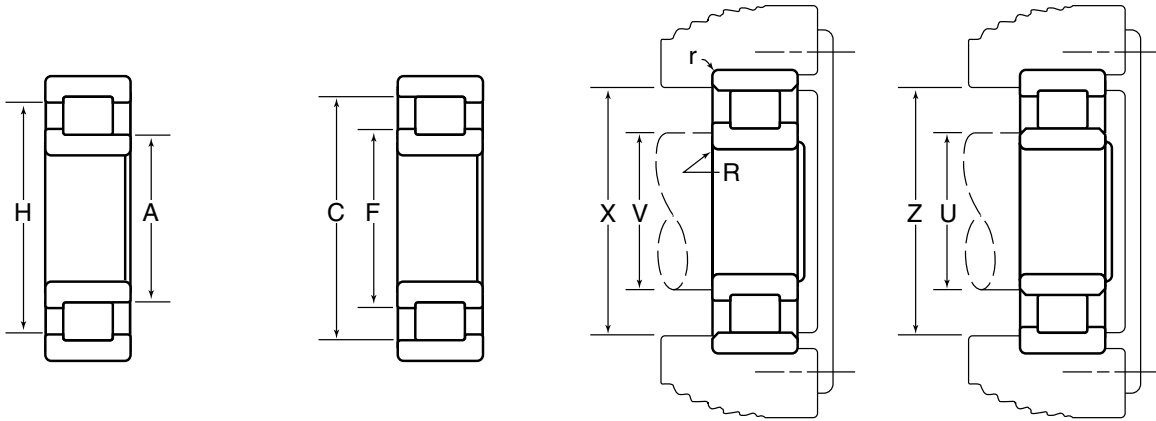

Basic Bearing Number	A	C	F	H	R	r	U	V	X	Z	Basic Bearing Number
	Inner Ring O.D.	Outer Ring I.D.	Inner Ring Rib O.D.	Outer Ring Rib I.D.	Maximum * Fillet Radius		Minimum Shaft Shoulder Diameter		Maximum Housing Shoulder Diameter		
					Shaft	Housing	Plain Rings	Rib Rings	Plain Rings	Rib Rings	
	Inch/mm										
5312	3.053 77.55	4.429 112.50	3.308 84.02	4.187 106.35	0.100 2.54	0.080 2.03	2.87 72.9	3.05 77.5	4.64 117.9	4.42 112.3	5312
1913	2.875 71.76	3.284 83.41	2.925 74.30	3.184 80.87	0.040 1.02	0.040 1.02	2.76 70.1	2.82 71.6	3.36 85.3	3.28 83.3	1913
1013	2.933 74.50	3.565 90.55	3.060 77.72	3.439 87.35	0.060 1.52	0.040 1.02	2.84 72.1	2.93 74.4	3.69 93.7	3.56 90.4	1013
1213	3.166 80.42	4.166 105.82	3.360 85.34	3.986 101.24	0.100 2.54	0.060 1.52	3.03 77.0	3.16 80.3	4.33 110.0	4.16 105.7	1213
5213	3.166 80.42	4.166 105.82	3.360 85.34	3.986 101.24	0.100 2.54	0.060 1.52	3.03 77.0	3.16 80.3	4.33 110.0	4.16 105.7	5213
1313	3.294 83.67	4.778 121.36	3.571 90.70	4.515 114.68	0.100 2.54	0.080 2.03	3.10 78.7	3.29 83.6	5.00 127.0	4.77 121.2	1313
7313	3.294 83.67	4.778 121.36	3.571 90.70	4.515 114.68	0.100 2.54	0.080 2.03	3.10 78.7	3.29 83.6	5.00 127.0	4.77 121.2	7313
5313	3.294 83.67	4.778 121.36	3.571 90.70	4.515 114.68	0.100 2.54	0.080 2.03	3.10 78.7	3.29 83.6	5.00 127.0	4.77 121.2	5313
1914	3.070 77.98	3.633 92.28	3.182 80.82	3.520 89.41	0.040 1.02	0.040 1.02	2.99 75.9	3.07 78.0	3.72 94.5	3.63 92.2	1914
1014	3.157 80.19	3.933 99.90	3.312 84.12	3.779 95.99	0.080 2.03	0.040 1.02	3.05 77.5	3.15 80.0	4.07 103.4	3.93 99.8	1014
1214	3.338 84.79	4.391 111.53	3.528 89.61	4.213 107.01	0.100 2.54	0.060 1.52	3.22 81.8	3.33 84.6	4.55 115.6	4.39 111.5	1214
5214	3.338 84.79	4.391 111.53	3.528 89.61	4.213 107.01	0.100 2.54	0.060 1.52	3.22 81.8	3.33 84.6	4.55 115.6	4.39 111.5	5214
1314	3.512 89.20	5.094 129.39	3.808 96.72	4.811 122.20	0.125 3.18	0.080 2.03	3.32 84.3	3.51 89.2	5.34 135.6	5.09 129.3	1314
7314	3.512 89.20	5.094 129.39	3.808 96.72	4.811 122.20	0.125 3.18	0.080 2.03	3.32 84.3	3.51 89.2	5.34 135.6	5.09 129.3	7314
5314	3.512 89.20	5.094 129.39	3.808 96.72	4.811 122.20	0.125 3.18	0.080 2.03	3.32 84.3	3.51 89.2	5.34 135.6	5.09 129.3	5314
1915	3.265 82.93	3.828 97.23	3.377 85.78	3.716 94.39	0.040 1.02	0.040 1.02	3.18 80.8	3.26 82.8	3.92 99.6	3.82 97.0	1915
1015	3.355 85.22	4.131 104.93	3.510 89.15	3.977 101.02	0.080 2.03	0.040 1.02	3.25 82.6	3.35 85.1	4.27 108.5	4.13 104.9	1015
1215	3.505 89.03	4.558 115.77	3.695 93.85	4.380 111.25	0.100 2.54	0.060 1.52	3.37 85.6	3.50 88.9	4.73 120.1	4.55 115.6	1215

* The maximum fillet on the shaft or in the housing that the bearing corner will clear.

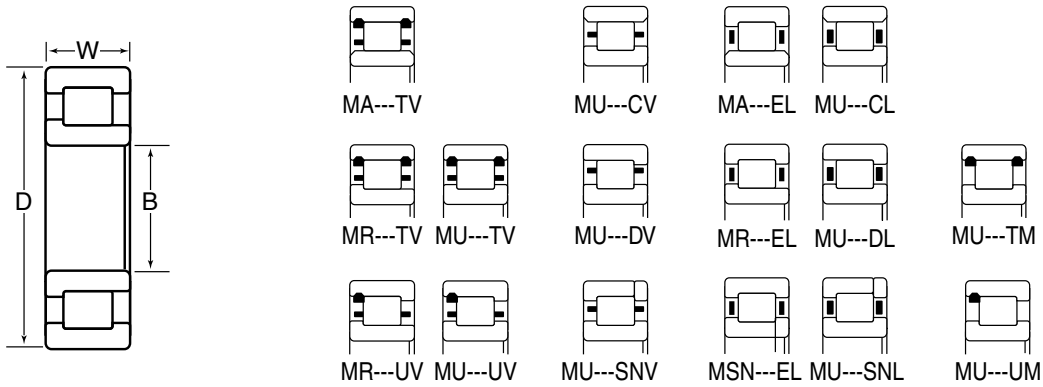

Basic Bearing Number	B		D		W	Radial Load Ratings — lbs./N									
	Bore Diameter	Outside Diameter		Width	One Piece Steel Cage				Composite Steel Cage		X Bar Steel Cage		Full Complement (No Cage)		
		Standard Style	"A" * Style		Outer Ring Assemblies		Inner Ring Assemblies		Dynamic	Static	Dynamic	Static	Dynamic	Static	Dynamic
	Inch/mm					Dynamic	Static	Dynamic	Static	Dynamic	Static	Dynamic	Static	Dynamic	Static
5215	2.9528 75.000	5.1181 130.000	5.1204 130.058	1.6250 41.275						43000 191000	62500 278000	43000 191000	62500 278000		
1315	2.9528 75.000	6.2992 160.000	6.3020 160.071	1.4567 37.000			45500 202000	50500 224000		45500 202000	50500 224000	45500 202000	50500 224000	52500 233000	61000 272000
7315	2.9528 75.000	6.2992 160.000	6.3020 160.071	1.8110 46.000						60000 267000	72500 320000				
5315	2.9528 75.000	6.2992 160.000	6.3020 160.071	2.6875 68.262											
1916	3.1496 80.000	4.3307 110.000	4.3329 110.056	0.6299 16.000											
1016	3.1496 80.000	4.9213 125.000	4.9236 125.059	0.8661 22.000						18500 82500	23900 107000	17600 78500	23500 104000		
1216	3.1496 80.000	5.5118 140.000	5.5141 140.058	1.0236 26.000	25600 114000	30500 136000				26700 119000	32500 144000	27700 123000	34000 151000	31000 137000	39000 174000
5216	3.1496 80.000	5.5118 140.000	5.5141 140.058	1.7500 44.450	44500 199000	62500 278000				46500 207000	66000 294000	48500 215000	69500 310000		
1316	3.1496 80.000	6.6929 170.000	6.6957 170.071	1.5354 39.000						54000 241000	62000 276000			59500 265000	70500 315000
7316	3.1496 80.000	6.6929 170.000	6.6957 170.071	1.9291 49.000											
5316	3.1496 80.000	6.6929 170.000	6.6957 170.071	2.6875 68.262						95000 420000	127000 565000				
1917	3.3465 85.000	4.7244 120.000	4.7266 120.056	0.7087 18.000											
1017	3.3465 85.000	5.1181 130.000	5.1204 130.058	0.8661 22.000			17800 79500	23000 103000		19000 84500	25100 112000	19600 87500	26200 117000		
1217	3.3465 85.000	5.9055 150.000	5.9081 150.066	1.1024 28.000	31000 139000	38000 169000				31000 139000	38000 169000	32500 145000	40000 178000	37500 167000	48500 216000
5217	3.3465 85.000	5.9055 150.000	5.9081 150.066	1.9375 49.212						55500 246000	79000 350000	57500 256000	83500 370000		
1317	3.3465 85.000	7.0866 180.000	7.0894 180.071	1.6142 41.000						54500 243000	61000 272000				
7317	3.3465 85.000	7.0866 180.000	7.0894 180.071	2.0079 51.000						75500 355000	92500 410000	75500 335000	92500 410000		
5317	3.3465 85.000	7.0866 180.000	7.0894 180.071	2.8750 73.025										122000 540000	172000 765000

* Oversize outer ring for heavy press fit in standard housing bore.

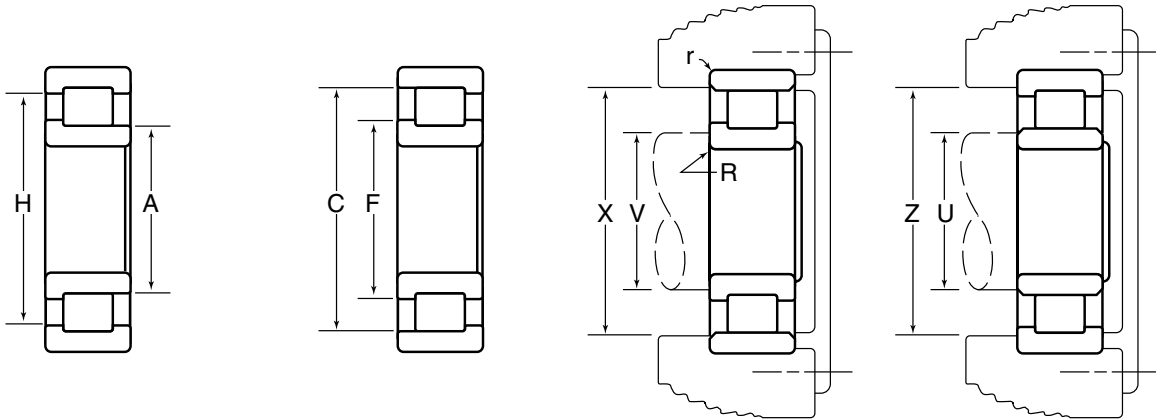

Basic Bearing Number	A	C	F	H	R	r	U	V	X	Z	Basic Bearing Number
	Inner Ring O.D.	Outer Ring I.D.	Inner Ring Rib O.D.	Outer Ring Rib I.D.	Maximum * Fillet Radius		Minimum Shaft Shoulder Diameter		Maximum Housing Shoulder Diameter		
					Shaft	Housing	Plain Rings	Rib Rings	Plain Rings	Rib Rings	
	Inch/mm										
5215	3.505 89.03	4.558 115.77	3.695 93.85	4.380 111.25	0.100 2.54	0.060 1.52	3.37 85.6	3.50 88.9	4.73 120.1	4.55 115.6	5215
1315	3.776 95.91	5.478 139.14	4.096 104.04	5.172 131.37	0.125 3.18	0.080 2.03	3.56 90.4	3.77 95.8	5.74 145.8	5.47 138.9	1315
7315	3.776 95.91	5.478 139.14	4.096 104.04	5.172 131.37	0.125 3.18	0.080 2.03	3.56 90.4	3.77 95.8	5.74 145.8	5.47 138.9	7315
5315	3.776 95.91	5.478 139.14	4.096 104.04	5.172 131.37	0.125 3.18	0.080 2.03	3.56 90.4	3.77 95.8	5.74 145.8	5.47 138.9	5315
1916	3.460 87.88	4.023 102.18	3.572 90.73	3.911 99.34	0.040 1.02	0.040 1.02	3.38 85.9	3.46 87.9	4.11 104.4	4.02 102.1	1916
1016	3.595 91.31	4.454 113.13	3.771 95.78	4.303 109.30	0.080 2.03	0.040 1.02	3.48 88.4	3.59 91.2	4.63 117.6	4.47 113.5	1016
1216	3.751 95.28	4.908 124.66	3.968 100.79	4.700 119.38	0.100 2.54	0.080 2.03	3.59 91.2	3.75 95.2	5.09 129.3	4.90 124.5	1216
5216	3.751 95.28	4.908 124.66	3.968 100.79	4.700 119.38	0.100 2.54	0.080 2.03	3.59 91.2	3.75 95.2	5.09 129.3	4.90 124.5	5216
1316	4.001 101.63	5.804 147.42	4.342 110.29	5.480 139.19	0.125 3.18	0.080 2.03	3.78 96.0	4.00 101.6	6.08 154.4	5.80 147.3	1316
7316	4.001 101.63	5.804 147.42	4.342 110.29	5.480 139.19	0.125 3.18	0.080 2.03	3.78 96.0	4.00 101.6	6.08 154.4	5.80 147.3	7316
5316	4.001 101.63	5.804 147.42	4.342 110.29	5.480 139.19	0.125 3.18	0.080 2.03	3.78 96.0	4.00 101.6	6.08 154.4	5.80 147.3	5316
1917	3.725 94.62	4.357 110.67	3.851 97.82	4.231 107.47	0.060 1.52	0.040 1.02	3.63 92.2	3.72 94.5	4.48 113.8	4.35 110.5	1917
1017	3.792 96.32	4.654 118.21	3.968 100.79	4.500 114.30	0.080 2.03	0.040 1.02	3.68 93.5	3.79 96.3	4.83 122.7	4.67 118.6	1017
1217	4.016 102.01	5.284 134.21	4.254 108.05	5.056 128.42	0.125 3.18	0.080 2.03	3.86 98.0	4.01 101.9	5.48 139.2	5.28 134.1	1217
5217	4.016 102.01	5.284 134.21	4.254 108.05	5.056 128.42	0.125 3.18	0.080 2.03	3.86 98.0	4.01 101.9	5.48 139.2	5.28 134.1	5217
1317	4.273 108.53	6.198 157.43	4.655 118.24	5.852 148.64	0.156 3.96	0.100 2.54	4.05 102.9	4.27 108.5	6.47 164.3	6.19 157.2	1317
7317	4.273 108.53	6.198 157.43	4.655 118.24	5.852 148.64	0.156 3.96	0.100 2.54	4.05 102.9	4.27 108.5	6.47 164.3	6.19 157.2	7317
5317	4.273 108.53	6.198 157.43	4.655 118.24	5.852 148.64	0.156 3.96	0.100 2.54	4.05 102.9	4.27 108.5	6.47 164.3	6.19 157.2	5317

* The maximum fillet on the shaft or in the housing that the bearing corner will clear.

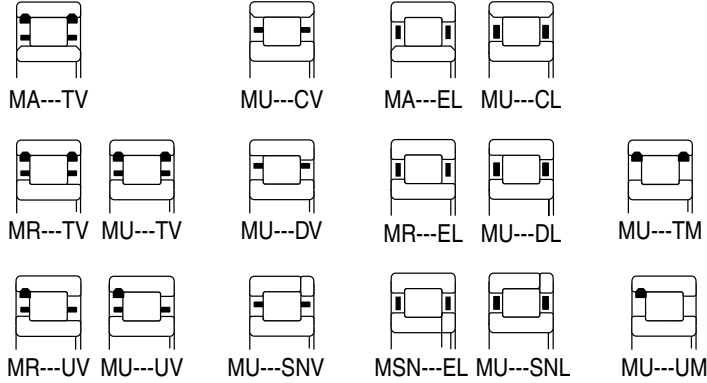
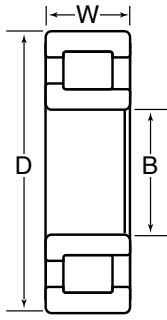

Basic Bearing Number	B		D		W		Radial Load Ratings — lbs./N									
	Bore Diameter	Outside Diameter		Width	One Piece Steel Cage				Composite Steel Cage		X Bar Steel Cage		Full Complement (No Cage)			
		Standard Style	"A" * Style		Outer Ring Assemblies		Inner Ring Assemblies		Dynamic	Static	Dynamic	Static	Dynamic	Static	Dynamic	Static
	Inch/mm				Dynamic	Static	Dynamic	Static								
1918	3.5433 90.000	4.9213 125.000	4.9236 125.059	0.7087 18.000												
1018	3.5433 90.000	5.5118 140.000	5.5141 140.058	0.9449 24.000												
1218	3.5433 90.000	6.2992 160.000	6.3020 160.071	1.1811 30.000			36500 163000	45000 200000	35000 156000	42500 189000	38000 170000	47500 211000	43000 192000	55000 246000		
5218	3.5433 90.000	6.2992 160.000	6.3020 160.071	2.0625 52.388	65000 290000	94000 420000						68000 300000	99000 440000			
1318	3.5433 90.000	7.4803 190.000	7.4833 190.076	1.6929 43.000			68500 305000	80000 355000	61500 273000	69500 310000	68500 305000	80000 355000				
7318	3.5433 90.000	7.4803 190.000	7.4833 190.076	2.1260 54.000												
5318	3.5433 90.000	7.4803 190.000	7.4833 190.076	2.8750 73.025							114000 510000	155000 690000				
1919	3.7402 95.000	5.1181 130.000	5.1204 130.058	0.7087 18.000												
1019	3.7402 95.000	5.7087 145.000	5.7113 145.067	0.9449 24.000												
1219	3.7402 95.000	6.6929 170.000	6.6957 170.071	1.2598 32.000							43000 192000	53500 238000				
5219	3.7402 95.000	6.6929 170.000	6.6957 170.071	2.1875 55.562					72000 320000	103000 460000						
1319	3.7402 95.000	7.8740 200.000	7.8771 200.078	1.7717 45.000					65000 289000	75500 335000	68500 305000	81000 360000				
7319	3.7402 95.000	7.8740 200.000	7.8771 200.078	2.2047 56.000							93500 415000	121000 540000				
5319	3.7402 95.000	7.8740 200.000	7.8771 200.078	3.0625 77.788							120000 535000	168000 745000				
1920	3.9370 100.000	5.5118 140.000	5.5141 140.058	0.7874 20.000												
1020	3.9370 100.000	5.9055 150.000	5.9081 150.066	0.9499 24.000			20300 90000	28700 128000								
1220	3.9370 100.000	7.0866 180.000	7.0894 180.071	1.3386 34.000					47500 211000	59000 263000						
5220	3.9370 100.000	7.0866 180.000	7.0894 180.071	2.3750 60.325	83000 370000	121000 540000					83000 370000	121000 540000				

* Oversize outer ring for heavy press fit in standard housing bore.

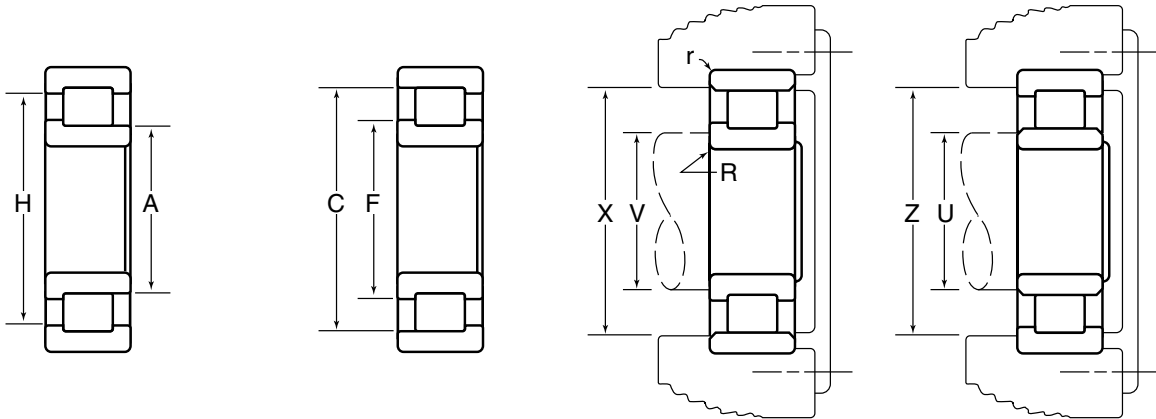

Basic Bearing Number	A	C	F	H	R	r	U	V	X	Z	Basic Bearing Number
	Inner Ring O.D.	Outer Ring I.D.	Inner Ring Rib O.D.	Outer Ring Rib I.D.	Maximum * Fillet Radius		Minimum Shaft Shoulder Diameter		Maximum Housing Shoulder Diameter		
					Shaft	Housing	Plain Rings	Rib Rings	Plain Rings	Rib Rings	
	Inch/mm										
1918	3.920 99.57	4.553 115.65	4.046 102.77	4.426 112.42	0.060 1.52	0.040 1.02	3.82 97.0	3.92 99.6	4.67 118.6	4.55 115.6	1918
1018	4.030 102.36	5.031 127.79	4.229 107.42	4.831 122.71	0.100 2.54	0.060 1.52	3.92 99.6	4.03 102.4	5.18 131.6	5.03 127.8	1018
1218	4.221 107.21	5.598 142.19	4.495 114.17	5.350 135.89	0.125 3.18	0.080 2.03	4.06 103.1	4.22 107.2	5.81 147.6	5.59 142.0	1218
5218	4.221 107.21	5.598 142.19	4.495 114.17	5.350 135.89	0.125 3.18	0.080 2.03	4.06 103.1	4.22 107.2	5.81 147.6	5.59 142.0	5218
1318	4.489 114.02	6.512 165.40	4.895 124.33	6.148 156.16	0.156 3.96	0.100 2.54	4.26 108.2	4.48 113.8	6.80 172.7	6.51 165.4	1318
7318	4.489 114.02	6.512 165.40	4.895 124.33	6.148 156.16	0.156 3.96	0.100 2.54	4.26 108.2	4.48 113.8	6.80 172.7	6.51 165.4	7318
5318	4.489 114.02	6.512 165.40	4.895 124.33	6.148 156.16	0.156 3.96	0.100 2.54	4.26 108.2	4.48 113.8	6.80 172.7	6.51 165.4	5318
1919	4.115 104.52	4.748 120.60	4.241 107.72	4.622 117.40	0.060 1.52	0.040 1.02	4.02 102.1	4.11 104.4	4.87 123.7	4.74 120.4	1919
1019	4.226 107.34	5.227 132.77	4.425 112.40	5.027 127.69	0.100 2.54	0.060 1.52	4.11 104.4	4.22 107.2	5.38 136.7	5.22 132.6	1019
1219	4.469 113.51	5.954 151.23	4.765 121.03	5.688 144.48	0.125 3.18	0.080 2.03	4.29 109.0	4.46 113.3	6.18 157.0	5.95 151.1	1219
5219	4.469 113.51	5.954 151.23	4.765 121.03	5.688 144.48	0.125 3.18	0.080 2.03	4.29 109.0	4.46 113.3	6.18 157.0	5.95 151.1	5219
1319	4.809 122.15	6.832 173.53	5.215 132.46	6.468 164.29	0.156 3.96	0.100 2.54	4.53 155.1	4.80 121.9	7.16 181.9	6.83 173.5	1319
7319	4.809 122.15	6.832 173.53	5.215 132.46	6.468 164.29	0.156 3.96	0.100 2.54	4.53 155.1	4.80 121.9	7.16 181.9	6.83 173.5	7319
5319	4.809 122.15	6.832 173.53	5.215 132.46	6.468 164.29	0.156 3.96	0.100 2.54	4.53 155.1	4.80 121.9	7.16 181.9	6.83 173.5	5319
1920	4.331 110.01	5.108 129.74	4.485 113.92	4.953 125.81	0.060 1.52	0.040 1.02	4.22 107.2	4.33 110.0	5.25 133.4	5.10 129.5	1920
1020	4.423 112.34	5.424 137.77	4.622 117.40	5.224 132.69	0.100 2.54	0.060 1.52	4.31 109.5	4.42 112.3	5.58 141.7	5.42 137.7	1020
1220	4.764 121.01	6.347 161.21	5.057 128.45	6.070 154.18	0.156 3.96	0.080 2.03	4.57 116.1	4.76 120.9	6.58 167.1	6.34 161.0	1220
5220	4.764 121.01	6.347 161.21	5.057 128.45	6.070 154.18	0.156 3.96	0.080 2.03	4.57 116.1	4.76 120.9	6.58 167.1	6.34 161.0	5220

* The maximum fillet on the shaft or in the housing that the bearing corner will clear.

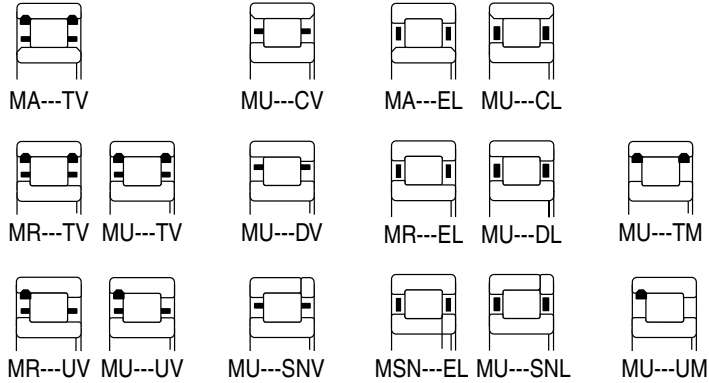
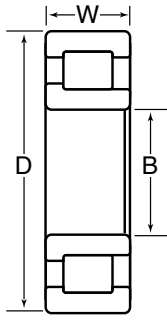

Basic Bearing Number	B		D		W		Radial Load Ratings — lbs./N							
	Bore Diameter	Outside Diameter		Width	One Piece Steel Cage				Composite Steel Cage		X Bar Steel Cage		Full Complement (No Cage)	
		Standard Style	"A" * Style		Outer Ring Assemblies		Inner Ring Assemblies		Dynamic	Static	Dynamic	Static	Dynamic	Static
	Inch/mm				Dynamic	Static	Dynamic	Static	Dynamic	Static	Dynamic	Static	Dynamic	Static
1320	3.9370 100.000	8.4646 215.000	8.4680 215.087	1.8504 47.000					71500 320000	84000 375000			86500 385000	108000 480000
7320	3.9370 100.000	8.4646 215.000	8.4680 215.087	2.3622 60.000					98000 435000	125000 555000				
5320	3.9370 100.000	8.4646 215.000	8.4680 215.087	3.2500 82.550							143000 640000	206000 915000		
1921	4.1339 105.000	5.7087 145.000	5.7113 145.067	0.7874 20.000			17400 77000	25900 115000			18200 81000	27500 122000	20200 89500	31500 140000
1021	4.1339 105.000	6.2992 160.000	6.3020 160.071	1.0236 26.000			30500 135000	43500 193000	30500 135000	43500 193000	31000 139000	45000 201000		
1221	4.1339 105.000	7.4803 190.000	7.4833 190.076	1.4173 36.000	48500 216000	59500 265000	50500 225000	63000 280000					59000 262000	77000 340000
5221	4.1339 105.000	7.4803 190.000	7.4833 190.076	2.5625 65.088	90500 405000	133000 590000								
1321	4.1339 105.000	8.8583 225.000	8.8618 225.090	1.9291 49.000			89500 400000	110000 490000	85000 380000	103000 455000			103000 455000	132000 585000
7321	4.1339 105.000	8.8583 225.000	8.8618 225.090	2.4803 63.000										
5321	4.1339 105.000	8.8583 225.000	8.8618 225.090	3.4375 87.312										
1922	4.3307 110.000	5.9055 150.000	5.9081 150.066	0.7874 20.000			17600 78500	26800 119000	17600 78500	26800 119000	17600 78500	26800 119000		
1022	4.3307 110.000	6.6929 170.000	6.6957 170.071	1.1024 28.000					34500 154000	49000 218000				
1222	4.3307 110.000	7.8740 200.000	7.8771 200.078	1.4961 38.000	54000 240000	68000 305000	54000 240000	68000 305000	52000 230000	64500 287000	56500 250000	72000 320000	63000 280000	83000 370000
7222	4.3307 110.000	7.8740 200.000	7.8771 200.078	1.8110 46.000					68500 305000	92500 410000				
5222	4.3307 110.000	7.8740 200.000	7.8771 200.078	2.7500 69.850					94000 420000	139000 620000	102000 455000	155000 690000		
1322	4.3307 110.000	9.4488 240.000	9.4526 240.096	1.9685 50.000										
7322	4.3307 110.000	9.4488 240.000	9.4526 240.096	2.5591 65.000										
5322	4.3307 110.000	9.4488 240.000	9.4526 240.096	3.6250 92.075										
1924	4.7244 120.000	6.4961 165.000	6.4989 165.072	0.8661 22.000			22000 98000	33500 148000						

* Oversize outer ring for heavy press fit in standard housing bore.

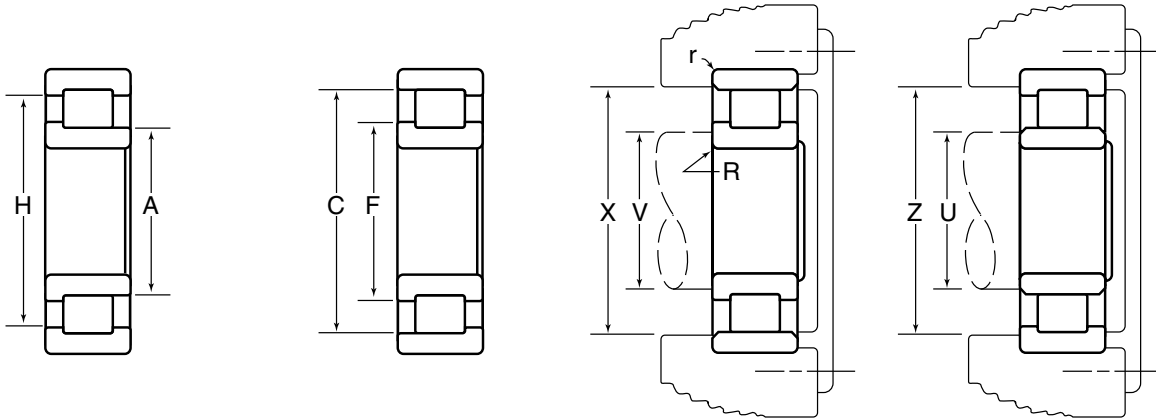

Basic Bearing Number	A	C	F	H	R	r	U	V	X	Z	Basic Bearing Number
	Inner Ring O.D.	Outer Ring I.D.	Inner Ring Rib O.D.	Outer Ring Rib I.D.	Maximum * Fillet Radius		Minimum Shaft Shoulder Diameter		Maximum Housing Shoulder Diameter		
					Shaft	Housing	Plain Rings	Rib Rings	Plain Rings	Rib Rings	
	Inch/mm										
1320	5.125	7.280	5.530	6.892	0.187	0.100	4.82	5.12	7.66	7.28	1320
	130.18	184.91	140.46	175.06	4.75	2.54	122.4	130.0	194.6	184.9	
7320	5.125	7.280	5.530	6.892	0.187	0.100	4.82	5.12	7.66	7.28	7320
	130.18	184.91	140.46	175.06	4.75	2.54	122.4	130.0	194.6	184.9	
5320	5.125	7.280	5.530	6.892	0.187	0.100	4.82	5.12	7.66	7.28	5320
	130.18	184.91	140.46	175.06	4.75	2.54	122.4	130.0	194.6	184.9	
1921	4.527	5.305	4.682	5.150	0.060	0.040	4.41	4.52	5.44	5.30	1921
	114.99	134.75	118.92	130.81	1.52	1.02	112.0	114.8	138.2	134.6	
1021	4.691	5.746	4.901	5.536	0.100	0.080	4.56	4.69	5.91	5.74	1021
	119.15	145.95	124.49	140.61	2.54	2.03	115.8	119.1	150.1	145.8	
1221	4.981	6.636	5.310	6.339	0.156	0.080	4.78	4.98	6.90	6.63	1221
	126.52	168.55	134.87	161.01	3.96	2.03	121.4	126.5	175.3	168.4	
5221	4.981	6.636	5.310	6.339	0.156	0.080	4.78	4.98	6.90	6.63	5221
	126.52	168.55	134.87	161.01	3.96	2.03	121.4	126.5	175.3	168.4	
1321	5.362	7.616	5.794	7.211	0.187	0.100	5.04	5.36	8.01	7.61	1321
	136.19	193.45	147.17	183.16	4.75	2.54	128.0	136.1	203.5	193.3	
7321	5.362	7.616	5.794	7.211	0.187	0.100	5.04	5.36	8.01	7.61	7321
	136.19	193.45	147.17	183.16	4.75	2.54	128.0	136.1	203.5	193.3	
5321	5.362	7.616	5.794	7.211	0.187	0.100	5.04	5.36	8.01	7.61	5321
	136.19	193.45	147.17	183.16	4.75	2.54	128.0	136.1	203.5	193.3	
1922	4.724	5.502	4.879	5.347	0.060	0.040	4.61	4.72	5.64	5.50	1922
	119.99	139.75	123.93	135.81	1.52	1.02	117.1	119.9	143.3	139.7	
1022	4.935	6.092	5.166	5.862	0.100	0.080	4.80	4.93	6.27	6.09	1022
	125.35	154.74	131.22	148.89	2.54	2.03	121.9	125.2	159.3	154.7	
1222	5.234	6.937	5.575	6.631	0.156	0.080	5.01	5.23	7.24	6.93	1222
	132.94	176.20	141.60	168.43	3.96	2.03	127.3	132.8	183.9	176.0	
7222	5.234	6.937	5.575	6.631	0.156	0.080	5.01	5.23	7.24	6.93	7222
	132.94	176.20	141.60	168.43	3.96	2.03	127.3	132.8	183.9	176.0	
5222	5.234	6.937	5.575	6.631	0.156	0.080	5.01	5.23	7.24	6.93	5222
	132.94	176.20	141.60	168.43	3.96	2.03	127.3	132.8	183.9	176.0	
1322	5.719	8.124	6.200	7.692	0.187	0.100	5.35	5.71	8.55	8.12	1322
	145.26	206.35	157.48	195.38	4.75	2.54	135.9	145.0	217.2	206.2	
7322	5.719	8.124	6.200	7.692	0.187	0.100	5.35	5.71	8.55	8.12	7322
	145.26	206.35	157.48	195.38	4.75	2.54	135.9	145.0	217.2	206.2	
5322	5.719	8.124	6.200	7.692	0.187	0.100	5.35	5.71	8.55	8.12	5322
	145.26	206.35	157.48	195.38	4.75	2.54	135.9	145.0	217.2	206.2	
1924	5.177	6.062	5.353	5.886	0.080	0.040	5.11	5.17	6.21	6.06	1924
	131.50	153.97	135.97	149.50	2.03	1.02	129.8	131.3	157.7	153.9	

* The maximum fillet on the shaft or in the housing that the bearing corner will clear.

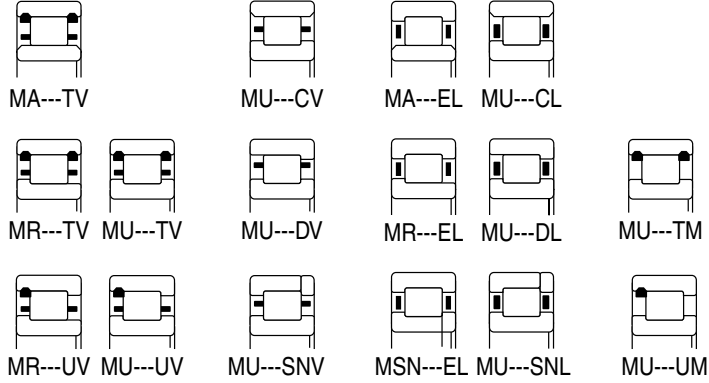
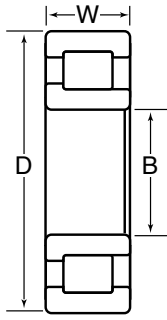

Basic Bearing Number	B		D		W	Radial Load Ratings — lbs./N								
	Bore Diameter	Outside Diameter		Width	One Piece Steel Cage				Composite Steel Cage		X Bar Steel Cage		Full Complement (No Cage)	
		Standard Style	"A" * Style		Outer Ring Assemblies		Inner Ring Assemblies		Dynamic	Static	Dynamic	Static	Dynamic	Static
	Inch/mm					Dynamic	Static	Dynamic	Static	Dynamic	Static	Dynamic	Static	Dynamic
1024	4.7244 120.000	7.0866 180.000	7.0894 180.071	1.1024 28.000			36500 162000	53500 238000			37500 167000	55500 247000		
1224	4.7244 120.000	8.4646 215.000	8.4680 215.087	1.5748 40.000					61000 272000	79000 350000	64000 284000	83500 370000		
5224	4.7244 120.000	8.4646 215.000	8.4680 215.087	3.0000 76.200					128000 570000	204000 905000	133000 595000	215000 955000		
1324	4.7244 120.000	10.2362 260.000	10.2402 260.101	2.1654 55.000										
7324	4.7244 120.000	10.2362 260.000	10.2402 260.101	2.7953 71.000										
5324	4.7244 120.000	10.2362 260.000	10.2402 260.101	4.1250 4.775							214000 950000	305000 1370000		
1926	5.1181 130.000	7.0866 180.000	7.0894 180.071	0.9449 24.000			29400 131000	45500 203000	30000 134000	47000 209000	30000 134000	47000 209000		
1026	5.1181 130.000	7.8740 200.000	7.8771 200.078	1.2992 33.000			46500 207000	66500 296000	46500 207000	66500 296000				
1226	5.1181 130.000	9.0551 230.000	9.0587 230.091	1.5748 40.000					62500 277000	78500 350000	70500 315000	92500 410000		
5226	5.1181 130.000	9.0551 230.000	9.0587 230.091	3.1250 79.375					116000 515000	174000 775000	126000 560000	195000 865000		
1326	5.1181 130.000	11.0236 280.000	11.0276 280.101	2.2835 58.000							124000 555000	154000 685000		
7326	5.1181 130.000	11.0236 280.000	11.0276 280.101	2.9528 75.000										
5326	5.1181 130.000	11.0236 280.000	11.0276 280.101	4.3750 111.125										
1928	5.5118 140.000	7.4803 190.000	7.4833 190.076	0.9449 24.000					31000 138000	50000 222000				
1028	5.5118 140.000	8.2677 210.000	8.2709 210.081	1.2992 33.000										
1228	5.5118 140.000	9.8425 250.000	9.8463 250.096	1.6535 42.000	78000 345000	98500 435000	78000 345000	98500 435000			78000 345000	98500 435000	90500 405000	120000 535000
5228	5.5118 140.000	9.8425 250.000	9.8463 250.096	3.2500 82.550							159000 710000	247000 1100000		
1328	5.5118 140.000	11.8110 300.000	11.8154 300.111	2.4409 62.000										

* Oversize outer ring for heavy press fit in standard housing bore.

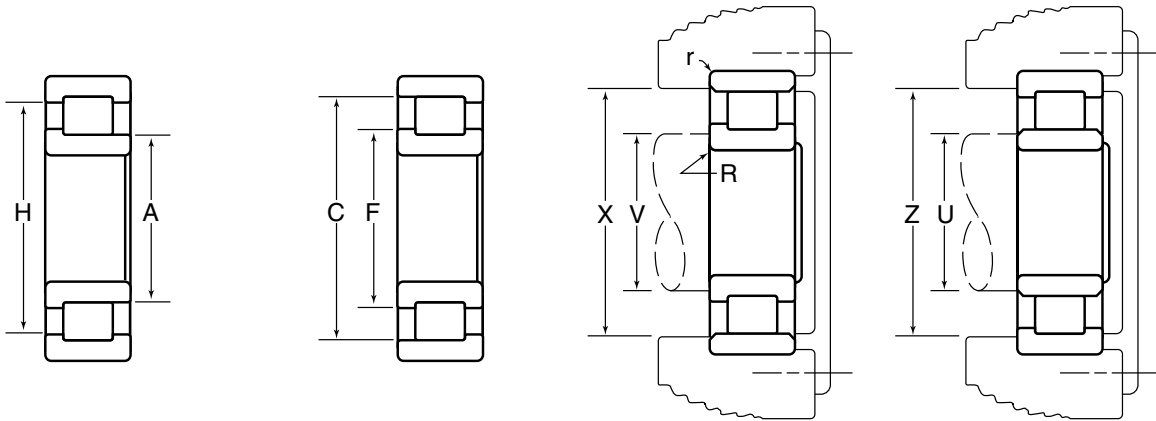

Basic Bearing Number	A	C	F	H	R	r	U	V	X	Z	Basic Bearing Number
	Inner Ring O.D.	Outer Ring I.D.	Inner Ring Rib O.D.	Outer Ring Rib I.D.	Maximum * Fillet Radius		Minimum Shaft Shoulder Diameter		Maximum Housing Shoulder Diameter		
					Shaft	Housing	Plain Rings	Rib Rings	Plain Rings	Rib Rings	
Inch/mm											
1024	5.329	6.486	5.560	6.256	0.125	0.080	5.20	5.32	6.66	6.48	1024
	135.36	164.74	141.22	158.90	3.18	2.03	132.1	135.1	169.2	164.6	
1224	5.714	7.518	6.075	7.194	0.187	0.080	5.48	5.71	7.83	7.51	1224
	145.14	190.96	154.30	182.73	4.75	2.03	139.2	145.0	198.9	190.8	
5224	5.714	7.518	6.075	7.194	0.187	0.080	5.48	5.71	7.83	7.51	5224
	145.14	190.96	154.30	182.73	4.75	2.03	139.2	145.0	198.9	190.8	
1324	6.182	8.782	6.700	8.315	0.250	0.100	5.82	6.18	9.26	8.78	1324
	157.02	223.06	170.18	211.20	6.35	2.54	147.8	157.0	235.2	223.0	
7324	6.182	8.782	6.700	8.315	0.250	0.100	5.82	6.18	9.26	8.78	7324
	157.02	223.06	170.18	211.20	6.35	2.54	147.8	157.0	235.2	223.0	
5324	6.182	8.782	6.700	8.315	0.250	0.100	5.82	6.18	9.26	8.78	5324
	157.02	223.06	170.18	211.20	6.35	2.54	147.8	157.0	235.2	223.0	
1926	5.605	6.607	5.804	6.407	0.080	0.060	5.48	5.60	6.76	6.60	1926
	142.37	167.82	147.42	162.74	2.03	1.52	139.2	142.2	171.7	167.6	
1026	5.810	7.188	6.085	6.913	0.125	0.080	5.63	5.81	7.41	7.18	1026
	147.57	182.58	154.56	175.59	3.18	2.03	143.0	147.6	188.2	182.4	
1226	6.101	8.125	6.485	7.761	0.187	0.100	5.87	6.10	8.42	8.12	1226
	154.97	206.38	164.72	197.13	4.75	2.54	149.1	154.9	213.9	206.2	
5226	6.101	8.125	6.485	7.761	0.187	0.100	5.87	6.10	8.42	8.12	5226
	154.97	206.38	164.72	197.13	4.75	2.54	149.1	154.9	213.9	206.2	
1326	6.714	9.557	7.280	9.046	0.250	0.125	6.31	6.71	10.02	9.55	1326
	170.54	242.75	184.91	229.77	6.35	3.18	160.3	170.4	254.5	242.6	
7326	6.714	9.557	7.280	9.046	0.250	0.125	6.31	6.71	10.02	9.55	7326
	170.54	242.75	184.91	229.77	6.35	3.18	160.3	170.4	254.5	242.6	
5326	6.714	9.557	7.280	9.046	0.250	0.125	6.31	6.71	10.02	9.55	5326
	170.54	242.75	184.91	229.77	6.35	3.18	160.3	170.4	254.5	242.6	
1928	6.001	7.003	6.200	6.803	0.080	0.060	5.87	6.00	7.15	7.00	1928
	152.43	177.88	157.48	172.80	2.03	1.52	149.1	152.4	181.6	177.8	
1028	6.203	7.581	6.478	7.307	0.156	0.080	6.05	6.20	7.80	7.58	1028
	157.56	192.56	164.54	185.60	3.96	2.03	153.7	157.5	198.1	192.5	
1228	6.632	8.835	7.050	8.440	0.187	0.100	6.36	6.63	9.15	8.83	1228
	168.45	224.41	179.07	214.38	4.75	2.54	161.5	168.4	232.4	224.3	
5228	6.632	8.835	7.050	8.440	0.187	0.100	6.36	6.63	9.15	8.83	5228
	168.45	224.41	179.07	214.38	4.75	2.54	161.5	168.4	232.4	224.3	
1328	7.153	10.161	7.755	9.620	0.312	0.125	6.77	7.15	10.68	10.16	1328
	181.69	258.09	196.98	244.35	7.92	3.18	172.0	181.6	271.3	258.1	

* The maximum fillet on the shaft or in the housing that the bearing corner will clear.

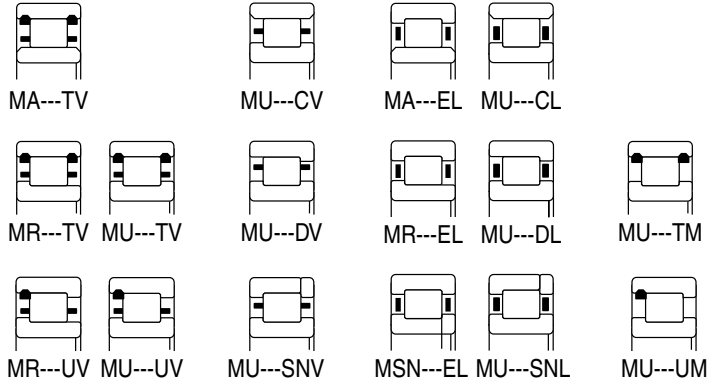
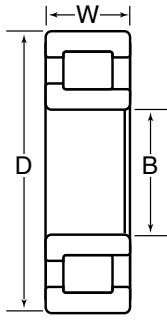

Basic Bearing Number	B		D		W	Radial Load Ratings — lbs./N								
	Bore Diameter	Outside Diameter		Width	One Piece Steel Cage				Composite Steel Cage		X Bar Steel Cage		Full Complement (No Cage)	
		Standard Style	"A" * Style		Outer Ring Assemblies		Inner Ring Assemblies		Dynamic	Static	Dynamic	Static	Dynamic	Static
	Inch/mm				Dynamic	Static	Dynamic	Static						
7328	5.5118	11.8110	11.8154	3.2677										
	140.000	300.000	300.111	83.000										
5328	5.5118	11.8110	11.8154	4.5000										
	140.000	300.000	300.111	114.300										
1930	5.9055	8.2677	8.2709	1.1024					44000	66500	44000	66500		
	150.000	210.000	210.081	28.000					196000	297000	196000	297000		
1030	5.9055	8.8583	8.8618	1.3780					57500	87000				
	150.000	225.000	225.090	35.000					256000	385000				
5030	5.9055	8.8583	8.8618	2.2047							95000	165000		
	150.000	225.000	225.090	56.000							420000	735000		
5230	5.9055	10.6299	10.6339	3.5000							185000	292000		
	150.000	270.000	270.101	88.900							825000	1300000		
1330	5.9055	12.5984	12.6032	2.5591										
	150.000	320.000	320.121	65.000										
7330	5.9055	12.5984	12.6032	3.4252										
	150.000	320.000	320.121	87.000										
5330	5.9055	12.5984	12.6032	4.8750										
	150.000	320.000	320.121	123.825										
1932	6.2992	8.6614	8.6649	1.1024										
	160.000	220.000	220.088	28.000										
1032	6.2992	9.4488	9.4526	1.4961										
	160.000	240.000	240.096	38.000										
1232	6.2992	11.4173	11.4216	1.8898							111000	145000		
	160.000	290.000	290.109	48.000							495000	645000		
5232	6.2992	11.4173	11.4216	3.8750							226000	360000		
	160.000	290.000	290.109	98.425							1010000	1610000		
1332	6.2992	13.3858	13.3906	2.6772										
	160.000	340.000	340.121	68.000										
7332	6.2992	13.3858	13.3906	3.5433										
	160.000	340.000	340.121	90.000										
5332	6.2992	13.3858	13.3906	5.2500										
	160.000	340.000	340.121	133.350										
1934	6.6929	9.0551	9.0587	1.1024			43000	73000			45000	77500		
	170.000	230.000	230.091	28.000			191000	325000			199000	345000		
1034	6.6929	10.2362	10.2402	1.6535										
	170.000	260.000	260.101	42.000										

* Oversize outer ring for heavy press fit in standard housing bore.

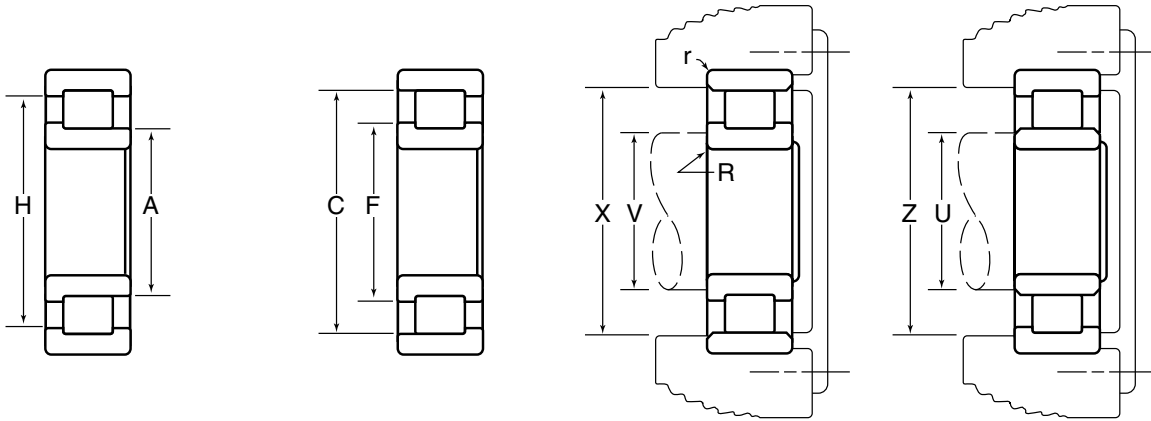

Basic Bearing Number	A	C	F	H	R	r	U	V	X	Z	Basic Bearing Number
	Inner Ring O.D.	Outer Ring I.D.	Inner Ring Rib O.D.	Outer Ring Rib I.D.	Maximum * Fillet Radius		Minimum Shaft Shoulder Diameter		Maximum Housing Shoulder Diameter		
					Shaft	Housing	Plain Rings	Rib Rings	Plain Rings	Rib Rings	
	Inch/mm										
7328	7.153 181.69	10.161 258.09	7.755 196.98	9.620 244.35	0.312 7.92	0.125 3.18	6.77 172.0	7.15 181.6	10.68 271.3	10.16 258.1	7328
5328	7.153 181.69	10.161 258.09	7.755 196.98	9.620 244.35	0.312 7.92	0.125 3.18	6.77 172.0	7.15 181.6	10.68 271.3	10.16 258.1	5328
1930	6.510 165.35	7.669 194.79	6.741 171.22	7.438 188.93	0.125 3.18	0.080 2.03	6.36 161.5	6.51 165.4	7.84 199.1	7.66 194.6	1930
1030	6.641 168.68	8.128 206.45	6.937 176.20	7.832 198.93	0.156 3.96	0.080 2.03	6.47 164.3	6.64 168.7	8.36 212.3	8.12 206.2	1030
5030	6.643 168.73	8.128 206.45	6.937 176.20	7.832 198.93	0.156 3.96	0.080 2.03	6.47 164.3	6.64 168.7	8.36 212.3	8.12 206.2	5030
1230	7.147 181.53	9.522 241.86	7.600 193.04	9.095 231.01	0.250 6.35	0.100 2.54	6.86 174.2	7.14 181.4	9.88 251.0	9.52 241.8	1230
5230	7.147 181.53	9.522 241.86	7.600 193.04	9.095 231.01	0.250 6.35	0.100 2.54	6.86 174.2	7.14 181.4	9.88 251.0	9.52 241.8	5230
1330	7.516 190.91	10.992 279.20	8.210 208.53	10.367 263.32	0.312 7.92	0.125 3.18	7.13 181.1	7.51 190.8	11.50 292.1	10.99 279.1	1330
7330	7.516 190.91	10.992 279.20	8.210 208.53	10.367 263.32	0.312 7.92	0.125 3.18	7.13 181.1	7.51 190.8	11.50 292.1	10.99 279.1	7330
5330	7.516 190.91	10.992 279.20	8.210 208.53	10.367 263.32	0.312 7.92	0.125 3.18	7.13 181.1	7.51 190.8	11.50 292.1	10.99 279.1	5330
1932	6.905 175.39	8.064 204.83	7.136 181.25	7.833 198.96	0.125 3.18	0.080 2.03	6.76 171.7	6.90 175.3	8.24 209.3	8.06 204.7	1932
1032	7.084 179.93	8.669 220.19	7.400 187.96	8.353 212.17	0.156 3.96	0.080 2.03	6.91 175.5	7.08 179.8	8.92 226.6	8.66 220.0	1032
1232	7.623 193.62	10.225 259.72	8.105 205.87	9.757 247.83	0.250 6.35	0.100 2.54	7.31 185.7	7.62 193.5	10.61 269.5	10.22 259.6	1232
5232	7.623 193.62	10.225 259.72	8.105 205.87	9.757 247.83	0.250 6.35	0.100 2.54	7.31 185.7	7.62 193.5	10.61 269.5	10.22 259.6	5232
1332	8.106 205.89	11.582 294.18	8.800 223.52	10.958 278.33	0.375 9.52	0.125 3.18	7.70 195.6	8.10 205.7	12.16 308.9	11.58 294.1	1332
7332	8.106 205.89	11.582 294.18	8.800 223.52	10.958 278.33	0.375 9.52	0.125 3.18	7.70 195.6	8.10 205.7	12.16 308.9	11.58 294.1	7332
5332	8.106 205.89	11.582 294.18	8.800 223.52	10.958 278.33	0.375 9.52	0.125 3.18	7.70 195.6	8.10 205.7	12.16 308.9	11.58 294.1	5332
1934	7.300 185.42	8.459 214.86	7.531 191.29	8.228 208.99	0.125 3.18	0.080 2.03	7.15 181.6	7.30 185.4	8.63 219.2	8.45 214.6	1934
1034	7.615 193.42	9.319 236.70	7.955 202.06	8.980 228.09	0.187 4.75	0.080 2.03	7.41 188.2	7.61 193.3	9.61 244.1	9.31 236.5	1034

* The maximum fillet on the shaft or in the housing that the bearing corner will clear.

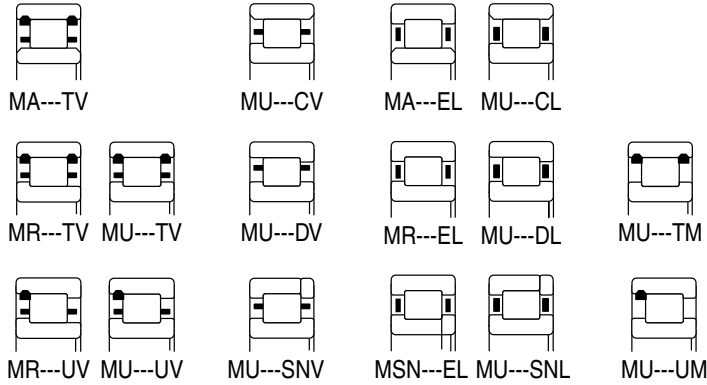
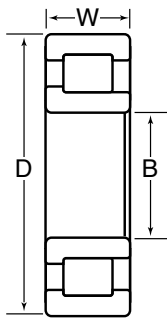

Basic Bearing Number	B		D		W		Radial Load Ratings — lbs./N								
	Bore Diameter	Outside Diameter		Width	One Piece Steel Cage				Composite Steel Cage		X Bar Steel Cage		Full Complement (No Cage)		
		Standard Style	"A" * Style		Outer Ring Assemblies		Inner Ring Assemblies		Dynamic	Static	Dynamic	Static	Dynamic	Static	
	Inch/mm				Dynamic	Static	Dynamic	Static							Dynamic
1234	6.6929 170.000	12.2047 310.000	12.2091 310.111	2.0472 52.000											
5234	6.6929 170.000	12.2047 310.000	12.2091 310.111	4.1250 104.775							260000 1160000	415000 1850000			
1334	6.6929 170.000	14.1732 360.000	14.1781 360.124	2.8346 72.000											
7334	6.6929 170.000	14.1732 360.000	14.1781 360.124	3.7402 95.000											
5334	6.6929 170.000	14.1732 360.000	14.1781 360.124	5.5000 139.700											
1936	7.0866 180.000	9.8425 250.000	9.8463 250.096	1.2992 33.000											
1036	7.0866 180.000	11.0236 280.000	11.0276 280.101	1.8110 46.000					95500 425000	148000 660000					
1236	7.0866 180.000	12.5984 320.000	12.6032 320.121	2.0472 52.000											
5236	7.0866 180.000	12.5984 320.000	12.6032 320.121	4.2500 107.950											
1336	7.0866 180.000	14.9606 380.000	14.9655 380.124	2.9528 75.000											
7336	7.0866 180.000	14.9606 380.000	14.9655 380.124	3.9370 100.000											
5336	7.0866 180.000	14.9606 380.000	14.9655 380.124	5.7500 146.050											
1938	7.4803 190.000	10.2362 260.000	10.2402 260.101	1.2992 33.000											
1038	7.4803 190.000	11.4173 290.000	11.4216 290.109	1.8110 46.000											
1238	7.4803 190.000	13.3858 340.000	13.3906 340.121	2.1654 55.000											
5238	7.4803 190.000	13.3858 340.000	13.3906 340.121	4.5000 114.300											
1338	7.4803 190.000	15.7480 400.000	15.7529 400.124	3.0709 78.000											
7338	7.4803 190.000	15.7480 400.000	15.7529 400.124	4.1339 105.000											

* Oversize outer ring for heavy press fit in standard housing bore.

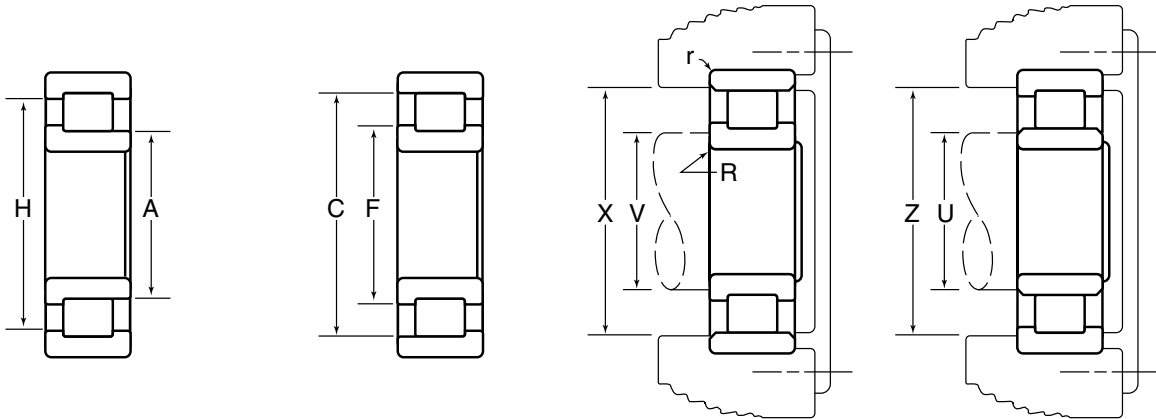

Basic Bearing Number	A	C	F	H	R	r	U	V	X	Z	Basic Bearing Number
	Inner Ring O.D.	Outer Ring I.D.	Inner Ring Rib O.D.	Outer Ring Rib I.D.	Maximum * Fillet Radius		Minimum Shaft Shoulder Diameter		Maximum Housing Shoulder Diameter		
					Shaft	Housing	Plain Rings	Rib Rings	Plain Rings	Rib Rings	
	Inch/mm										
1234	8.090 205.49	10.934 277.72	8.625 219.08	10.423 264.74	0.250 6.35	0.125 3.18	7.76 197.1	8.09 205.5	11.32 287.5	10.93 227.6	1234
5234	8.090 205.49	10.934 277.72	8.625 219.08	10.423 264.74	0.250 6.35	0.125 3.18	7.76 197.1	8.09 205.5	11.32 287.5	10.93 227.6	5234
1334	8.532 216.71	12.338 313.39	9.290 235.97	11.654 296.01	0.375 9.52	0.125 3.18	8.12 206.2	8.53 216.7	12.93 328.4	12.33 313.2	1334
7334	8.532 216.71	12.338 313.39	9.290 235.97	11.654 296.01	0.375 9.52	0.125 3.18	8.12 206.2	8.53 216.7	12.93 328.4	12.33 313.2	7334
5334	8.532 216.71	12.338 313.39	9.290 235.97	11.654 296.01	0.375 9.52	0.125 3.18	8.12 206.2	8.53 216.7	12.93 328.4	12.33 313.2	5334
1936	7.780 197.61	9.159 232.64	8.055 204.60	8.885 225.68	0.156 3.96	0.080 2.03	7.60 193.0	7.78 197.6	9.38 238.3	9.15 232.4	1936
1036	8.094 205.59	10.022 254.56	8.478 215.34	9.638 244.81	0.187 4.75	0.080 2.03	7.86 199.6	8.09 205.5	10.35 262.9	10.02 254.5	1036
1236	8.515 216.28	11.360 288.54	9.050 229.87	10.849 275.56	0.250 6.35	0.125 3.18	8.17 207.5	8.51 216.2	11.74 298.2	11.36 288.5	1236
5236	8.515 216.28	11.360 288.54	9.050 229.87	10.849 275.56	0.250 6.35	0.125 3.18	8.17 207.5	8.51 216.2	11.74 298.2	11.36 288.5	5236
1336	9.123 231.72	12.930 328.42	9.885 251.08	12.246 311.05	0.375 9.52	0.125 3.18	8.63 219.2	9.12 231.6	13.60 345.4	12.93 328.4	1336
7336	9.123 231.72	12.930 328.42	9.885 251.08	12.246 311.05	0.375 9.52	0.125 3.18	8.63 219.2	9.12 231.6	13.60 345.4	12.93 328.4	7336
5336	9.123 231.72	12.930 328.42	9.885 251.08	12.246 311.05	0.375 9.52	0.125 3.18	8.63 219.2	9.12 231.6	13.60 345.4	12.93 328.4	5336
1938	8.178 207.72	9.558 242.77	9.453 214.71	9.283 235.79	0.156 3.96	0.080 2.03	7.99 202.9	8.17 207.5	9.78 248.4	9.55 242.6	1938
1038	8.488 215.60	10.416 264.57	8.872 225.35	10.032 254.81	0.187 4.75	0.080 2.03	8.25 209.6	8.48 215.4	10.74 272.8	10.41 264.4	1038
1238	9.013 228.93	12.023 305.38	9.580 243.33	11.482 291.64	0.312 7.92	0.125 3.18	8.67 220.2	9.01 228.9	12.46 316.5	12.02 305.3	1238
5238	9.013 228.93	12.023 305.38	9.580 243.33	11.482 291.64	0.312 7.92	0.125 3.18	8.67 220.2	9.01 228.9	12.46 316.5	12.02 305.3	5238
1338	9.534 242.16	13.699 347.95	10.365 263.27	12.951 328.96	0.375 9.52	0.156 3.96	9.04 229.6	9.53 242.1	14.07 357.4	13.69 347.7	1338
7338	9.534 242.16	13.699 347.95	10.365 263.27	12.951 328.96	0.375 9.52	0.156 3.96	9.04 229.6	9.53 242.1	14.07 357.4	13.69 347.7	7338

* The maximum fillet on the shaft or in the housing that the bearing corner will clear.

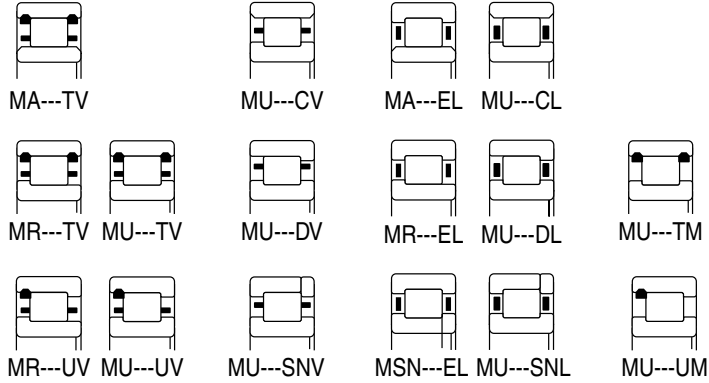
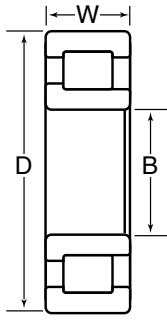

Basic Bearing Number	B		D		W		Radial Load Ratings — lbs./N							
	Bore Diameter	Outside Diameter		Width	One Piece Steel Cage				Composite Steel Cage		X Bar Steel Cage		Full Complement (No Cage)	
		Standard Style	"A" * Style		Outer Ring Assemblies		Inner Ring Assemblies		Dynamic	Static	Dynamic	Static	Dynamic	Static
					Dynamic	Static	Dynamic	Static						
Inch/mm					Dynamic	Static	Dynamic	Static	Dynamic	Static	Dynamic	Static		
5338	7.4803 190.000	15.7480 400.000	15.7529 400.124	6.0000 152.400										
1940	7.8740 200.000	11.0236 280.000	11.0276 280.101	1.4961 38.000										
1040	7.8740 200.000	12.2047 310.000	12.2091 310.111	2.0079 51.000										
1240	7.8740 200.000	14.1732 360.000	14.1781 360.124	2.2835 58.000										
5240	7.8740 200.000	14.1732 360.000	14.1781 360.124	4.7500 120.650										
1340	7.8740 200.000	16.5354 420.000	16.5406 420.131	3.1496 80.000										
7340	7.8740 200.000	16.5354 420.000	16.5406 420.131	4.2913 109.000										
5340	7.8740 200.000	16.5354 420.000	16.5406 420.131	6.5000 165.100										
1944	8.6614 220.000	11.8110 300.000	11.8154 300.111	1.4961 38.000										
1044	8.6614 220.000	13.3858 340.000	13.3906 340.121	2.2047 56.000										
1244	8.6614 220.000	15.7480 400.000	15.7529 400.124	2.5591 65.000										
5244	8.6614 220.000	15.7480 400.000	15.7529 400.124	5.2500 133.350										
1948	9.4488 240.000	12.5984 320.000	12.6032 320.121	1.4961 38.000										
1048	9.4488 240.000	14.1732 360.000	14.1781 360.124	2.2047 56.000						142000 635000	241000 1070000			
1248	9.4488 240.000	17.3228 440.000	17.3280 440.131	2.8346 72.000										
5248	9.4488 240.000	17.3228 440.000	17.3280 440.131	5.7500 146.050										
1952	10.2362 260.000	14.1732 360.000	14.1781 360.124	1.8110 46.000										
1052	10.2362 260.000	15.7480 400.000	15.7529 400.124	2.5591 65.000										

* Oversize outer ring for heavy press fit in standard housing bore.

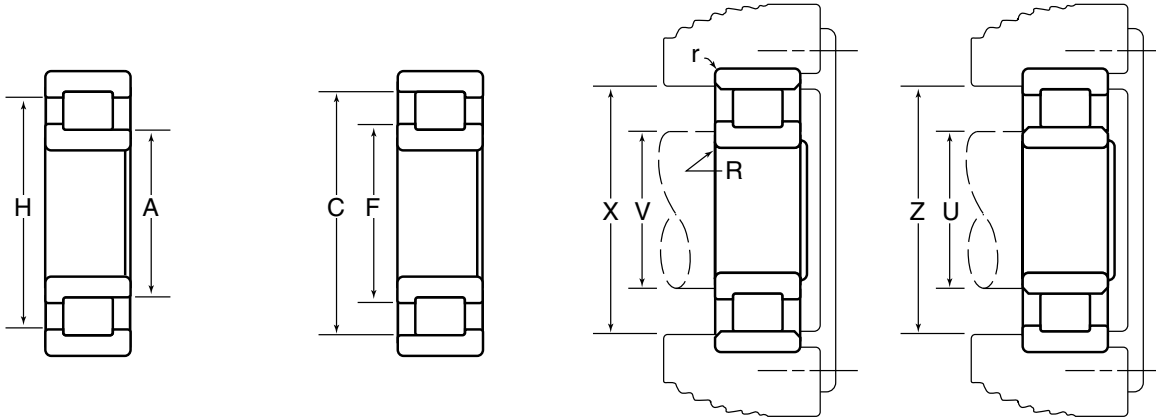

Basic Bearing Number	A	C	F	H	R	r	U	V	X	Z	Basic Bearing Number
	Inner Ring O.D.	Outer Ring I.D.	Inner Ring Rib O.D.	Outer Ring Rib I.D.	Maximum * Fillet Radius		Minimum Shaft Shoulder Diameter		Maximum Housing Shoulder Diameter		
					Shaft	Housing	Plain Rings	Rib Rings	Plain Rings	Rib Rings	
Inch/mm											
5338	9.534 242.16	13.699 347.95	10.365 263.27	12.951 328.96	0.375 9.52	0.156 3.96	9.04 229.6	9.53 242.1	14.07 357.4	13.69 347.7	5338
1940	8.660 219.96	10.246 260.25	8.976 227.99	9.930 252.22	0.187 4.75	0.080 2.03	8.48 215.4	8.66 220.0	10.49 266.4	10.24 260.1	1940
1040	8.964 227.69	11.122 282.50	9.394 238.61	10.692 271.58	0.187 4.75	0.080 2.03	8.70 221.0	8.96 227.6	11.47 291.3	11.12 282.4	1040
1240	9.535 242.19	12.703 322.66	10.135 257.43	12.134 308.20	0.312 7.92	0.125 3.18	9.15 232.4	9.53 242.1	13.17 334.5	12.70 322.6	1240
5240	9.535 242.19	12.703 322.66	10.135 257.43	12.134 308.20	0.312 7.92	0.125 3.18	9.15 232.4	9.53 242.1	13.17 334.5	12.70 322.6	5240
1340	10.125 257.18	14.290 362.97	10.955 278.26	13.542 343.97	0.375 9.52	0.156 3.96	9.57 243.1	10.12 257.0	14.72 373.9	14.29 363.0	1340
7340	10.125 257.18	14.290 362.97	10.955 278.26	13.542 343.97	0.375 9.52	0.156 3.96	9.57 243.1	10.12 257.0	14.72 373.9	14.29 363.0	7340
5340	10.125 257.18	14.290 362.97	10.955 278.26	13.542 343.97	0.375 9.52	0.156 3.96	9.57 243.1	10.12 257.0	14.72 373.9	14.29 363.0	5340
1944	9.450 240.03	11.037 280.34	9.766 248.06	10.721 272.31	0.187 4.75	0.080 2.03	9.27 235.5	9.45 240.0	11.28 286.5	11.03 280.2	1944
1044	9.898 251.41	12.156 308.76	10.348 262.84	11.706 297.33	0.250 6.35	0.100 2.54	9.62 244.3	9.89 251.2	12.55 318.8	12.15 308.6	1044
1244	10.469 265.91	14.138 359.11	11.201 284.51	13.479 342.37	0.375 9.52	0.125 3.18	10.08 256.0	10.46 265.7	14.65 372.1	14.13 358.9	1244
5244	10.469 265.91	14.138 359.11	11.201 284.51	13.479 342.37	0.375 9.52	0.125 3.18	10.08 256.0	10.46 265.7	14.65 372.1	14.13 358.9	5244
1948	10.236 259.99	11.823 300.30	10.552 268.02	11.508 292.30	0.187 4.75	0.080 2.03	10.05 255.3	10.23 259.8	12.07 306.6	11.82 300.2	1948
1048	10.685 271.40	12.944 328.78	11.135 282.83	12.494 317.35	0.250 6.35	0.100 2.54	10.40 264.2	10.68 271.3	13.37 339.6	12.94 328.7	1048
1248	11.464 291.19	15.482 393.24	12.266 311.56	14.760 374.90	0.375 9.52	0.125 3.18	11.00 279.4	11.46 291.1	16.08 408.4	15.48 393.2	1248
5248	11.464 291.19	15.482 393.24	12.266 311.56	14.760 374.90	0.375 9.52	0.125 3.18	11.00 279.4	11.46 291.1	16.08 408.4	15.48 393.2	5248
1952	11.250 285.75	13.180 334.77	11.634 295.50	12.796 325.02	0.281 7.14	0.080 2.03	11.01 279.7	11.25 285.8	13.50 342.9	13.18 334.8	1952
1052	11.651 295.94	14.341 364.26	12.187 309.55	13.806 350.67	0.312 7.92	0.125 3.18	11.35 288.3	11.65 295.9	14.82 376.4	14.34 364.2	1052

* The maximum fillet on the shaft or in the housing that the bearing corner will clear.

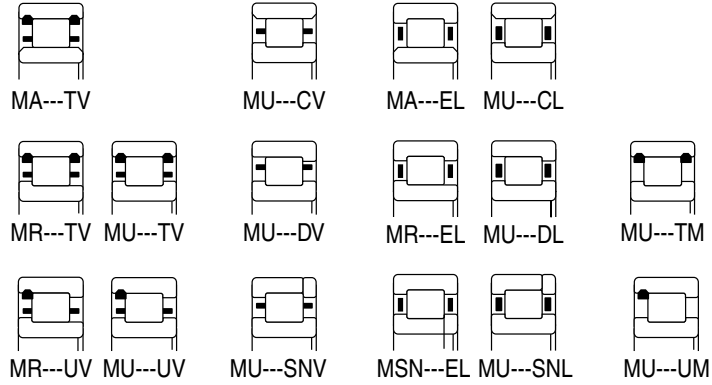
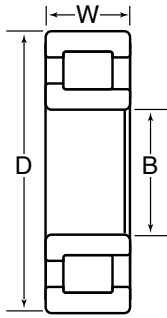

Basic Bearing Number	B	D		W	Radial Load Ratings — lbs./N												
		Bore Diameter	Outside Diameter		One Piece Steel Cage				Composite Steel Cage		X Bar Steel Cage		Full Complement (No Cage)				
	Inch/mm		Standard Style	"A" * Style	Width	Outer Ring Assemblies		Inner Ring Assemblies		Dynamic	Static	Dynamic	Static	Dynamic	Static	Dynamic	Static
		Dynamic				Static	Dynamic	Static									
1252	10.2362 260.000	18.8976 480.000	18.9029 480.134	3.1496 80.000													
5252	10.2362 260.000	18.8976 480.000	18.9029 480.134	6.2500 158.750													
1956	11.0236 280.000	14.9606 380.000	14.9655 380.124	1.8110 46.000			129000 575000	230000 1020000	132000 590000	238000 1060000							
1056	11.0236 280.000	16.5354 420.000	16.5406 420.131	2.5591 65.000													
1256	11.0236 280.000	19.6850 500.000	19.6903 500.134	3.1496 80.000													
5256	11.0236 280.000	19.6850 500.000	19.6903 500.134	6.5000 165.100													
1960	11.8110 300.000	16.5354 420.000	16.5406 420.131	2.2047 56.000													
1964	12.5984 320.000	17.3228 440.000	17.3280 440.131	2.2047 56.000													

* Oversize outer ring for heavy press fit in standard housing bore.

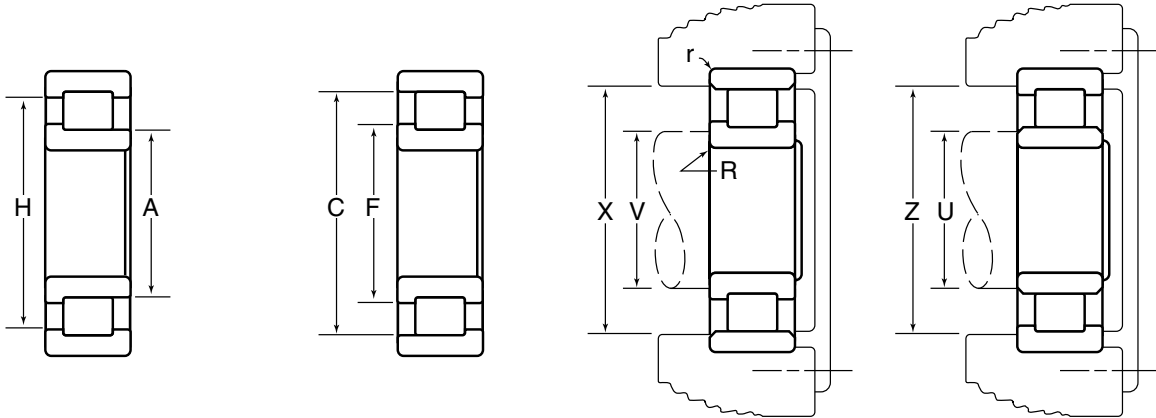

Basic Bearing Number	A	C	F	H	R	r	U	V	X	Z	Basic Bearing Number
	Inner Ring O.D.	Outer Ring I.D.	Inner Ring Rib O.D.	Outer Ring Rib I.D.	Maximum * Fillet Radius		Minimum Shaft Shoulder Diameter		Maximum Housing Shoulder Diameter		
					Shaft	Housing	Plain Rings	Rib Rings	Plain Rings	Rib Rings	
	Inch/mm										
1252	12.543	16.928	13.419	16.140	0.375	0.156	11.97	12.54	17.56	16.92	1252
	318.59	429.97	340.84	409.96	9.52	3.96	304.0	318.5	446.0	429.8	
5252	12.543	16.928	13.419	16.140	0.375	0.156	11.97	12.54	17.56	16.92	5252
	318.59	429.97	340.84	409.96	9.52	3.96	304.0	318.5	446.0	429.8	
1956	12.040	13.970	12.424	13.586	0.281	0.080	11.80	12.04	14.29	13.97	1956
	305.82	354.84	315.57	345.08	7.14	2.03	299.7	305.8	363.0	354.8	
1056	12.438	15.129	12.974	14.593	0.312	0.125	12.14	12.43	15.61	15.12	1056
	315.93	384.28	329.54	370.66	7.92	3.18	308.4	315.7	396.5	384.0	
1256	13.203	17.589	14.079	16.801	0.375	0.156	12.67	13.20	18.26	17.58	1256
	335.36	446.76	357.61	426.75	9.52	3.96	321.8	335.3	463.8	446.5	
5256	13.203	17.589	14.079	16.801	0.375	0.156	12.67	13.20	18.26	17.58	5256
	335.36	446.76	357.61	426.75	9.52	3.96	321.8	335.3	463.8	446.5	
1960	13.050	15.310	13.500	14.861	0.312	0.100	12.77	13.05	15.72	15.31	1960
	331.47	388.87	342.90	377.47	7.92	2.54	324.4	331.5	399.3	388.9	
1964	13.840	16.101	14.290	15.652	0.312	0.100	13.56	13.84	16.51	16.10	1964
	351.54	408.97	362.97	397.56	7.92	2.54	344.4	351.5	419.4	408.9	

* The maximum fillet on the shaft or in the housing that the bearing corner will clear.

**MAX-PAK
(Maximum Capacity)
W60000 Series**

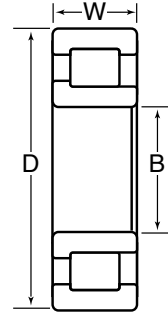

Basic Bearing Number	B		D		W	Radial Load Ratings — lbs./N								
	Bore Diameter	Outside Diameter		Width	One Piece Steel Cage				Composite Steel Cage		X Bar Steel Cage		Full Complement (No Cage)	
		Standard Style	"A" * Style		Outer Ring Assemblies		Inner Ring Assemblies		Dynamic	Static	Dynamic	Static	Dynamic	Static
	Inch/mm				Dynamic	Static	Dynamic	Static						
61007	1.3780 35.000	2.4409 62.000	2.4421 62.029	0.5512 14.000										
61207	1.3780 35.000	2.8346 72.000	2.8359 72.032	0.6693 17.000			11200 50000	11100 49500						
67207	1.3780 35.000	2.8346 72.000	2.8359 72.032	0.7480 19.000										
61307	1.3780 35.000	3.1496 80.000	3.1510 80.035	0.8268 21.000						15600 69500	14800 66000	17500 77500	17300 77000	
67307	1.3780 35.000	3.1496 80.000	3.1510 80.035	1.0236 26.000								22600 100000	24000 107000	
61008	1.5748 40.000	2.6772 68.000	2.6785 68.034	0.5906 15.000										
61208	1.5748 40.000	3.4196 80.000	3.1510 80.035	0.7087 18.000			13000 58000	12900 57000						
67208	1.5748 40.000	3.4196 80.000	3.1510 80.035	0.8268 21.000	15700 70000	16400 73000	15700 70000	16400 73000						
61308	1.5748 40.000	3.5433 90.000	3.5449 90.040	0.9055 23.000			18600 83000	17900 79500				20900 93000	20900 93000	
67308	1.5748 40.000	3.5433 90.000	3.5449 90.040	1.1811 30.000			25400 113000	26800 119000				28500 127000	31000 138000	
61009	1.7717 45.000	2.9528 75.000	2.9542 75.037	0.6299 16.000										
61209	1.7717 45.000	3.3465 85.000	3.3480 85.039	0.7480 19.000			14700 65500	15300 68000		14700 65500	15300 68000			
67209	1.7717 45.000	3.3465 85.000	3.3480 85.039	0.9055 23.000										
61309	1.7717 45.000	3.9370 100.000	3.9388 100.046	0.9843 25.000			23600 105000	23100 103000		23600 105000	23100 103000			
67309	1.7717 45.000	3.9370 100.000	3.9388 100.046	1.2205 31.000										
61010	1.9685 50.000	3.4196 80.000	3.1510 80.035	0.6299 16.000										
61210	1.9685 50.000	3.5433 90.000	3.5449 90.040	0.7874 20.000			16200 72000	17700 78500		16200 72000	17700 78500			
67210	1.9685 50.000	3.5433 90.000	3.5449 90.040	0.9055 23.000			19100 85000	21900 97500		19100 85000	21900 97500			

* Oversize outer ring for heavy press fit in standard housing bore.

**MAX-PAK
(Maximum Capacity)
W60000 Series**

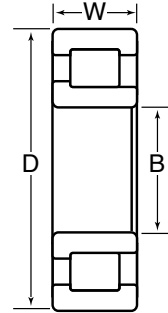

Basic Bearing Number	B	D		W	Radial Load Ratings — lbs./N									
		Outside Diameter			One Piece Steel Cage				Composite Steel Cage		X Bar Steel Cage		Full Complement (No Cage)	
	Bore Diameter	Standard Style	"A" * Style	Width	Outer Ring Assemblies		Inner Ring Assemblies		Dynamic	Static	Dynamic	Static	Dynamic	Static
		Inch/mm			Dynamic	Static	Dynamic	Static						
61310	1.9685 50.000	4.3307 110.000	4.3329 110.056	1.0630 27.000										
67310	1.9685 50.000	4.3307 110.000	4.3329 110.056	1.2992 33.000										
61911	2.1654 55.000	3.4196 80.000	3.1510 80.035	0.5118 13.000										
61011	2.1654 55.000	3.5433 90.000	3.5449 90.040	0.7087 18.000								13900 62000	15900 71000	
61211	2.1654 55.000	3.9370 100.000	3.9388 100.046	0.8268 21.000			19400 86500	21200 94000				13900 62000	15900 71000	
67211	2.1654 55.000	3.9370 100.000	3.9388 100.046	0.9843 25.000	23900 106000	27700 123000	23900 106000	27700 123000				23900 106000	27700 123000	
61311	2.1654 55.000	4.7244 120.000	4.7266 120.056	1.1417 29.000										
67311	2.1654 55.000	4.7244 120.000	4.7266 120.056	1.4173 36.000								42500 189000	47500 212000	
61912	2.3622 60.000	3.3465 85.000	3.3480 85.039	0.5118 13.000										
61012	2.3622 60.000	3.7402 95.000	3.7419 95.044	0.7087 18.000										
61212	2.3622 60.000	4.3307 110.000	4.3329 110.056	0.8661 22.000			22300 99000	24200 107000				22300 99000	24200 107000	
67212	2.3622 60.000	4.3307 110.000	4.3329 110.056	1.0630 27.000	28300 126000	33000 146000	28300 126000	33000 146000				28300 126000	33000 146000	
65212	2.3622 60.000	4.3307 110.000	4.3329 110.056	1.4375 36.512			39000 174000	50000 222000						
61312	2.3622 60.000	5.1181 130.000	5.1204 130.058	1.2205 31.000								37000 164000	37500 167000	
67312	2.3622 60.000	5.1181 130.000	5.1204 130.058	1.4961 38.000								47000 208000	51000 226000	
61913	2.5591 65.000	3.5433 90.000	3.5449 90.040	0.5118 13.000										
61013	2.5591 65.000	3.9370 100.000	3.9388 100.046	0.7087 18.000										
61213	2.5591 65.000	4.7244 120.000	4.7266 120.056	0.9055 23.000			25400 113000	27900 124000	25400 113000	27900 124000		25400 113000	27900 124000	

* Oversize outer ring for heavy press fit in standard housing bore.

**MAX-PAK
(Maximum Capacity)
W60000 Series**

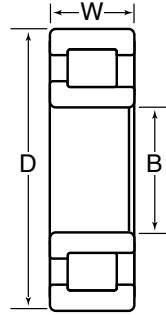

Basic Bearing Number	B		D		W	Radial Load Ratings — lbs./N								
	Bore Diameter	Outside Diameter		Width	One Piece Steel Cage				Composite Steel Cage		X Bar Steel Cage		Full Complement (No Cage)	
		Standard Style	"A" * Style		Outer Ring Assemblies		Inner Ring Assemblies		Dynamic	Static	Dynamic	Static	Dynamic	Static
	Inch/mm				Dynamic	Static	Dynamic	Static	Dynamic	Static	Dynamic	Static	Dynamic	Static
67213	2.5591 65.000	4.7244 120.000	4.7266 120.056	1.1417 29.000	32500 146000	38500 171000	32520 146000	38500 171000			32500 146000	38500 171000		
61313	2.5591 65.000	5.5118 140.000	5.5141 140.058	1.2992 33.000										
67313	2.5591 65.000	5.5118 140.000	5.5141 140.058	1.5748 40.000										
61914	2.7559 70.000	3.9370 100.000	3.9388 100.046	0.6299 16.000							13100 58500	17800 79000		
61014	2.7559 70.000	4.3307 110.000	4.3329 110.056	0.7874 20.000										
61214	2.7559 70.000	4.9213 125.000	4.9236 125.059	0.9449 24.000			28100 125000	32500 144000			28100 125000	32500 144000		
67214	2.7559 70.000	4.9213 125.000	4.9236 125.059	1.2205 31.000										
61314	2.7559 70.000	5.9055 150.000	5.9081 150.066	1.3780 35.000							49500 219000	53000 236000		
67314	2.7559 70.000	5.9055 150.000	5.9081 150.066	1.6929 43.000			62000 275000	71000 315000			62000 275000	71000 315000		
61915	2.9528 75.000	4.1339 105.000	4.1358 105.049	0.6299 16.000			13400 59500	18600 82500						
61015	2.9528 75.000	4.5276 115.000	4.5298 115.057	0.7874 20.000										
61215	2.9528 75.000	5.1181 130.000	5.1204 130.058	0.9843 25.000			31000 137000	35500 158000			31000 137000	35500 158000		
67215	2.9528 75.000	5.1181 130.000	5.1204 130.058	1.2205 31.000	39000 174000	48500 215000	39000 174000	48500 215000			39000 174000	48500 215000		
68215	2.9528 75.000	5.1181 130.000	5.1204 130.058	1.4961 38.000							47000 209000	65000 289000		
61315	2.9528 75.000	6.2992 160.000	6.3020 160.071	1.4567 37.000										
67315	2.9528 75.000	6.2992 160.000	6.3020 160.071	1.8110 46.000	70000 310000	81000 360000	70000 310000	81000 360000			70000 310000	81000 360000		
61916	3.1496 80.000	4.3307 110.000	4.3329 110.056	0.6299 16.000			14000 62500	20100 89000						
61016	3.1496 80.000	4.9213 125.000	4.9236 125.059	0.8661 22.000										

* Oversize outer ring for heavy press fit in standard housing bore.

**MAX-PAK
(Maximum Capacity)
W60000 Series**

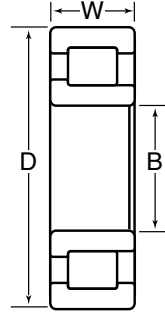

Basic Bearing Number	B		D		W	Radial Load Ratings — lbs./N								
	Bore Diameter	Outside Diameter		Width		One Piece Steel Cage				Composite Steel Cage		X Bar Steel Cage		Full Complement (No Cage)
		Standard Style	"A" * Style		Outer Ring Assemblies	Inner Ring Assemblies	Dynamic	Static	Dynamic	Static	Dynamic	Static	Dynamic	Static
	Inch/mm				Dynamic	Static	Dynamic	Static	Dynamic	Static	Dynamic	Static	Dynamic	Static
61216	3.1496 80.000	5.5118 140.000	5.5141 140.058	1.0236 26.000			33500 150000	40000 178000			33500 150000	40000 178000		
67216	3.1496 80.000	5.5118 140.000	5.5141 140.058	1.2992 33.000			44500 199000	57500 256000			44500 199000	57500 256000		
61316	3.1496 80.000	6.6929 170.000	6.6957 170.071	1.5354 39.000			61000 271000	66500 295000						
67316	3.1496 80.000	6.6929 170.000	6.6957 170.071	1.9291 49.000										
61917	3.3465 85.000	4.7244 120.000	4.7266 120.056	0.7087 18.000										
61017	3.3465 85.000	5.1181 130.000	5.1204 130.058	0.8661 22.000										
61217	3.3465 85.000	5.9055 150.000	5.9081 150.066	1.1024 28.000										
67217	3.3465 85.000	5.9055 150.000	5.9081 150.066	1.3780 35.000	49500 220000	62500 279000	49500 220000	62500 279000			49500 220000	62500 279000		
61317	3.3465 85.000	7.0866 180.000	7.0894 180.071	1.6142 41.000										
67317	3.3465 85.000	7.0866 180.000	7.0894 180.071	2.0079 51.000										
61918	3.5433 90.000	4.9213 125.000	4.9236 125.059	0.7087 18.000			17600 78000	24500 109000	17600 78000	24500 109000	17600 78000	24500 109000		
61018	3.5433 90.000	5.5118 140.000	5.5141 140.058	0.9449 24.000	27800 124000	35000 156000	27800 124000	35000 156000			27800 124000	35000 156000		
61218	3.5433 90.000	6.2992 160.000	6.3020 160.071	1.1811 30.000			44500 199000	51500 228000						
67218	3.5433 90.000	6.2992 160.000	6.3020 160.071	1.4567 37.000	54500 241000	66000 293000	54500 241000	66000 293000			54500 241000	66000 293000		
61318	3.5433 90.000	7.4803 190.000	7.4833 190.076	1.6929 43.000										
67318	3.5433 90.000	7.4803 190.000	7.4833 190.076	2.1260 54.000										
61919	3.7402 95.000	5.1181 130.000	5.1204 130.058	0.7087 18.000			17900 79500	25500 113000						
61019	3.7402 95.000	5.7087 145.000	5.7113 145.067	0.9449 24.000	28700 128000	37000 165000					28700 128000	37000 165000		

* Oversize outer ring for heavy press fit in standard housing bore.

**MAX-PAK
(Maximum Capacity)
W60000 Series**

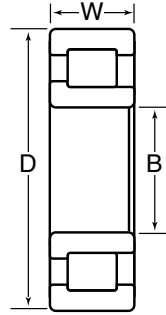

Basic Bearing Number	B		D		W	Radial Load Ratings — lbs./N								
	Bore Diameter	Outside Diameter		Width	One Piece Steel Cage				Composite Steel Cage		X Bar Steel Cage		Full Complement (No Cage)	
		Standard Style	"A" * Style		Outer Ring Assemblies		Inner Ring Assemblies		Dynamic	Static	Dynamic	Static	Dynamic	Static
	Inch/mm				Dynamic	Static	Dynamic	Static						
61219	3.7402 95.000	6.6929 170.000	6.6957 170.071	1.2598 32.000	48000 214000	57500 255000	48000 214000	57500 255000						
67219	3.7402 95.000	6.6929 170.000	6.6957 170.071	1.5354 39.000			61000 271000	78000 345000			61000 271000	78000 345000		
61319	3.7402 95.000	7.8740 200.000	7.8771 200.078	1.7717 45.000										
67319	3.7402 95.000	7.8740 200.000	7.8771 200.078	2.2047 56.000										
61920	3.9370 100.000	5.5118 140.000	5.5141 140.058	0.7874 20.000			22000 98000	31500 139000			22000 98000	31500 139000		
61020	3.9370 100.000	5.9055 150.000	5.9081 150.066	0.9449 24.000										
61220	3.9370 100.000	7.0866 180.000	7.0894 180.071	1.3386 34.000										
67220	3.9370 100.000	7.0866 180.000	7.0894 180.071	1.6142 41.000	69500 310000	86000 385000	69500 310000	86000 385000			69500 310000	86000 385000		
68220	3.9370 100.000	7.0866 180.000	7.0894 180.071	2.0866 53.000							91500 405000	123000 550000		
61320	3.9370 100.000	8.4646 215.000	8.4680 215.087	1.8504 47.000										
67320	3.9370 100.000	8.4646 215.000	8.4680 215.087	2.3622 60.000			121000 535000	144000 640000			121000 535000	144000 640000		
61921	4.1339 105.000	5.7087 145.000	5.7113 145.067	0.7874 20.000										
61021	4.1339 105.000	6.2992 160.000	6.3020 160.071	1.0236 26.000										
61221	4.1339 105.000	7.4803 190.000	7.4833 190.076	1.4173 36.000										
67221	4.1339 105.000	7.4803 190.000	7.4833 190.076	1.6929 43.000			76000 340000	98500 440000			76000 340000	98500 440000		
61321	4.1339 105.000	8.8583 225.000	8.8618 225.090	1.9291 49.000										
67321	4.1339 105.000	8.8583 225.000	8.8618 225.090	2.4803 63.000										
61922	4.3307 110.000	5.9055 150.000	5.9081 150.066	0.7874 20.000									26300 117000	40500 181000

* Oversize outer ring for heavy press fit in standard housing bore.

**MAX-PAK
(Maximum Capacity)
W60000 Series**

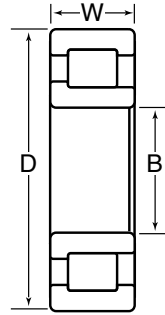

Basic Bearing Number	B		D		W	Radial Load Ratings — lbs./N							
	Bore Diameter	Outside Diameter		Width	One Piece Steel Cage		Composite Steel Cage		X Bar Steel Cage		Full Complement (No Cage)		
		Standard Style	"A" * Style		Outer Ring Assemblies	Inner Ring Assemblies	Dynamic	Static	Dynamic	Static	Dynamic	Static	Dynamic
	Inch/mm					Dynamic	Static	Dynamic	Static	Dynamic	Static	Dynamic	Static
61022	4.3307 110.000	6.6929 170.000	6.6957 170.071	1.1024 28.000									
61222	4.3307 110.000	7.8740 200.000	7.8771 200.078	1.4961 38.000									
67222	4.3307 110.000	7.8740 200.000	7.8771 200.078	1.7717 45.000			83500 370000	105000 465000			83500 370000	105000 465000	
62222	4.3307 110.000	7.8740 200.000	7.8771 200.078	2.0866 53.000							101000 450000	134000 595000	
61322	4.3307 110.000	9.4488 240.000	9.4526 240.096	1.9685 50.000									
67322	4.3307 110.000	9.4488 240.000	9.4526 240.096	2.5591 65.000									
61924	4.7244 120.000	6.4961 165.000	6.4989 165.072	0.8661 22.000									
61024	4.7244 120.000	7.0866 180.000	7.0894 180.071	1.1024 28.000							43000 191000	57500 257000	
61224	4.7244 120.000	8.4646 215.000	8.4680 215.087	1.5748 40.000							75500 335000	93000 415000	
67224	4.7244 120.000	8.4646 215.000	8.4680 215.087	1.8504 47.000									
68224	4.7244 120.000	8.4646 215.000	8.4680 215.087	2.3622 60.000			120000 535000	169000 750000					
61324	4.7244 120.000	10.2362 260.000	10.2402 260.101	2.1654 55.000									
67324	4.7244 120.000	10.2362 260.000	10.2402 260.101	2.7953 71.000									
61926	5.1181 130.000	7.0866 180.000	7.0894 180.071	0.9449 24.000			34000 152000	50500 225000			34000 152000	50500 225000	
61026	5.1181 130.000	7.8470 200.000	7.8771 200.078	1.2992 33.000									
61226	5.1181 130.000	9.0551 230.000	9.0587 230.091	1.5748 40.000									
67226	5.1181 130.000	9.0551 230.000	9.0587 230.091	1.9685 50.000			104000 460000	141000 625000					
61326	5.1181 130.000	11.0236 280.000	11.0276 280.101	2.2835 58.000									

* Oversize outer ring for heavy press fit in standard housing bore.

**MAX-PAK
(Maximum Capacity)
W60000 Series**

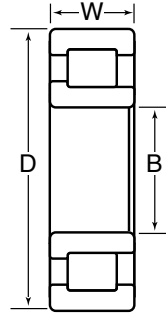

Basic Bearing Number	B		D		W	Radial Load Ratings — lbs./N									
	Bore Diameter	Outside Diameter		Width	One Piece Steel Cage				Composite Steel Cage		X Bar Steel Cage		Full Complement (No Cage)		
		Standard Style	"A" * Style		Outer Ring Assemblies		Inner Ring Assemblies		Dynamic	Static	Dynamic	Static	Dynamic	Static	Dynamic
	Inch/mm				Dynamic	Static	Dynamic	Static	Dynamic	Static	Dynamic	Static	Dynamic	Static	
67326	5.1181 130.000	11.0236 280.000	11.0276 280.101	2.9528 75.000											
61928	5.5118 140.000	7.4803 190.000	7.4833 190.076	0.9449 24.000			34500 154000	52500 233000			34500 154000	52500 233000			
61028	5.5118 140.000	8.2677 210.000	8.2709 210.081	1.2992 33.000											
61228	5.5118 140.000	9.8425 250.000	9.8463 250.096	1.6535 42.000			87500 390000	106000 470000			95500 425000	119000 530000			
67228	5.5118 140.000	9.8425 250.000	9.8463 250.096	2.1654 55.000											
61328	5.5118 140.000	11.8110 300.000	11.8154 300.111	2.4409 62.000											
67328	5.5118 140.000	11.8110 300.000	11.8154 300.111	3.2677 83.000											
61930	5.9055 150.000	8.2677 210.000	8.2709 210.081	1.1024 28.000											
61030	5.9055 150.000	8.8583 225.000	8.8618 225.090	1.3780 35.000											
61230	5.9055 150.000	10.6299 270.000	10.6339 270.101	1.7717 45.000											
67230	5.9055 150.000	10.6299 270.000	10.6339 270.101	2.2835 58.000											
61330	5.9055 150.000	12.5984 320.000	12.6032 320.121	2.5591 65.000											
67330	5.9055 150.000	12.5984 320.000	12.6032 320.121	3.4252 87.000											
61932	6.2992 160.000	8.6614 220.000	8.6649 220.088	1.1024 28.000			49500 221000	75500 335000							
61032	6.2992 160.000	9.4488 240.000	9.4526 240.096	1.4961 38.000			75500 335000	100000 445000							
61232	6.2992 160.000	11.4173 290.000	11.4216 290.109	1.8898 48.000			119000 530000	154000 685000							
67232	6.2992 160.000	11.4173 290.000	11.4216 290.109	2.4409 62.000											
61332	6.2992 160.000	13.3858 340.000	13.3906 340.121	2.6772 68.000											

* Oversize outer ring for heavy press fit in standard housing bore.

**MAX-PAK
(Maximum Capacity)
W60000 Series**

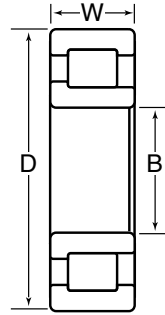

Basic Bearing Number	B		D		W	Radial Load Ratings — lbs./N													
	Bore Diameter	Outside Diameter		Width		One Piece Steel Cage		Composite Steel Cage		X Bar Steel Cage		Full Complement (No Cage)							
		Standard Style	"A" * Style			Outer Ring Assemblies	Inner Ring Assemblies	Dynamic	Static	Dynamic	Static	Dynamic	Static	Dynamic	Static				
	Inch/mm					Dynamic	Static	Dynamic	Static	Dynamic	Static	Dynamic	Static						
67332	6.2992 160.000	13.3858 340.000	13.3906 340.121	3.5433 90.000															
61934	6.6929 170.000	9.0551 230.000	9.0587 230.091	1.1024 28.000															
61034	6.6929 170.000	10.2362 260.000	10.2402 260.101	1.6535 42.000															
61234	6.6929 170.000	12.2047 310.000	12.2091 310.111	2.0472 52.000															
67234	6.6929 170.000	12.2047 310.000	12.2091 310.111	2.4409 62.000															
61334	6.6929 170.000	14.1732 360.000	14.1781 360.124	2.8346 72.000															
67334	6.6929 170.000	14.1732 360.000	14.1781 360.124	3.7402 95.000															
61936	7.0866 180.000	9.8425 250.000	9.8463 250.096	1.2992 33.000			64500 287000	98000 435000											
61036	7.0866 180.000	11.0236 280.000	11.0276 280.101	1.8110 46.000			110000 490000	158000 705000	110000 490000	158000 705000									
61236	7.0866 180.000	12.5984 320.000	12.6032 320.121	2.0472 52.000															
67236	7.0866 180.000	12.5984 320.000	12.6032 320.121	2.5591 65.000															
61336	7.0866 180.000	14.9606 320.000	14.9655 380.124	2.9528 75.000															
67336	7.0866 180.000	14.9606 380.000	14.9655 380.124	3.9370 100.000															
61938	7.4803 190.000	10.2362 260.000	10.2402 260.101	1.2992 33.000			67500 300000	105000 470000	67500 300000	105000 470000									
61038	7.4803 190.000	11.4173 290.000	11.4216 290.109	1.8110 46.000			111000 495000	164000 730000											
61238	7.4803 190.000	13.3858 340.000	13.3906 340.121	2.1654 55.000			160000 710000	207000 925000											
67238	7.4803 190.000	13.3858 340.000	13.3906 340.121	2.6772 68.000															
61338	7.4803 190.000	15.7480 400.000	15.7529 400.124	3.0709 78.000															

* Oversize outer ring for heavy press fit in standard housing bore.

**MAX-PAK
(Maximum Capacity)
W60000 Series**

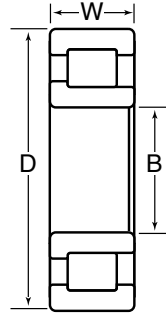

Basic Bearing Number	B		D		W	Radial Load Ratings — lbs./N												
	Bore Diameter	Outside Diameter		Width	One Piece Steel Cage				Composite Steel Cage		X Bar Steel Cage		Full Complement (No Cage)					
		Standard Style	"A" * Style		Outer Ring Assemblies	Inner Ring Assemblies		Dynamic	Static	Dynamic	Static	Dynamic	Static	Dynamic	Static			
	Inch/mm				Dynamic	Static	Dynamic									Static	Dynamic	Static
67338	7.4803 190.000	15.7480 400.000	15.7529 400.124	4.1339 105.000														
61940	7.8740 200.000	11.0236 280.000	11.0276 280.101	1.4961 38.000				83000 370000	130000 580000									
61040	7.8740 200.000	12.2047 310.000	12.2091 310.111	2.0079 51.000				131000 585000	194000 860000	131000 585000	194000 860000							
61240	7.8740 200.000	14.1732 360.000	14.1781 360.124	2.2835 58.000				180000 800000	236000 1050000									
67240	7.8740 200.000	14.1732 360.000	14.1781 360.124	2.8346 72.000														
61340	7.8740 200.000	16.5354 420.000	16.5406 420.131	3.1496 80.000														
67340	7.8740 200.000	16.5354 420.000	16.5406 420.131	4.2913 109.000														
61944	8.6614 220.000	11.8110 300.000	11.8154 300.111	1.4961 38.000				86000 385000	140000 625000									
61044	8.6614 220.000	13.3858 340.000	13.3906 340.121	2.2047 56.000				162000 720000	241000 1070000									
61244	8.6614 220.000	15.7480 400.000	15.7529 400.124	2.5591 65.000														
67244	8.6614 220.000	15.7480 400.000	15.7529 400.124	3.0709 78.000														
61948	9.4488 240.000	12.5984 320.000	12.6032 320.121	1.4961 38.000				89500 395000	151000 670000									
61048	9.4488 240.000	14.1732 360.000	14.1781 360.124	2.2047 56.000														
61248	9.4488 240.000	17.3228 440.000	17.3280 440.131	2.8346 72.000														
67248	9.4488 240.000	17.3228 440.000	17.3280 440.131	3.3465 85.000														
61952	10.2362 260.000	14.1732 360.000	14.1781 360.124	1.8110 46.000				128000 570000	213000 945000									
61052	10.2362 260.000	15.7480 400.000	15.7529 400.124	2.5591 65.000														
61252	10.2362 260.000	18.8976 480.000	18.9029 480.134	3.1496 80.000				330000 1470000	445000 1970000									

* Oversize outer ring for heavy press fit in standard housing bore.

**MAX-PAK
(Maximum Capacity)
W60000 Series**

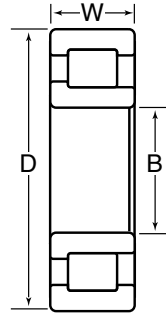

Basic Bearing Number	B		D		W	Radial Load Ratings — lbs./N									
	Bore Diameter	Outside Diameter		Width		One Piece Steel Cage				Composite Steel Cage		X Bar Steel Cage		Full Complement (No Cage)	
		Standard Style	"A" * Style			Outer Ring Assemblies	Inner Ring Assemblies	Dynamic	Static	Dynamic	Static	Dynamic	Static	Dynamic	Static
	Inch/mm					Dynamic	Static								
67252	10.2362	18.8976	18.9029	3.5433											
	260.000	480.000	480.134	90.000											
61956	11.0236	14.9606	14.9655	1.8110											
	280.000	380.000	380.124	46.000											
61056	11.0236	16.5354	16.5406	2.5591											
	280.000	420.000	420.131	65.000											
61256	11.0236	19.6850	19.6903	3.1496											
	280.000	500.000	500.134	80.000											
67256	11.0236	19.6850	19.6903	3.7402											
	280.000	500.000	500.134	95.000											
61960	11.8110	16.5354	16.5406	2.2047											
	300.000	420.000	420.131	56.000											
61964	12.5984	17.3228	17.3280	2.2047							195000	340000			
	320.000	440.000	440.131	56.000							870000	1520000			

* Oversize outer ring for heavy press fit in standard housing bore.

MOJ & MOX Style Cylindrical Roller Bearings

Economical MOJ and MOX roller bearings operate in a very limited space and are easily assembled and disassembled for servicing. The rollers run directly on the hardened and ground surfaces of the shaft and housing, which much have a hardness of Rockwell C58-64 and surface finish no greater than 18 AA to perform at their maximum capacity. Any deviation will result in a reduced load rating which should be discussed with the NTN Application Engineering Department.

MOJ and MOX bearings consist of the same roller complement and composite steel cage components used in the "M" or "W" series bearings.

A part number listing, load ratings, and dimensions are shown on the following pages. For availability and additional information contact NTN sales.

The final drive planetary in this rubber tired earth mover wheel is an ideal application for MOJ or MOX bearings, which must resist shock and carry very heavy radial loads at low speed.



MOJ



MOX

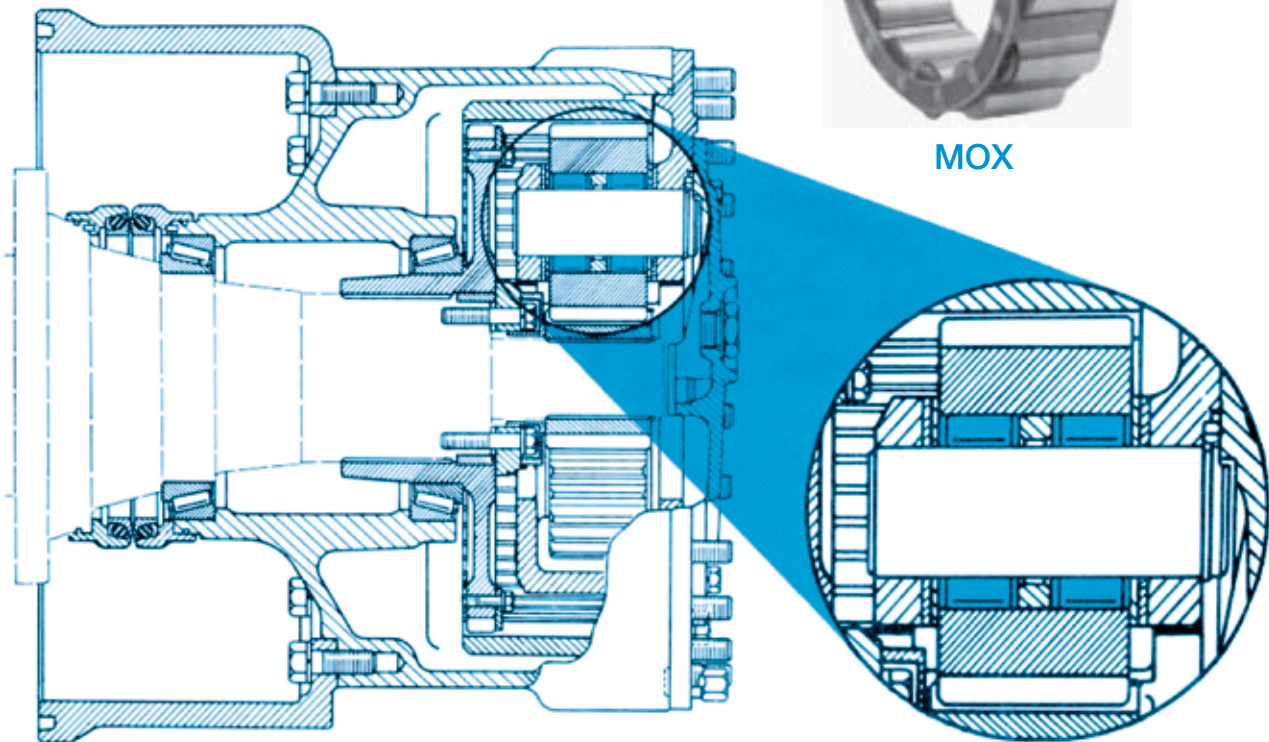

MOJ & MOX Style Bearings Dimensions and Load Ratings

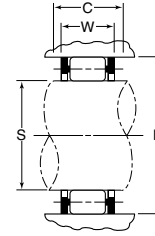

Roller Assembly Number	S	H	C	W	Radial Load Ratings	
	Maximum Shaft Diameter	Minimum Housing Bore	Minimum Operating Spac	Bearing Assembly Width	Dynamic	Static
	Inch/mm				lbs/N	
MOF-1212	2.8511	3.8468	0.891	0.827	18500	20700
	72.418	97.709	22.63	21.01	82500	92000
MOJ-1214	3.3392	4.3893	0.938	0.848	23200	27800
	84.816	11.488	23.83	21.54	103000	124000
MOJ-1316	4.0031	5.8012	1.375	1.315	54000	62000
	101.679	147.350	34.92	33.40	241000	276000
MOX-1318	4.5026	6.5234	1.563	1.457	68500	80000
	114.366	165.694	39.70	37.01	305000	355000
MOJ-5206	1.4994	2.1283	0.875	0.800	12500	14200
	38.085	54.059	22.22	20.32	55500	63000
MOJ-5214	3.3392	4.3893	1.406	1.328	38000	53000
	84.816	111.488	35.71	33.73	170000	235000
MOJ-5216	3.7532	4.9076	1.531	1.463	46500	66000
	95.331	124.653	38.89	37.16	207000	294000
* MOJ-5216-A	3.7532	4.9076	1.531	1.463	46500	66000
	95.331	124.653	38.89	37.16	207000	294000
MOV-5304	1.1013	1.7314	0.925	0.831	9150	8950
	27.973	43.978	23.50	21.11	40500	40000
MOJ-5308	2.0600	3.0557	1.281	1.210	27800	32500
	52.324	77.615	32.54	30.73	124000	145000
MOX-5308-A	2.0600	3.0557	1.250	1.153	26300	30000
	52.324	77.615	31.75	29.29	117000	134000
MOJ-5309	2.3382	3.3883	1.438	1.363	32000	39000
	59.390	86.063	36.52	34.62	143000	173000
MOJ-5310	2.5660	3.7187	1.500	1.441	37500	46000
	65.176	94.455	38.10	36.60	167000	204000
MOJ-5311	2.8136	4.0775	1.656	1.603	49000	62500
	71.465	103.569	42.06	40.72	218000	277000
MOJ-5315	3.7780	5.4773	2.344	2.283	87000	117000
	95.961	139.123	59.54	57.99	390000	520000
MOX-5316-A	4.0031	5.8039	2.266	2.205	90000	119000
	101.679	147.419	57.56	56.01	400000	530000
MOJ-7305	1.3383	2.1034	0.750	0.715	11300	11000
	33.993	53.426	19.05	18.16	50500	49000
MOJ-7309	2.3381	3.3882	1.172	1.129	26300	30000
	59.388	86.060	29.77	28.68	117000	134000
MOJ-7312	3.0545	4.4264	1.406	1.330	42500	50000
	77.584	112.431	35.71	33.78	188000	222000
MOX-7312-N	3.0545	4.4264	1.406	1.330	44500	53500
	77.584	112.431	35.71	33.78	198000	238000
MOX-7312-A	3.0545	4.4264	1.406	1.330	42500	50000
	77.584	112.431	35.71	33.78	188000	222000
MOX-7312-B	3.0545	4.4264	1.406	1.330	42500	50000
	77.584	112.431	35.71	33.78	188000	222000
MOJ-7314	3.5132	5.0911	1.594	1.495	54500	65500
	89.235	129.314	40.49	37.97	242000	291000

* Special crown roller

MOJ & MOX Style Bearings Dimensions and Load Ratings

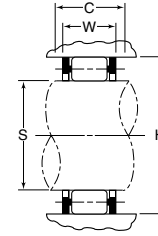

Roller Assembly Number	S	H	C	W	Radial Load Ratings	
	Maximum Shaft Diameter	Minimum Housing Bore	Minimum Operating Spac	Bearing Assembly Width	Dynamic	Static
	Inch/mm				lbs/N	
MOJ-7314-A	3.5132	5.0911	1.594	1.495	54500	65500
	89.235	129.314	40.49	37.97	242000	291000
MOJ-7316	4.0031	5.8039	1.781	1.695	71500	89000
	101.679	147.419	45.24	43.05	320000	395000
MOX-7316-B	4.0031	5.8009	1.781	1.705	70500	87000
	101.679	147.343	45.24	43.31	315000	385000
MOX-7316-C	4.0031	5.8039	1.781	1.720	70500	87000
	101.679	147.419	45.24	43.69	315000	385000
MOX-12876	4.0182	6.3390	2.406	2.330		
	102.062	162.535	61.11	59.18		
WOX-67311	2.7748	4.2333	1.422	1.334	42500	47500
	70.480	107.526	36.12	33.88	189000	212000
WOX-67314	3.4919	5.3200	1.688	1.616	62000	71000
	88.694	135.128	42.88	41.05	275000	315000
WOX-67320	4.9584	7.6298	2.283	2.204	122000	146000
	125.943	193.797	57.99	55.98	540000	650000
J-36-1632	1.1250	1.6255	1.000	0.954	11200	13400
	28.575	41.288	25.40	24.23	50000	59500
J-36-1656	1.1250	1.6255	1.750	1.691	19300	26800
	28.575	41.288	44.45	42.95	86000	119000
J-36-3236	1.1250	2.1255	1.125	1.080	15800	14300
	28.575	53.988	28.58	27.43	70000	63500
JV-44-1419	1.3750	1.8140	0.594	0.548	6100	6950
	34.925	46.076	15.09	13.92	27100	31000
J-68-1630	2.1250	2.6255	0.938	0.883	12500	18000
	53.975	66.688	23.83	22.43	55500	80500
J-78-2039	2.4375	3.0630	1.219	1.176	20700	31000
	61.913	77.800	30.96	29.87	92000	138000
J-92-3246	2.8750	3.8755	1.438	1.373	34500	46500
	73.025	98.438	36.53	34.87	154000	206000
J-104-2430	3.2500	4.0005	0.938	0.890	17200	23400
	82.550	101.613	23.93	22.61	76500	104000
J-104-2442	3.2500	4.0005	1.313	1.243	24900	37500
	82.550	101.613	33.35	31.57	111000	167000
J-108-2034	3.3750	4.0005	1.063	1.006	18100	28500
	85.725	101.613	27.00	25.55	80500	127000
J-114-2039	3.5625	4.1880	1.219	1.176	25300	45000
	90.488	106.375	30.96	29.87	112000	200000
J-120-2026	3.7500	4.3755	0.813	0.762	13500	20300
	95.250	111.138	20.65	19.35	60000	90500
J-124-2442	3.8750	4.6255	1.313	1.248	27100	44500
	98.425	117.488	33.35	31.70	121000	197000
J-128-2446	4.0000	4.7505	1.438	1.377	32000	55500
	101.600	120.663	36.53	34.98	143000	248000
J-132-2030	4.1250	4.7505	0.938	0.881	16900	28000
	104.775	120.663	22.83	22.38	75500	124000

* Special crown roller

Custom "R" Series

In addition to the standard and special cylindrical roller bearings described in previous pages of this catalog, NTN-Bower also manufactures a customized line of precision non-standard cylindrical roller bearings. This line of bearings was custom designed and manufactured to a customer requirement, or was recommended by NTN-Bower to improve the performance of an existing application.

Listed below and on the following pages is a part number listing and contains the basic bearing dimensions, and radial and static load ratings.

Since this product line is of a customized nature and contains many different bearing configurations, cage styles, etc., contact NTN Sales for additions information and part number availability.

Typical applications for this product line include:

- Automotive Rear Wheels
- Automotive and Truck Pinion Pilot
- Industrial Clutch Pilot Support
- Steel Mill Ingot Car Wheels
- Steel Mill Conveyor Wheels

Complete Bearing Number	Basic Bearing Dimensions			Roller Assembly Number	Basic Bearing Dimensions			Radial Load Ratings	
	Inside Diameter	Outside Diameter	Width		Inside Diameter	Outside Diameter	Width	Dynamic	Static
	Inch/mm				Inch/mm			lbs/N	
R-1500-EL	—	—	—	R-1500-EL	1.5800 40.132	2.4062 61.117	0.7500 19.050	10000 44500	12600 56000
RA-1502-EL	1.5308 38.882	2.7818 70.658	1.3440 34.138	R-1502-EL	1.8722 47.681	2.7818 70.658	0.8750 22.225	12200 54000	15800 70500
R-1506-EL	—	—	—	R-1506-EL	1.8287 46.449	3.1250 79.375	0.7480 19.000	11500 51500	11300 50000
R-1518-EL	—	—	—	R-1518-EL	0.8109 20.597	1.6535 41.999	0.5118 13.000	4250 18800	3400 15100
RR-1522-EHL	3.9370 100.000	8.4646 215.001	2.0472 51.999	R-1522-EHL	5.1323 130.360	8.4646 215.001	2.0472 51.999	87000 385000	108000 480000
RU-1523-CHV	7.8740 200.000	12.2047 310.000	2.0472 51.999	RU-1523-V	7.8740 200.000	11.0487 280.637	2.0079 51.001	123000 550000	206000 915000
RUB-1523-DV	8.2500 209.550	12.2047 310.000	2.0079 51.001	RUB-1523-V	8.2500 209.550	11.0487 280.637	2.0079 51.001	123000 550000	206000 915000
RA-1530-EL	3.1496 80.000	6.6929 170.000	1.7500 44.450	R-1530-EL	4.0041 101.704	6.6929 170.000	1.7500 44.450	64000 285000	77000 345000
RR-1530-EL	3.1496 80.000	6.6929 170.000	1.7500 44.450	R-1530-EL	4.0041 101.704	6.6929 170.000	1.7500 44.450	64000 285000	77000 345000
R-1535-TAV	—	—	—	R-1535-TAV	1.1092 28.174	1.8505 47.000	0.6560 16.662	6450 28700	6550 29100
RU-1540-CAL	3.9370 100.000	7.0894 180.071	1.4567 37.000	RU-1540-L	3.9370 100.000	6.3436 161.127	1.4567 37.000	54500 243000	71000 315000
RSN-1542-EBL	1.3776 34.991	3.0000 76.200	1.4687 37.306	—	—	—	—	9550 42500	9550 42500
RU-1545-SAXL	2.3622 59.995	5.1204 130.058	1.3125 33.338	RU-1545-L	2.3622 60.000	4.4264 112.431	1.3125 33.338	37500 167000	43000 192000
RU-1547-CAHL	3.5433 90.000	7.4833 190.076	1.8504 47.000	RU-1547-L	3.5433 90.000	6.5088 165.324	1.8504 47.000	72500 325000	86500 385000
RU-1547-DAHL	3.5433 90.000	7.4833 190.076	1.8504 47.000	RU-1547-L	3.5433 90.000	6.5088 165.324	1.8504 47.000	72500 325000	86500 385000
RU-1547-DHEL	3.5433 90.000	7.4833 190.076	1.8504 47.000	RU-1547-L	3.5433 90.000	6.5088 165.324	1.8504 47.000	72500 325000	86500 385000
RU-1549-L	—	—	—	RU-1549-L	1.1806 29.987	2.4397 61.968	0.6299 16.000	9050 40500	8850 39500
RU-1557-J	—	—	—	RU-1557-J	1.1806 29.987	2.4397 61.968	0.7500 19.050	12400 55000	12200 54000

“R” Series Dimensions and Load Ratings

Complete Bearing Number	Basic Bearing Dimensions			Roller Assembly Number	Basic Bearing Dimensions			Radial Load Ratings	
	Inside Diameter	Outside Diameter	Width		Inside Diameter	Outside Diameter	Width	Dynamic	Static
	Inch/mm				Inch/mm			lbs/N	
R-1558-TAV	—	—	—	R-1558-TAV	0.7515 19.088	1.2508 31.770	0.6050 15.367	3850 17100	3900 17200
R-1559-TAV	—	—	—	R-1559-TAV	1.6201 41.151	2.5312 64.292	0.8300 21.082	12700 56500	14800 65500
R-1559-TDV	—	—	—	R-1559-TDV	1.6210 41.173	2.5312 64.292	0.8300 21.082	12700 56500	14800 65500
RA-1562-EBL	1.1807 29.990	2.8356 72.024	1.1875 30.163	—	—	—	—	11100 49500	10800 48000
R-1563-TKV	—	—	—	R-1563-TKV	1.4008 35.580	2.2500 57.150	0.7000 17.780	8600 38500	9300 41500
RA-1567-EBF	1.3775 34.989	3.1506 80.025	1.3750 34.925	—	—	—	—	14000 62000	14300 63500
RA-1567-EBL	1.3775 34.989	3.1506 80.025	1.3750 34.925	—	—	—	—	14000 62000	14300 63500
RU-1570-UM	1.3776 34.991	2.8346 71.999	0.8130 20.650	—	—	—	—	14800 66000	16200 72000
RU-1570-UBM	1.3776 34.991	2.8646 72.761	0.8130 20.650	—	—	—	—	14800 66000	16200 72000
RUB-1570-UM	1.1811 30.000	2.8346 71.999	0.8130 20.650	—	—	—	—	14800 66000	16200 72000
RA-1572-EBL	1.7712 44.988	3.9384 100.035	1.5625 39.688	—	—	—	—	21800 97000	23600 105000
RSB-1578-EF	1.3780 35.001	2.5590 64.999	1.3700 34.798	—	—	—	—	8900 39500	9400 42000
RSB-1579-EF	1.5630 39.700	2.8760 73.050	1.3180 33.477	—	—	—	—	11200 50000	11700 52000
RSB-1579-EBF	1.5630 39.700	3.1493 79.992	1.3810 35.077	—	—	—	—	11200 50000	11700 52000
RSD-1579-EF	1.5630 39.700	2.8760 73.050	1.3810 33.477	—	—	—	—	11200 50000	11700 52000
RUB-1580-EBF	1.6248 41.275	3.1496 80.000	1.0830 27.508	—	—	—	—	10100 45000	9350 41500
RUB-1580-ECF	1.6248 41.275	3.1496 80.000	1.0830 27.508	—	—	—	—	10100 45000	9350 41500
R-1581-TV	1.2639 32.103	2.0472 51.999	0.7650 19.431	R-1581-TV	—	—	—	9300 41500	9950 44500
RSD-1584-EV	1.7717 45.001	3.1496 80.000	1.5294 38.847	—	—	—	—	14100 63000	15800 70000
RSN-1584-EF	1.7717 45.001	3.1496 80.000	1.5294 38.847	—	—	—	—	14100 63000	15800 70000
R-1722-TV	—	—	—	R-1722-TV	1.4026 35.626	2.2500 57.150	0.7000 17.780	8600 38500	9300 41500
RS-1930-EJ	5.9055 150.000	8.2677 210.000	1.1024 28.000	R-1930-EJ	5.9055 150.000	8.2677 210.000	1.1024 28.000	36500 163000	56500 251000
TW-2319	3.5635 90.513	10.0100 254.254	4.0100 101.854	—	—	—	—	111000 490000	151000 670000
TW-5216	2.7510 69.875	7.0100 178.054	3.1350 79.629	—	—	—	—	52500 235000	77500 345000

“R” Series Dimensions and Load Ratings

Complete Bearing Number	Basic Bearing Dimensions			Roller Assembly Number	Basic Bearing Dimensions			Radial Load Ratings	
	Inside Diameter	Outside Diameter	Width		Inside Diameter	Outside Diameter	Width	Dynamic	Static
	Inch/mm				Inch/mm			lbs/N	
TW-5217	3.2508 82.570	7.0100 178.054	3.1350 76.629	—	—	—	—	55000 244000	78500 350000
TWB-5217	3.2508 82.570	7.0100 178.054	3.1350 76.629	—	—	—	—	55000 244000	78500 350000
TWC-5217	3.2508 82.570	7.0100 178.054	3.1350 76.629	—	—	—	—	55000 244000	75800 350000
TW-5218	3.5010 88.925	7.0100 178.054	3.4375 84.313	—	—	—	—	65000 290000	94000 420000
RS-5305-W	1.2506 31.765	2.4419 62.024	1.0620 26.925	RS-5305-W	—	—	—	14900 66500	14900 66500
RBS-5305-W	0.9843 25.001	2.4419 62.024	1.0620 26.975	RBS-5305-W	—	—	—	14900 66500	14900 66500
TW-5309	1.7510 44.475	5.0100 127.254	2.8220 71.679	—	—	—	—	33500 148000	40500 181000
R-5707-EV	—	—	—	R-5707-EV	1.4018 35.606	2.2519 57.198	0.7050 17.907	9750 43500	9650 43000
R-5806-DF	—	—	—	R-5806-DF	1.1838 30.069	2.2835 58.001	0.8540 21.692	12200 54000	12100 54000
R-6207-CF	—	—	—	R-6207-CF	1.3780 35.000	2.4409 61.999	0.6693 17.000	7300 32500	6550 29100
R-6208-TBM	—	—	—	R-6208-TBM	1.5008 38.120	2.4409 61.999	1.4700 37.338	15100 67000	21200 94500
R-6208-TKM	—	—	—	R-6208-TKM	1.5008 38.120	2.007 61.999	1.4700 37.338	15100 67000	21200 94500
R-6208-TM	—	—	—	R-6208-TM	1.5008 38.120	2.4409 61.999	1.4700 37.338	15100 67000	21200 94500
R-6408-EV	—	—	—	R-6408-EV	1.6203 41.156	2.5304 64.272	0.8300 21.082	13300 59000	14000 62500
RU-6805-UM	1.0930 27.762	2.6772 68.000	0.7480 19.000	—	—	—	—	14200 63000	15100 67000
RU-6806-UM	1.0930 27.762	2.6772 68.000	0.7480 19.000	—	—	—	—	12300 55000	12600 56000
RU-8509-TM	1.7500 44.450	3.3465 85.001	1.1250 28.575	RU-8509-TM	—	—	—	14600 65000	17000 76000
RU-9008UM	1.5748 40.000	3.5433 90.000	0.9843 25.001	RU-9008UM	—	—	—	23000 102000	23500 104000
RU-9008UBM	1.5748 40.000	3.6224 92.009	0.9843 25.001	RU-9008UBM	—	—	—	23000 102000	23500 104000
RU-9808-UCM	1.5748 39.400	3.5433 89.000	0.9843 25.001	—	—	—	—	23000 102000	23500 104000
R-10012-GEXR	2.3030 58.496	3.3970 86.284	0.9843 25.001	R-10012-GEXR	—	—	—	22200 98500	23800 106000
R-16828-EX	—	—	—	R-16828-EX	5.5020 139.751	6.6250 168.275	1.0630 27.000	29300 131000	56500 252000
RAB-61539-EV	3.6120 91.745	6.6941 170.030	1.6562 42.067	R-61539-EV	4.3190 109.703	6.6941 170.030	1.5354 38.999	58500 260000	71500 320000
RU-61565-DV	7.0010 177.825	11.3750 288.925	2.8125 71.438	RU-61565-V	7.0010 177.825	10.4614 265.720	2.8125 71.438	163000 725000	255000 1140000
RU-61568-DV	8.2510 209.575	12.5000 317.500	2.8125 71.438	RU-61568-V	8.2510 209.575	11.6184 295.107	2.8125 71.438	172000 765000	284000 1260000

Mast and Chain Guide Bearings

Fork lift trucks are employed in almost every manufacturing and shipping facility where lifting or movement of materials is required. An essential part of a fork lift truck is the channeled lift structure which is commonly called the mast. Roller bearings are a basic part of the mast as they guide and retain the forks in the vertical channels. Chain sheave roller bearings which guide the chain and facilitate the lifting and lowering of the mast are an important part of the entire upright system.

Fork lift trucks handle loads ranging from light, bulky material to heavy loads in excess of 4,000 pounds. Mast guide bearings are specifically designed to withstand the heavy impact and radial loads required in this type of application. Mast or chain guide bearings have heavy section outer rings which serve as rollers, or guides for the carriage in the mast channels. The configuration of the outer ring is designed to fit the contour of the mast channel or chain.

In conjunction with the heavy radial loads experienced, thrust loading is also present, which tends to cause misalignment. The internal construction of NTN-Bower cylindrical roller bearings resists misalignment of the outer ring. All mast guide and chain sheave roller bearings are sealed and factory lubricated with a water resistant grease to prevent contamination of the rolling elements and raceways.

NTN-Bower cylindrical roller bearings for mast and chain guide applications are manufactured for leading fork lift truck manufacturers. They are basic full roller complement (no cage) 1200 and 1300 series bearings of single row construction.

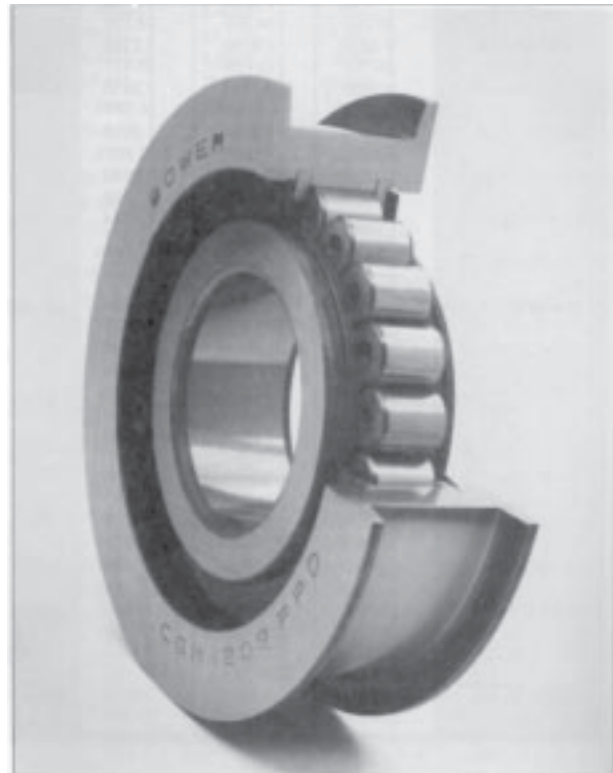
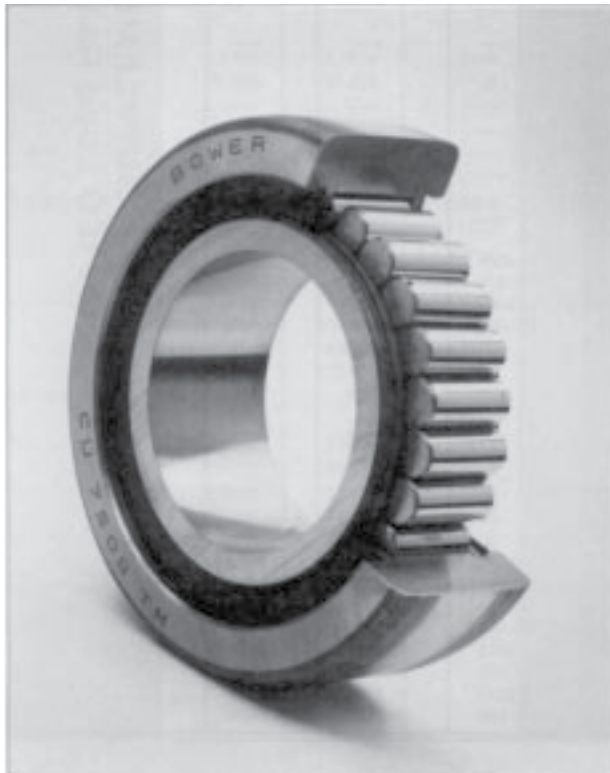

Mast and Chain Guide Bearings Dimensions and Load Ratings

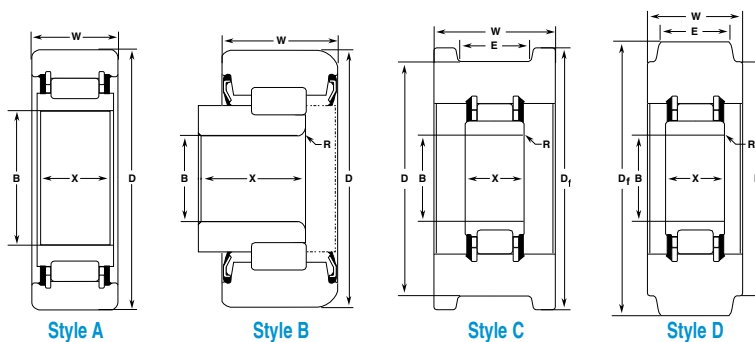

Bearing Number	Style	B	D	X	W	R	E	D _f	Radial Load Ratings	
		Inside Diameter	Outside Diameter	Race Width		Break	Sheave		Dynamic	Static
		Inch/mm								lbs/N
▲ CGM-1209-PPA	C	1.5748 40.000	3.755 95.38	0.905 22.99	1.307 33.20	.070 R 1.78	0.995 25.27	4.250 107.95	14200 63000	16100 71500
CGM-1209-PPB	C	1.5748 40.000	3.740 95.00	1.140 28.96	1.025 26.04	.070 R 1.78	0.730 18.54	4.252 108.00	14200 63000	16100 71500
■ CGM-1209-PPC	C	1.5748 40.000	3.230 82.04	1.005 25.53	1.025 26.04	.070 R 1.78	0.730 18.54	3.740 95.00	14200 63000	16100 71500
▲ CGM-1209-PPD	C	1.5748 40.000	3.505 89.03	0.905 22.99	1.125 28.58	.070 R 1.78	0.870 22.10	4.000 101.60	14200 63000	16100 71500
▲ CGM-1209-PPE	C	1.5748 40.000	3.755 95.38	0.905 22.99	1.347 34.21	0.07R 1.78	1.065 27.05	4.125 104.77	14200 63000	16100 71500
CGM-5207-PPA	C	1.3780 35.000	3.583 91.00	1.187 30.15	1.949 49.50	.118x45°C 3.00	1.646 41.81	4.055 103.00	17800 79500	21400 95500
CGM-5207-PPB	C	1.3780 35.000	3.583 91.00	1.187 30.15	1.949 49.50	.118x45°C 3.00	1.394 35.41	4.055 103.0	17800 79500	21400 95500
CGM-5214-PPB	C	1.7717 45.000	5.040 128.00	2.000 50.80	2.717 69.00	.394 R 10.00	1.968 50.00	5.920 150.37	39000 172000	50500 225000
CGM-5214-PPD	C	1.7717 45.000	5.906 150.00	2.000 50.80	2.835 72.00	0.394R 10.00	1.968 50.00	6.890 175.00	39000 172000	50500 225000
CGM-5216-PPA	C	1.9685 50.000	5.000 127.00	1.574 39.98	2.087 53.00	.110 R 2.79	1.417 36.00	5.906 150.00	43500 193000	55500 248000
■ CS-5704-EM	B	0.7500 19.050	2.250 57.15	0.963 24.46	0.995 25.27	.070 R 1.78	— —	— —	9000 40000	10100 45000
● CU-7508-TM	A	1.5739 39.977	2.295 75.57	0.875 22.23	1.000 25.40	.015x45°C 0.38	— —	— —	13300 59000	18900 84000
CU-8907-TM	C	1.3780 35.000	3.500 88.90	1.062 26.97	1.625 41.28	.040 R 1.02	1.280 32.51	4.000 101.60	19100 85000	21000 93500
CGM-9509-PPA	C	1.7500 44.450	3.723 94.56	1.573 39.95	1.750 44.45	0.070 1.78	1.373 34.87	4.375 111.13	28600 127000	34500 154000
CU-10009-UV	A	1.7712 44.988	3.937 100.00	1.563 39.70	1.563 39.70	0.110R 2.79	— —	— —	26300 117000	30000 134000
CU-10308TM	D	1.5748 39.100	4.055 102.10	0.906 23.01	0.906 23.01	0.090 2.29	0.575 14.61	3.493 88.72	16000 71000	18000 80000
CU-10807-TM	C	1.3780 35.000	4.250 107.95	1.062 26.97	1.625 41.28	.040 R 1.02	1.280 32.51	4.750 120.65	19100 85000	21000 93500
CU-15010-TM	A	1.9685 49.100	5.905 149.99	1.575 40.01	2.087 53.01	0.110 2.79	— —	— —	43500 193000	55500 248000

- ▲ Two 1/8 inch diameter holes in inner ring, 180° apart.
- Inner ring not central to outer ring.
- Spherical O.D.
- ◆ Dynamic radial load ratings are based on 500 hrs. L10 Life @ 33 1/3 rpm.

ABMA/ANSI Dimensional Tolerances Inner Ring

Basic Bore Diameter		Bore Diameter Tolerances*					Radial Runout	Width Limits	
		B Mean		Out of Roundness					
				Diameter Series					
				900	000	200 300			
Inch/mm		.0001 Inch/Micrometres							
Over	Incl.	High	Low	Max.	Max.	Max.	Max.	High	Low
0.7087 18.000	1.1811 30.000	+ 0 + 0	-4 -10	5 13	4 10	3 8	5 13	+ 0 + 0	-47 -120
1.1811 30.000	1.9685 50.000	+ 0 + 0	-4.5 -12	6 15	4.5 12	3.5 9	6 15	+ 0 + 0	-47 -120
1.9685 50.000	3.1496 80.000	+ 0 + 0	-6 -15	7.5 19	7.5 19	4.5 11	8 20	+ 0 + 0	-59 -150
3.1496 80.000	4.7244 120.000	+ 0 + 0	-8 -20	10 25	10 25	6 15	10 25	+ 0 + 0	-79 -200
4.7244 120.000	7.0866 180.000	+ 0 + 0	-10 -25	12 31	12 31	7.5 19	12 30	+ 0 + 0	-98 -250
7.0866 180.000	9.8425 250.000	+ 0 + 0	-12 -30	15 38	15 38	9 23	16 40	+ 0 + 0	-118 -300
9.8425 250.000	12.4015 315.000	+ 0 + 0	-14 -35	17 44	17 44	10 26	20 50	+ 0 + 0	-138 -350
12.4015 315.000	15.7480 400.000	+ 0 + 0	-16 -40	20 50	20 50	12 30	24 60	+ 0 + 0	-157 -400

* B Mean represents the Mean Bore Diameter Tolerance.
Out of Roundness represents the Maximum Bore Diameter Variation in a single radial plane.

Outer Ring

Basic Outside Diameter		Outside Diameter Tolerances**					Radial Runout	Width Limits	
		D Mean		Out of Roundness					
				Open Bearing		Bearing With Internal Snap Rings			
				Diameter Series					
900	000	200/300	200/300						
Inch/mm		.0001 Inch/Micrometres							
Over	Incl.	High	Low	Max.	Max.	Max.	Max.	Max.	High/Low
1.1811 30.000	1.9685 50.000	+0 +0	-4.5 -11	5.5 14	4.5 11	3 8	6.5 16	8 20	Same as Inner Ring of the Same Bearing
1.9685 50.000	3.1496 80.000	+0 +0	-5 -13	6.5 16	5 13	4 10	8 20	10 25	
3.1496 80.000	4.7244 120.000	+0 +0	-6 -15	7.5 19	7.5 19	4.5 11	10 26	14 35	
4.7244 120.000	5.9055 150.000	+0 +0	-7 -18	9 23	9 23	5.5 14	12 30	16 40	
5.9055 150.000	7.0866 180.000	+0 +0	-10 -25	12 31	12 31	7.5 19	15 38	18 45	
7.0866 180.000	9.8425 250.000	+0 +0	-12 -30	15 38	15 38	9 23	— —	20 50	
9.8425 250.000	12.4015 315.000	+0 +0	-14 -35	17 44	17 44	10 26	— —	24 60	
12.4015 315.000	15.7480 400.000	+0 +0	-16 -40	20 50	20 50	12 30	— —	28 70	
15.7480 400.000	19.6850 500.000	+0 +0	-18 -45	22 56	22 56	13 34	— —	31 80	

** D Mean represents the Mean Outside Diameter Tolerance.
Out of Roundness represents the Maximum Outside Diameter Variation in a single radial plane.

Outer Ring Dowel Holes

Rotational or lateral movement of an outer ring can be prevented by doweling the ring in the housing. This method of mounting is used with either loosely fitted or heavily fitted rings as a precautionary measure. It is important that the blind dowel hole in the ring be located outside the load zone of the bearing.

The dowel holes are located centrally in the width of the outer ring and are identified by a letter "H" in the suffix of the bearing part number. Example: MR1310EHL. The dowel hole dimensions for each bearing size are charted below.

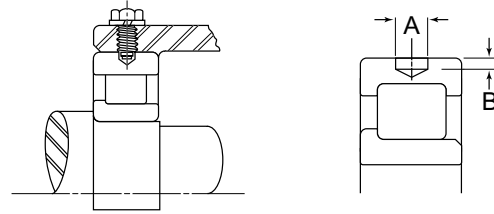

Basic Bearing Number									A	B		
'M' Series				'W' Series					Hole Diameter	Hole Depth		
1900	1000	1200 5200	1300 7300 5300	61900	61000	61200	67200	61300 67300		Inch/mm		
									Nominal	Maximum	Minimum	
911 THRU 916	007 THRU 010	205 THRU 206	304 THRU 305	911 THRU 920	007 THRU 011	205 THRU 207			0.281 7.14	0.600 1.52	0.040 1.02	
917 THRU 924	011 THRU 017	207 THRU 210		921 THRU 924	012 THRU 017	208 THRU 210			0.281 7.14	0.080 2.03	0.060 1.52	
					018 THRU 021	211	207 THRU 211		0.312 7.92	0.08 2.03	0.060 1.52	
926 THRU 928	018 THRU 021	211 THRU 215	306 THRU 309	925 THRU 228		212 THRU 216			0.312 7.92	0.110 2.79	0.090 2.29	
				930 THRU 934	022 THRU 024				0.375 9.52	0.110 2.79	0.090 2.29	
930 THRU 938	022 THRU 028	216 THRU 217	310 THRU 313	936 THRU 948	026 THRU 028				0.375 9.52	0.140 3.56	0.120 3.05	
							212 THRU 216	312 THRU 313	0.438 11.13	0.110 2.79	0.090 2.29	
						217 THRU 218	217 THRU 218		0.438 11.13	0.140 3.56	0.120 3.05	
940 THRU 964	030 THRU 064	218 THRU 228	314 THRU 321	952 THRU 964	030 THRU 064	219 THRU 232	219 THRU 232	314 THRU 320	0.438 11.13	0.180 4.57	0.160 4.06	
	230 THRU 264	322 THRU 340							0.500 12.7	0.210 5.33	0.180 4.57	
						234 THRU 264	234 THRU 264		0.500 12.7	0.210 5.33	0.190 4.83	

Outer Ring Groove & Snap Ring Dimensions

Outer rings can be retained axially in the housing bore by use of snap rings.

The groove and snap ring are identified by the letters G & R in the suffix of the bearing part number.

The groove without the snap ring is sometimes used as a puller groove to facilitate servicing.

Example: MU1310GCLR (Groove with snap ring)
MU1310GCL (Groove only)

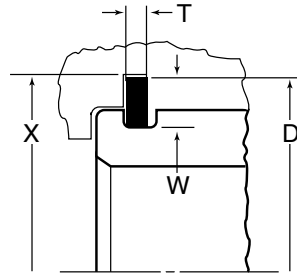
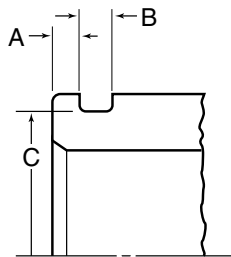

Series Number			A (Groove Location)		B	C		D	T	W	X
			1000-1900	1200-1300 5200-7300-5300	Groove Width	Groove Diameter		Snap Ring Diameter	Snap Ring Thickness	Snap Ring Height	Counter Bore
1000 1900	1200 5200	1300 7300 5300	Inch/mm								
			Nominal	Nominal	Nominal	Maximum	Tolerance	Nominal	Nominal	Nominal	Minimum
	1204			0.094 2.39	0.056 1.42	1.756 44.60	-0.010 -0.25	2.062 52.37	0.042 1.07	0.156 3.96	2.094 53.19
	1205	1304		0.094 2.39	0.056 1.42	1.958 49.73	-0.010 -0.25	2.266 57.56	0.042 1.07	0.156 3.96	2.297 59.34
1006			0.078 1.98		0.056 1.42	2.071 52.60	-0.010 -0.25	2.375 60.32	0.042 1.07	0.156 3.96	2.406 61.11
1007	1206	1305	0.078 1.98	0.125 3.18	0.078 1.98	2.347 59.61	-0.020 -0.51	2.656 67.46	0.065 1.65	0.156 3.96	2.688 68.28
1008			0.094 2.39		0.078 1.98	2.552 64.82	-0.020 -0.51	2.922 74.22	0.065 1.65	0.188 4.78	2.984 75.79
	1207	1306		0.125 3.18	0.078 1.98	2.709 68.81	-0.020 -0.51	3.078 78.18	0.065 1.65	0.188 4.78	3.141 79.78
1009			0.094 2.39		0.078 1.98	2.828 71.83	-0.020 -0.51	3.203 81.36	0.065 1.65	0.188 4.78	3.266 82.96
1010	1208	1307	0.094 2.39	0.125 3.18	0.078 1.98	3.024 76.81	-0.020 -0.51	3.406 86.51	0.065 1.65	0.188 4.78	3.469 88.11
1911			0.078 1.98		0.056 1.42	3.066 77.88	-0.020 -0.41	3.312 84.12	0.042 1.07	0.125 3.18	3.375 85.72
	1209			0.125 3.18	0.078 1.98	3.221 81.81	-0.020 -0.51	3.594 91.29	0.065 1.65	0.188 4.78	3.656 92.86
1912			0.078 1.98		0.056 1.42	3.263 82.88	-0.020 -0.41	3.516 89.31	0.042 1.07	0.125 3.18	3.578 90.88
1011	1210	1308	0.109 2.77	0.125 3.18	0.109 2.77	3.417 86.79	-0.020 -0.51	3.797 96.44	0.095 2.41	0.188 4.78	3.859 98.02
1913			0.078 1.98		0.056 1.42	3.459 87.86	-0.020 -0.41	3.703 94.06	0.042 1.07	0.125 3.18	3.766 95.66
1012			0.109 2.77		0.109 2.77	3.615 91.82	-0.020 -0.51	3.984 101.19	0.095 2.41	0.188 4.78	4.047 102.79
1013	1211	1309	0.109 2.77	0.125 3.18	0.109 2.77	3.811 96.80	-0.020 -0.41	4.188 106.38	0.095 2.41	0.188 4.78	4.250 107.95
1914			0.094 2.39		0.056 1.42	3.853 97.87	-0.020 -0.51	4.109 104.37	0.042 1.07	0.125 3.18	4.172 105.97

Outer Ring Groove & Snap Ring Dimensions

Series Number			A (Groove Location)		B	C		D	T	W	X
			1000-1900	1200-1300 5200-7300-5300	Groove Width	Groove Diameter		Snap Ring Diameter	Snap Ring Thickness	Snap Ring Height	Counter Bore
1000 1900	1200 5200	1300 7300 5300	Inch/mm								
			Nominal	Nominal	Nominal	Maximum	Tolerance	Nominal	Nominal	Nominal	Minimum
1915			0.094 2.39		0.056 1.42	4.040 102.62	-0.020 -0.51	4.359 110.72	0.042 1.07	0.156 3.96	4.422 112.32
1014	1212	1310	0.109 2.77	0.125 3.18	0.109 2.77	4.205 106.81	-0.020 -0.51	4.578 116.28	0.095 2.41	0.188 4.78	4.641 117.88
1916			0.094 2.39		0.056 1.42	4.237 107.62	-0.020 -0.51	4.457 115.49	0.042 1.07	0.156 3.96	4.609 117.07
1015			0.109 2.77		0.109 2.77	4.402 118.81	-0.020 -0.51	4.781 121.44	0.095 2.41	0.188 4.78	4.844 123.04
	1213	1311		0.156 3.96	0.125 3.18	4.536 115.21	-0.020 -0.51	5.094 129.39	0.109 2.77	0.281 7.14	5.156 130.96
1917			0.125 3.18		0.056 1.42	4.630 117.60	-0.020 -0.51	4.938 125.43	0.042 1.07	0.156 3.96	5.000 127.00
1016	1214		0.109 2.77	0.156 3.96	0.125 3.18	4.733 120.22	-0.020 -0.51	5.297 134.54	0.109 2.77	0.281 7.14	5.359 136.12
1918			0.125 3.18		0.056 1.42	4.827 122.61	-0.020 -0.51	5.141 130.58	0.042 1.07	0.156 3.96	5.203 132.16
1017	1215	1312	0.109 2.77	0.156 3.96	0.125 3.18	4.930 125.22	-0.020 -0.51	5.500 139.70	0.109 2.77	0.281 7.14	5.562 141.27
1919			0.125 3.18		0.056 1.42	5.024 127.61	-0.020 -0.51	5.328 135.33	0.042 1.07	0.156 3.96	5.391 136.93
1018	1216	1313	0.141 3.58	0.188 4.78	0.125 3.18	5.324 135.23	-0.020 -0.51	5.891 149.63	0.109 2.77	0.281 7.14	5.953 151.21
1920			0.125 3.18		0.078 1.98	5.418 137.62	-0.020 -0.51	5.734 145.64	0.065 1.65	0.156 3.96	5.797 147.24
1019			0.141 3.58		0.125 3.18	5.521 140.23	-0.020 -0.51	6.078 154.38	0.109 2.77	0.281 7.14	6.141 155.98
1921			0.125 3.18		0.078 1.98	5.615 142.62	-0.020 -0.51	5.922 150.42	0.065 1.65	0.156 3.96	5.984 151.99
1020	1217	1314	0.141 3.58	0.188 4.78	0.125 3.18	5.718 145.24	-0.020 -0.51	6.281 159.54	0.109 2.77	0.281 7.14	6.344 161.14
1922			0.125 3.18		0.078 1.98	5.812 147.62	-0.020 -0.51	6.125 155.58	0.065 1.65	0.156 3.96	6.188 157.18
1021	1218	1315	0.141 3.58	0.188 4.78	0.125 3.18	6.111 155.22	-0.020 -0.51	6.672 169.47	0.109 2.77	0.281 7.14	6.734 171.04
1924			0.141 3.58		0.078 1.98	6.371 161.82	-0.020 -0.51	6.750 171.45	0.065 1.65	0.188 4.78	6.812 173.02
1022	1219	1316	0.141 3.58	0.219 5.56	0.141 3.58	6.443 163.65	-0.020 -0.51	7.188 182.58	0.120 3.05	0.375 9.52	7.250 184.15

Internal Diametral Clearance

The internal diametral clearance for cylindrical roller bearings listed in this catalog are given on the following tables. Unlike ISO cylindrical and ball bearings whose diametral clearance follows ABMA/ANSI guidelines, Bower cylindricals are manufactured to a set clearance range. This range is designed to result in the optimal mounted clearance condition when using recommended Bower fitting practices as outlined in this catalog.

Special clearance ranges that fall outside those listed on the following tables can be manufactured on request. The part number for the bearing will reflect this special clearance range with a “CB” suffix followed the mean clearance condition in .0001 inches.

For example, MU1208UMCB40 would have a mean clearance value of .0040 inches, whereas the standard clearance condition is .00215 inches.

Internal Diametral Clearance For Standard "M" Series Cylindrical Roller Bearings

Bore Desig.	Basic "M" Series Radial Clearance — .0001 Inches/Micrometers																Bore Desig.
	-900 Standard		-900 "A" Style		-000 Standard		-000 "A" Style		-200 Standard		-200 "A" Style		-300 Standard		-300 "A" Style		
	Min	Max	Min	Max	Min	Max	Min	Max	Min	Max	Min	Max	Min	Max	Min	Max	
00					9	17	18	26	9	17	17	25	9	17	18	26	00
					23	43	46	66	23	43	43	64	23	43	46	66	
01					10	18	18	26	10	18	19	27	10	18	19	27	01
					25	46	46	66	25	46	48	69	25	46	48	69	
02					11	19	20	28	11	19	20	28	10	18	19	27	02
					28	48	51	71	28	48	51	71	25	46	48	69	
03					11	19	20	28	11	19	21	28	10	18	19	27	03
					28	48	51	71	28	48	51	71	25	46	48	69	
04	13	21	22	30	13	21	22	30	12	23	21	32	12	23	21	32	04
	33	53	56	76	33	53	56	76	30	58	53	81	30	58	53	81	
05	14	25	23	34	14	25	23	34	13	24	22	33	13	24	23	34	05
	36	64	58	86	36	64	58	86	33	61	56	84	33	61	58	86	
06	15	26	23	34	14	25	24	35	14	25	24	35	13	24	24	35	06
	38	66	58	86	36	64	61	89	36	64	61	89	33	61	61	89	
07	17	28	26	37	16	27	27	38	16	27	27	38	15	26	27	38	07
	43	71	66	94	41	69	69	97	41	69	69	97	38	66	69	97	
08	17	28	27	38	17	28	28	39	16	27	28	39	16	27	30	41	08
	43	71	69	97	43	71	71	99	41	69	71	99	41	69	76	104	
09	19	30	30	41	19	31	31	43	19	31	32	44	18	30	33	45	09
	48	76	76	104	48	79	79	109	48	79	81	112	46	76	84	114	
10	20	32	31	43	20	32	31	43	20	32	33	45	19	31	36	48	10
	51	81	79	109	51	81	79	109	51	81	84	114	49	79	91	122	
11	23	35	35	47	23	35	36	48	22	34	37	49	21	33	39	51	11
	58	89	89	119	58	89	91	122	56	86	94	124	53	84	99	130	
12	24	36	37	49	23	35	37	49	23	35	40	52	22	35	41	54	12
	61	91	94	124	58	89	94	124	58	89	102	132	56	89	104	137	
13	25	37	38	50	24	37	39	52	23	36	40	53	23	36	41	54	13
	64	94	97	127	61	94	99	132	58	91	102	135	58	91	104	137	
14	28	41	42	55	27	40	44	57	27	40	45	58	24	39	46	59	14
	71	104	107	140	69	102	112	145	69	102	114	147	66	99	117	150	
15	28	41	43	56	28	41	45	58	28	41	46	59	26	42	48	64	15
	71	104	109	142	71	104	114	147	71	104	117	150	66	107	122	163	
16	29	42	46	59	29	42	47	60	28	43	46	61	27	43	48	64	16
	74	107	117	150	74	107	119	152	71	109	117	155	69	109	122	163	
17	34	49	52	67	35	51	50	66	33	49	54	70	32	48	53	69	17
	86	124	132	170	89	130	127	168	84	124	137	178	81	122	135	175	
18	36	52	54	70	35	51	53	69	34	50	56	72	33	53	56	76	18
	91	132	137	178	89	130	135	175	86	127	142	183	84	135	142	193	

Internal Diametral Clearance For Standard "M" Series Cylindrical Roller Bearings (Cont'd)

Bore Desig.	Basic "M" Series Radial Clearance — .0001 Inches/Micrometers																Bore Desig.
	-900 Standard		-900 "A" Style		-000 Standard		-000 "A" Style		-200 Standard		-200 "A" Style		-300 Standard		-300 "A" Style		
	Min	Max	Min	Max	Min	Max	Min	Max	Min	Max	Min	Max	Min	Max	Min	Max	
19	36 91	52 132	54 137	70 178	36 91	52 132	56 142	73 183	34 86	50 127	56 142	72 183	33 84	53 135	57 145	77 196	19
20	37 94	53 135	55 140	71 180	36 91	52 132	56 142	72 183	35 89	53 135	56 142	74 188	34 86	55 140	59 150	80 203	20
21	37 94	55 140	58 147	76 193	37 94	55 140	58 147	76 193	36 91	55 140	59 150	78 198	34 86	55 140	61 155	82 208	21
22	38 97	56 142	58 147	76 193	37 94	56 142	59 150	78 198	36 91	55 140	60 152	79 201	34 86	55 140	63 160	84 213	22
24	39 99	58 147	61 155	80 203	38 94	57 145	60 152	79 201	37 94	56 142	63 160	82 208	36 91	58 147	66 168	88 224	24
26	45 114	64 163	66 168	85 216	44 112	63 160	68 173	87 221	43 109	63 150	70 178	90 229	41 104	63 160	71 180	93 236	26
28	47 119	67 170	70 178	90 229	46 117	68 173	70 178	92 234	44 112	66 168	73 185	95 241	42 107	68 173	75 191	101 257	28
30	53 135	75 191	78 198	100 254	53 135	75 191	79 201	101 257	50 127	72 183	80 203	102 259	49 124	76 193	84 213	111 282	30
32	55 140	77 196	81 206	103 262	54 137	76 193	83 211	105 267	52 132	75 191	84 213	107 272	50 127	77 196	85 216	112 284	32
34	57 145	80 203	84 213	109 272	55 140	78 198	85 216	108 284	53 135	76 193	86 218	109 277	52 132	79 201	88 224	115 292	34
36	58 147	81 206	86 218	109 277	57 145	80 203	86 218	109 277	55 140	80 203	90 229	115 292	53 135	81 206	89 226	117 297	36
38	65 165	88 224	95 241	118 300	64 163	89 226	96 244	121 307	61 155	87 221	97 246	123 312	59 150	87 221	96 244	124 315	38
40	67 170	93 236	97 246	123 312	65 165	91 231	98 249	124 315	63 160	91 231	99 251	127 323	62 157	91 231	101 257	130 330	40
44	70 178	96 244	103 262	129 328	68 173	94 239	104 264	130 330	66 168	95 241	103 262	132 335					44
48	74 188	101 257	109 277	136 345	72 183	99 251	108 274	135 343	71 180	100 254	109 277	138 351					48
52	80 203	107 272	117 297	144 366	79 201	108 274	115 292	144 366	77 196	107 272	116 295	146 371					52
56	84 213	114 290	120 305	150 381	84 213	114 290	122 310	152 386	81 206	111 282	120 305	150 381					56
60	88 224	118 300	124 320	156 396	87 221	117 297	126 320	156 396	84 213	115 292	126 320	157 399					60
64	97 249	128 325	136 345	166 422	97 246	128 325	136 345	167 424	93 236	124 315	135 343	166 422					64

Internal Diametral Clearance For Max-Pak "W" Series Cylindrical Roller Bearings

Bore Desig.	Max-Pak "W" Series Radial Clearance — .0001 Inches/Micrometers																Bore Desig.	
	6-900 Standard		6-900 "A" Style		6-000 Standard		6-000 "A" Style		6-200 Standard		6-200 "A" Style		6-300 Standard		6-300 "A" Style			
	Min	Max	Min	Max	Min	Max	Min	Max	Min	Max	Min	Max	Min	Max	Min	Max		
00														11	19	18	26	00
														28	48	46	66	
01														11	19	18	26	01
														28	48	46	66	
02														11	19	18	26	02
														28	48	46	66	
03														12	20	19	27	03
														30	51	48	69	
04									15	25		22	32	14	25	21	32	04
									38	64		56	81	36	64	53	81	
05									15	26		22	33	14	25	23	34	05
									38	66		56	84	36	64	58	86	
06					16	27	23	34	15	26	24	35	14	25	24	35	06	
					41	69	58	86	38	66	61	89	36	64	61	89		
07					18	29	27	38	17	28	27	38	17	28	27	38	07	
					46	74	69	97	43	71	69	97	43	71	69	97		
08					19	30	28	39	18	29	28	39	18	29	29	40	08	
					48	76	71	99	46	74	71	99	46	74	74	102		
09					22	33	31	42	22	34	32	44	21	33	33	45	09	
					56	84	79	107	56	86	81	112	53	84	84	114		
10					22	34	32	44	22	34	34	46	21	33	37	49	10	
					56	86	81	112	56	86	86	117	53	84	94	124		
11	26	38	36	48	26	38	37	49	25	37	38	50	24	36	39	51	11	
	66	97	91	122	66	97	94	124	64	94	97	127	61	91	99	130		
12	27	39	37	49	26	38	38	50	25	37	41	53	25	38	42	55	12	
	69	99	94	124	66	97	97	127	64	94	104	135	64	97	107	140		
13	28	40	39	51	27	39	40	52	26	39	41	54	26	39	42	55	13	
	71	102	99	130	69	99	102	132	66	99	104	137	66	99	107	140		
14	33	46	46	59	33	46	48	61	32	45	48	61	31	44	49	62	14	
	84	117	117	150	84	117	122	155	81	114	122	155	79	112	124	157		
15	34	47	47	60	33	46	49	62	33	46	49	62	31	46	51	66	15	
	86	119	119	152	84	117	124	157	84	117	124	157	79	117	130	168		
16	34	47	50	63	34	47	50	63	33	48	49	64	32	52	51	71	16	
	86	119	127	160	86	119	127	160	84	122	124	163	81	132	130	180		
17	40	53	56	69	41	54	57	70	39	55	57	73	37	57	57	77	17	
	102	135	142	175	104	137	145	178	99	140	145	185	94	145	145	196		
18	42	56	58	72	41	57	57	73	40	56	59	75	38	58	59	79	18	
	107	142	147	183	104	145	145	185	102	142	150	191	97	147	150	201		

Internal Diametral Clearance For Max-Pak "W" Series Cylindrical Roller Bearings (Cont'd)

Bore Desig.	Max-Pak "W" Series Radial Clearance — .0001 Inches/Micrometers																Bore Desig.
	6-900 Standard		6-900 "A" Style		6-000 Standard		6-000 "A" Style		6-200 Standard		6-200 "A" Style		6-300 Standard		6-300 "A" Style		
	Min	Max	Min	Max	Min	Max	Min	Max	Min	Max	Min	Max	Min	Max	Min	Max	
19	42	56	59	73	41	57	60	76	40	56	60	76	39	59	61	81	19
	107	142	150	185	104	145	152	193	102	142	152	193	99	150	155	206	
20	42	58	59	75	42	58	60	76	41	57	60	76	39	60	63	84	20
	107	147	150	191	107	147	152	193	104	145	152	193	99	152	160	213	
21	43	59	62	78	43	59	63	79	41	58	63	80	40	61	65	86	21
	109	150	157	198	109	150	160	201	104	147	160	203	102	155	165	218	
22	44	60	62	78	43	59	63	79	42	63	64	85	39	60	66	87	22
	112	152	157	198	109	150	160	201	107	160	163	216	99	152	168	221	
24	45	62	64	81	44	61	64	81	43	64	67	88	40	66	68	94	24
	114	157	163	206	112	155	163	206	109	163	170	224	102	168	173	239	
26	51	68	70	87	50	71	72	93	48	70	73	95	45	71	73	99	26
	130	173	178	221	127	180	183	236	122	178	185	241	114	180	185	251	
28	53	70	74	91	52	74	75	97	50	72	76	98	48	74	79	105	28
	135	178	188	231	132	188	191	246	127	183	193	249	122	188	201	267	
30	60	82	83	105	59	81	84	106	56	78	84	106	54	81	88	115	30
	152	208	211	267	150	206	213	269	142	198	213	269	137	206	224	292	
32	62	84	86	108	61	83	87	109	57	80	87	110	55	85	89	116	32
	157	213	218	274	155	211	221	277	145	203	221	279	140	208	226	295	
34	64	86	89	111	64	84	90	113	59	82	90	113	57	84	91	118	34
	163	218	226	282	155	213	229	287	150	208	229	287	145	213	231	300	
36	65	88	91	114	63	86	91	114	60	83	94	117	58	86	93	121	36
	165	224	231	290	160	218	231	290	152	211	239	297	147	218	236	307	
38	75	98	103	126	73	96	103	126	70	98	104	132	67	95	102	130	38
	191	249	262	320	185	244	262	320	178	249	264	335	170	241	259	330	
40	76	99	104	127	75	99	106	130	72	100	106	134	72	100	108	136	40
	193	251	264	323	191	251	269	330	183	254	269	340	183	254	274	345	
44	80	104	111	135	78	102	112	136	74	103	109	138					44
	203	264	282	343	198	259	284	345	188	262	277	351					
48	83	108	117	142	82	107	116	141	79	108	116	145					48
	211	274	297	361	208	272	295	358	201	274	295	368					
52	93	124	127	158	91	120	125	154	89	119	126	156					52
	236	315	323	401	231	305	318	391	226	302	320	396					
56	96	127	131	162	97	127	133	163	92	122	129	159					56
	244	323	333	411	246	323	338	414	234	310	328	404					
60	101	133	137	169	98	128	135	165	95	126	134	165					60
	257	338	348	429	249	325	343	419	241	320	340	419					
64	117	149	153	185	115	146	152	183	109	140	149	180					64
	297	378	389	470	292	371	386	465	277	356	378	457					

General Fitting Practice

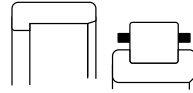

Separable Bearings

Shaft	Inner Ring Fit	Page	Outer Ring Fit	Page
Rotating	Press	91-92	Tap	97-98
Stationary	Tap	93-94	Press	99-100



MU----TV, MU----UV, MU----TM, MU----UM

Non-Separable Bearings

Shaft	Inner Ring Fit	Page	Outer Ring Fit	Page
Rotating	Press	91-92	Push	95-96

* "A" Style Fitting Practice

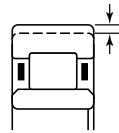

Identified by suffix letter "A" in part number

Over Size O.D.

Shaft	Inner Ring Fit	Page	Outer Ring Fit	Page
Rotating or Stationary	Press	91-92	Heavy Press*	101-102

Inner or Outer Ring Omitted



M----EL, M----TV

Inner Ring Omitted

Shaft	Inner Ring Fit	Page	Outer Ring Fit	Page
Rotating	Shaft Dia.	103	Tap/Heavy Press*	97-98/101-102
Stationary	Shaft Dia.	109	Press	91-92

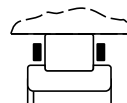

MU----L, MU----V

Outer Ring Omitted

Shaft	Inner Ring Fit	Page	Outer Ring Fit	Page
Rotating	Press	91-92	Housing Bore	106
Stationary	Tap	93-94	Housing Bore	105

* Over size outer ring for heavy press fit in standard (tap fit) size housing bore.

NOTE: The NTN Engineering Department should be consulted for any modification of the above fitting practice.

Fitting Practice

The fitting practice given in the following tables conforms to industry and ABMA/ANSI standards, where applicable. The tables provide maximum and minimum sizes for bearing bore and O.D., shaft and housing bore, and the resultant effects of each type of fit.

Dimensions are given in both inch and metric units with deviations in .0001 inch and micrometers.

The looseness or tightness of a ring mounted on a shaft or in a housing bore depends on the conditions under which the bearing will operate and how it will be installed. The three most generally used fits are: PRESS, TAP AND PUSH.

PRESS fit is used to fit a ring tightly to a rotating member (shaft or housing) to prevent creep or slippage that could result in damage to the shaft or housing bore.

TAP fit usually accompanies PRESS fit, for fitting the opposite ring to the stationary member, if the bearing rings are separable.

PUSH fit is used instead of TAP, for a stationary outer ring, if the bearing is non-separable.

HEAVY PRESS fit ("A" style) is an NTN-Bower innovation for cylindrical roller bearings. It is used to prevent the outer ring from turning in the housing bore, where the bearing is operating under very heavy loads. The outer ring O.D. is made oversize to provide a heavy press fit in a standard (tap fit) size housing bore. The accompanying inner ring uses a PRESS fit on the shaft.

The catalog fitting practice does not apply to bearings mounted on hollow shafts or in housings of materials softer than steel, such as aluminum. Since these conditions usually require heavier press fits, the NTN Engineering Department should be consulted for recommendation.

The chart on the opposite page summarizes the recommended fitting practice for various installations and bearing types, including bearings with inner or outer rings omitted.

Inner Ring PRESS Fit for Rotating Shaft

Basic Bearing Number	Bearing Dimensions		Shaft Diameter		Resultant Fit		ABMA Fit Class
	Inch/mm				.0001 Inch/Micrometers		
	Maximum	Minimum	Maximum	Minimum	Tight	Tight	
04	0.7874 20.000	0.7870 19.990	0.7881 20.017	0.7877 20.008	3T 8T	11T 27T	m5
05	0.9843 25.000	0.9839 24.990	0.9850 25.017	0.9846 25.008	3T 8T	11T 27T	
06	1.1811 30.000	1.1807 29.990	1.1818 30.017	1.1814 30.008	3T 8T	11T 27T	
07	1.3780 35.000	1.3776 34.988	1.3788 35.020	1.3784 35.009	4T 9T	12.5T 32T	
08	1.5748 40.000	1.5744 39.988	1.5756 40.020	1.5752 40.009	4T 9T	12.5T 32T	m6
09	1.7717 45.000	1.7713 44.988	1.7727 45.025	1.7721 45.009	4T 9T	14.5T 37T	
10	1.9685 50.000	1.9681 49.988	1.9695 50.025	1.9689 50.009	4T 9T	14.5T 37T	
11	2.1654 55.000	2.1648 54.985	2.1666 55.030	2.1658 55.011	4T 11T	18T 45T	n6
12	2.3622 60.000	2.3616 59.985	2.3634 60.030	2.3626 60.011	4T 11T	18T 45T	
13	2.5591 65.000	2.5585 64.985	2.5603 65.030	2.5595 65.011	4T 11T	18T 45T	
14	2.7559 70.000	2.7553 69.985	2.7574 70.039	2.7567 70.020	8T 20T	21T 54T	n6
15	2.9528 75.000	2.9522 74.985	2.9543 75.039	2.9536 75.020	8T 20T	21T 54T	
16	3.1496 80.000	3.1490 79.985	3.1511 80.039	3.1504 80.020	8T 20T	21T 54T	
17	3.3465 85.000	3.3457 84.980	3.3483 85.045	3.3474 85.023	9T 23T	26T 65T	
18	3.5433 90.000	3.5425 89.980	3.5451 90.045	3.5442 90.023	9T 23T	26T 65T	n6
19	3.7402 95.000	3.7394 94.980	3.7420 95.045	3.7411 95.023	9T 23T	26T 65T	
20	3.9370 100.000	3.9362 99.980	3.9388 100.045	3.9379 100.023	9T 23T	26T 65T	

Inner Ring PRESS Fit for Rotating Shaft (Cont.)

Basic Bearing Number	Bearing Dimensions		Shaft Diameter		Resultant Fit		ABMA Fit Class
	Inch/mm				.0001 Inch/Micrometers		
	Maximum	Minimum	Maximum	Minimum	Tight	Tight	
21	4.1339 105.000	4.1331 104.980	4.1357 105.045	4.1348 105.023	9T 23T	26T 65T	n6
22	4.3307 110.000	4.3299 109.980	4.3325 110.045	4.3316 110.023	9T 23T	26T 65T	
24	4.7244 120.000	4.7236 119.980	4.7262 120.045	4.7253 120.023	9T 23T	26T 65T	
26	5.1811 130.000	5.1171 129.975	5.1201 130.052	5.1192 130.027	11T 27T	30T 77T	
28	5.5118 140.000	5.5108 139.975	5.5138 140.052	5.5129 140.027	11T 27T	30T 77T	p6
30	5.9055 150.000	5.9045 149.975	5.9082 150.068	5.9072 150.043	17T 43T	37T 93T	
32	6.2292 160.000	6.2982 159.925	6.3019 160.068	6.3009 160.043	17T 43T	37T 93T	
34	6.6929 170.000	6.6919 169.975	6.6956 170.068	6.6946 170.043	17T 43T	37T 93T	
36	7.0866 180.000	7.0856 179.975	7.0893 180.068	7.0883 180.043	17T 43T	37T 93T	
38	7.4803 190.000	7.4791 189.970	7.4834 190.079	7.4823 190.050	20T 50T	43T 109T	
40	7.8740 200.000	7.8728 199.970	7.8771 200.079	7.8760 200.050	20T 50T	43T 109T	
44	8.6614 220.000	8.6602 219.970	8.6645 220.079	8.6634 220.050	20T 50T	43T 109T	
48	9.4488 240.000	9.4476 239.970	9.4519 240.079	9.4508 240.050	20t 50T	43t 109T	
52	10.2362 260.000	10.2348 259.965	10.2397 260.088	10.2384 260.056	22T 56T	49T 123T	
56	11.0236 280.000	11.0222 279.965	11.0271 280.088	11.0258 280.056	22T 56T	49T 123T	
60	11.8110 300.000	11.8096 299.965	11.8145 300.088	11.8132 300.056	22T 56T	49T 123T	
64	12.5984 320.000	12.5968 319.960	12.6023 320.098	12.6008 320.062	24T 62T	55T 138T	

Inner Ring TAP Fit for Stationary Shaft

Basic Bearing Number	Bearing Dimensions		Shaft Diameter		Resultant Fit		ABMA Fit Class
	Inch/mm				.0001 Inch/Micrometers		
	Maximum	Minimum	Maximum	Minimum	Loose	Tight	
04	0.7874 20.000	0.7870 19.990	0.7874 20.000	0.7869 19.987	5L 13L	4T 10T	
05	0.9843 25.000	0.9839 24.990	0.9843 25.000	0.9838 24.987	5L 13L	4T 10T	
06	1.1811 30.000	1.1807 29.990	1.1877 30.000	1.1806 29.987	5L 13L	4T 10T	
07	1.3780 35.000	1.3776 34.988	1.3780 35.000	1.3774 34.984	6L 16L	4.5T 12T	
08	1.5748 40.000	1.5744 39.988	1.5748 40.000	1.5742 39.984	6L 16L	4.5t 12t	
09	1.7717 45.000	1.7713 44.988	1.7717 45.000	1.7711 44.984	6L 16L	4.5T 12T	
10	1.9685 50.000	1.9681 49.988	1.9685 50.000	1.9679 49.984	6L 16L	4.5T 12T	
11	2.1654 55.000	2.1648 54.985	2.1654 55.000	2.1647 54.981	7L 19L	6T 15T	
12	2.3622 60.000	2.3616 59.985	2.3622 60.000	2.3615 59.981	7L 19L	6T 15T	
13	2.5591 65.000	2.5585 64.985	2.5591 65.000	2.5584 64.981	7L 19L	6T 15T	
14	2.7559 70.000	2.7553 69.985	2.7559 70.000	2.7552 69.981	7L 19L	6T 15T	
15	2.9528 75.000	2.9522 74.985	2.9528 75.000	2.9521 74.981	7L 19L	6T 15T	
16	3.1496 80.000	3.1490 79.985	3.1496 80.000	3.1489 79.981	7L 19L	6T 15T	
17	3.3465 85.000	3.3457 84.980	3.3465 85.000	3.3456 84.978	9L 22L	8T 20T	
18	3.5433 90.000	3.5425 89.980	3.5433 90.000	3.5424 89.978	9L 22L	8T 20T	
19	3.7402 95.000	3.7394 94.980	3.7402 95.000	3.7393 94.978	9L 22L	8T 20T	
20	3.9370 100.000	3.9362 99.980	3.9370 100.000	3.9361 99.978	9L 22L	8T 20T	

Inner Ring TAP Fit for Stationary Shaft (Cont.)

Basic Bearing Number	Bearing Dimensions		Shaft Diameter		Resultant Fit		ABMA Fit Class
	Inch/mm				.0001 Inch/Micrometers		
	Maximum	Minimum	Maximum	Minimum	Loose	Tight	
21	4.1339 105.000	4.1331 104.980	4.1339 105.000	4.1330 104.978	9L 22L	8T 20T	 h6
22	4.3307 110.000	4.3299 109.980	4.3307 110.000	4.3298 109.978	9L 22L	8T 20T	
24	4.7244 120.000	4.7236 119.980	4.7244 120.000	4.7235 119.978	9L 22L	8T 20T	
26	5.1181 130.000	5.1171 129.975	5.1181 130.000	5.1171 129.975	10L 25L	10T 25T	
28	5.5118 140.000	5.5108 139.975	5.5118 140.000	5.5108 139.975	10L 25L	10T 25T	
30	5.9055 150.000	5.9045 149.975	5.9055 150.000	5.9045 149.975	10L 25L	10T 25T	
32	6.2992 160.000	6.2982 159.975	6.2992 160.000	6.2982 159.975	10L 25L	10T 25T	
34	6.6929 170.000	6.6919 169.975	6.6929 170.000	6.6919 169.975	10L 25L	10T 25T	
36	7.0866 180.000	7.0856 179.975	7.0866 180.000	7.0856 179.975	10L 25L	10T 25T	
38	7.4803 190.000	7.4791 189.970	7.4803 190.000	7.4792 189.971	11L 29L	12T 30T	
40	7.8740 200.000	7.8728 199.970	7.8740 200.000	7.8729 199.971	11L 29L	12T 30T	
44	8.6614 220.000	8.6602 219.970	8.6614 220.000	8.6603 219.971	11L 29L	12T 30T	
48	9.4488 240.000	9.4476 239.970	9.4488 240.000	9.4477 239.971	11L 29L	12T 30T	
52	10.2362 260.000	10.2348 259.965	10.2362 260.000	10.2349 259.968	13L 32L	14T 35T	
56	11.0236 280.000	11.0222 279.965	11.0236 280.000	11.0223 279.968	13L 32L	14T 35T	
60	11.8110 300.000	11.8096 299.965	11.8110 300.000	11.8097 299.968	13L 32L	14T 35T	
64	12.5984 320.000	12.5968 319.960	12.5984 320.000	12.5970 319.964	14L 36L	16T 40T	

Outer Ring PUSH Fit for Non-Separable Bearings

Use with Press Fit Inner Ring

Basic Bearing Number				Bearing Outside Diameter		Housing Bore		Resultant Fit		ABMA Fit Class
1900	1000	1200 5200	1300 7300 5300	Inch/mm				.0001 Inch/Micrometers		
				Maximum	Minimum	Maximum	Minimum	Loose	Tight	
		204		1.8504 47.000	1.8495 46.989	1.8514 47.025	1.8504 47.000	14.5L 36L	LINE TO LINE 	H7
		205	304	2.0472 52.000	2.0467 51.987	2.0484 52.030	2.0472 52.000	17L 43L		
	006			2.1654 55.000	2.1649 54.987	2.1666 55.030	2.1654 55.000	17L 43L		
	007	206	305	2.4409 62.000	2.4404 61.978	2.4421 62.030	2.4409 62.000	17L 43L		
	008			2.6772 68.000	2.6767 67.987	2.6784 68.030	2.6772 68.000	17L 43L		
		207	306	2.8346 72.000	2.8341 71.987	2.8358 72.030	2.8346 72.000	17L 43L		
	009			2.9528 75.000	2.9523 74.987	2.9540 75.030	2.9528 75.000	17L 43L		
911	010	208	307	3.1496 80.000	3.1491 79.987	3.1508 80.030	3.1496 80.000	17L 43L		
912		209		3.3465 85.000	3.3459 84.985	3.3479 85.035	3.3465 85.000	20L 50L		
913	011	210	308	3.5433 90.000	3.5427 89.985	3.5447 90.035	3.5433 90.000	20L 50L		
	012			3.7402 95.000	3.7396 94.985	3.7416 95.035	3.7402 95.000	20L 50L		
914	013	211	309	3.9370 100.000	3.9364 99.985	3.9384 100.035	3.9370 100.000	20L 50L		
915				4.1339 105.000	4.1333 104.985	4.1353 105.035	4.1339 105.000	20L 50L		
916	014	212	310	4.3307 110.000	4.3301 109.985	4.3321 110.035	4.3307 110.000	20L 50L		
	015			4.5276 115.000	4.5270 114.985	4.5290 115.035	4.5276 115.000	20L 50L		
917		213	311	4.7244 120.000	4.7238 119.985	4.7258 120.035	4.7244 120.000	20L 50L		
918	016	214		4.9213 125.000	4.9206 124.982	4.9299 125.040	4.9213 125.000	23L 58L		
919	017	215	312	5.1181 130.000	5.1174 129.982	5.1197 130.040	5.1181 130.000	23L 58L		
920	018	216	313	5.5118 140.000	5.5111 139.982	5.5134 140.040	5.5118 140.000	23L 58L		
921	019			5.7087 145.000	5.7080 144.982	5.7103 145.040	5.7087 145.000	23L 58L		
922	020	217	314	5.9055 150.000	5.9048 149.982	5.9071 150.040	5.9055 150.000	23L 58L		
	021	218	315	6.2992 160.000	6.2982 159.975	6.3008 160.040	6.2992 160.000	26L 65L		
924				6.4961 165.000	6.4951 164.975	6.4977 165.040	6.4961 165.000	26L 65L		
	022	219	316	6.6929 170.000	6.6919 169.975	6.6945 170.040	6.6929 170.000	26L 65L		

Outer Ring PUSH Fit for Non-Separable Bearings (Cont.)

Use with Press Fit Inner Ring

Basic Bearing Number				Bearing Outside Diameter		Housing Bore		Resultant Fit		ABMA Fit Class
1900	1000	1200 5200	1300 7300 5300	Inch/mm				.0001 Inch/Micrometers		
				Maximum	Minimum	Maximum	Minimum	Loose	Tight	
926	024	220	317	7.0866 180.000	7.0856 179.975	7.0882 180.040	7.0866 180.000	26L 65L	LINE TO LINE 	H7
928		221	318	7.4803 190.000	7.4791 189.970	7.4821 190.046	7.4803 190.000	30L 76L		
	026	222	319	7.8740 200.000	7.8728 199.970	7.8758 200.046	7.8740 200.000	30L 76L		
930	028			8.2677 210.000	8.2665 209.970	8.2695 210.046	8.2677 210.000	30L 76L		
		224	320	8.4646 215.000	8.4634 214.970	8.4664 215.046	8.4646 215.000	30L 76L		
932				8.6614 220.000	8.6602 219.970	8.6632 220.046	8.6614 220.000	30L 76L		
	030		321	8.8583 225.000	8.8571 224.970	8.8601 225.046	8.8583 225.000	30L 76L		
934		226		9.0551 230.000	9.0539 229.970	9.0569 230.046	9.0551 230.000	30L 76L		
	032		322	9.4488 240.000	9.4476 239.970	9.4506 240.046	9.4488 240.000	30L 76L		
936		228		9.8425 250.000	9.8413 249.970	9.8443 250.046	9.8425 250.000	30L 76L		
938	034		324	10.2362 260.000	10.2348 259.965	10.2382 260.052	10.2362 260.000	34L 87L		
		230		10.6299 270.000	10.6285 269.965	10.6319 270.052	10.6299 270.000	34L 87L		
940	036		326	11.0236 280.000	11.0222 279.965	11.0256 280.052	11.0236 280.000	34L 87L		
	038	232		11.4173 290.000	11.4159 289.965	11.4193 290.052	11.4173 290.000	34L 87L		
944			328	11.8110 300.000	11.8096 299.965	11.8130 300.052	11.8110 300.000	34L 87L		
	040	234		12.2047 310.000	12.2033 309.965	12.2067 310.052	12.2047 310.000	34L 87L		
948		236	330	12.5984 320.000	12.5967 319.960	12.6006 320.057	12.5984 320.000	38L 97L		
	044	238	332	13.3858 340.000	13.3842 339.960	13.3880 340.057	13.3858 340.000	38L 97L		
952	048	240	334	14.1732 360.000	14.1716 359.960	14.1754 360.057	14.1732 360.000	38L 97L		
956			336	14.9606 380.000	14.9590 379.960	14.9628 380.057	14.9606 380.000	38L 97L		
	052	244	338	15.7480 400.000	15.7464 399.960	15.7502 400.057	15.7480 400.000	38L 97L		
960	056		340	16.5354 420.000	16.5336 419.955	16.5379 420.063	16.5354 420.000	43L 108L		
964		248		17.3228 440.000	17.3210 439.955	17.3253 440.063	17.3228 440.000	43L 108L		
		252		18.8976 480.000	18.8958 479.955	18.9001 480.063	18.8976 480.000	43L 108L		
		256		19.6850 500.000	19.6832 499.955	19.6875 500.063	19.6850 500.000	43L 108L		

Outer Ring TAP Fit for Rotating Shaft

Basic Bearing Number				Bearing Outside Diameter		Housing Bore		Resultant Fit		ABMA Fit Class
1900	1000	1200 5200	1300 7300 5300	Inch/mm				.0001 Inch/Micrometers		
				Maximum	Minimum	Maximum	Minimum	Loose	Tight	
		204		1.8504 47.000	1.8500 46.989	1.8510 47.014	1.8500 46.989	10.5L 25L	4T 11T	 J7
		205	304	2.0472 52.000	2.0467 51.987	2.0479 52.018	2.0467 51.988	12L 31L	5T 12T	
	006			2.1654 55.000	2.1649 54.987	2.1661 55.018	2.1649 54.988	12L 31L	5T 12T	
	007	206	305	2.4490 62.000	2.4404 61.987	2.4416 62.018	2.4404 61.988	12L 31L	5T 12T	
	008			2.6772 68.000	2.6767 67.987	2.6779 68.018	2.6767 67.988	12L 31L	5T 12T	
		207	306	2.8346 72.000	2.8341 71.987	2.8353 72.018	2.8341 71.988	12L 31L	5T 12T	
	009			2.9528 75.000	2.9523 74.987	2.9535 75.018	2.9523 74.988	12L 31L	5T 12T	
911	010	208	307	3.1496 80.000	3.1491 79.987	3.1503 80.018	3.1491 79.988	12L 31L	5T 12T	
912		209		3.3465 85.000	3.3459 84.985	3.3474 85.022	3.3460 84.987	15L 37L	5T 13T	
913	011	210	308	3.5433 90.000	3.5427 89.985	3.5442 90.022	3.5428 89.987	15L 37L	5T 13T	
	012			3.7402 95.000	3.7396 94.985	3.7411 95.022	3.7397 94.987	15L 37L	5T 13T	
914	013	211	309	3.9370 100.000	3.9364 99.985	3.9379 100.022	3.9365 99.987	15L 37L	5T 13T	
915				4.1339 105.000	4.1333 104.985	4.1348 105.022	4.1334 104.987	15L 37L	5T 13T	
916	014	212	310	4.3307 110.000	4.3301 109.985	4.3316 110.022	4.3302 109.987	15L 37L	5T 13T	
	015			4.5276 115.000	4.5270 114.985	4.5285 115.022	4.5271 114.987	15L 37L	5T 13T	
917		213	311	4.7244 120.000	4.7238 119.985	4.7253 120.022	4.7239 119.987	15L 37L	5T 13T	
918	016	214		4.9213 125.000	4.9206 124.982	4.9223 125.026	4.9207 124.986	17L 44L	6T 14T	
919	017	215	312	5.1181 130.000	5.1174 129.982	5.1191 130.026	5.1175 129.986	17L 44L	6T 14T	
920	018	216	313	5.5118 140.000	5.5111 139.982	5.5128 140.026	5.5112 139.986	17L 44L	6T 14T	
921	019			5.7087 145.000	5.7080 144.982	5.7097 145.026	5.7081 144.986	17L 44L	6T 14T	
922	020	217	314	5.9055 150.000	5.9048 149.982	5.9065 150.026	5.9049 149.986	17L 44L	6T 14T	
	021	218	315	6.2992 160.000	6.2982 159.975	6.3002 160.026	6.2986 159.986	20L 51L	6T 14T	
924				6.4961 165.000	6.4951 164.975	6.4971 165.026	6.4955 164.986	20L 51L	6T 14T	
	022	219	316	6.6929 170.000	6.6919 169.975	6.6939 170.026	6.6923 169.986	20L 51L	6T 14T	

Outer Ring TAP Fit for Rotating Shaft

Basic Bearing Number				Bearing Outside Diameter		Housing Bore		Resultant Fit		ABMA Fit Class
1900	1000	1200 5200	1300 7300 5300	Inch/mm				.001 Inch/Micrometers		
				Maximum	Minimum	Maximum	Minimum	Loose	Tight	
926	024	220	317	7.0866 180.000	7.0856 179.975	7.0876 180.026	7.0860 179.986	20L 51L	6T 14T	 J7
928		221	318	7.4030 190.000	7.4791 189.970	7.4815 190.030	7.4797 189.984	24L 60L	6T 16T	
	026	222	319	7.8740 200.000	7.8728 199.970	7.8752 200.030	7.8734 199.984	24L 60L	6T 16T	
930	028			8.2677 210.000	8.2665 209.970	8.2689 210.030	8.2671 209.984	24L 60L	6T 16T	
		224	320	8.4646 215.000	8.4634 214.970	8.4658 215.030	8.4640 214.984	24L 60L	6T 16T	
932				8.6614 220.000	8.6602 219.970	8.6626 220.030	8.6608 219.984	24L 60L	6T 16T	
	030		321	8.8583 225.000	8.8571 224.970	8.8595 225.030	8.8577 224.984	24L 60L	6T 16T	
934		226		9.0551 230.000	9.0539 229.970	9.0563 230.030	9.0545 229.984	24L 60L	6T 16T	
	032		322	9.4488 240.000	9.4476 239.970	9.4500 240.030	9.4482 239.984	24L 60L	6T 16T	
936		228		9.8425 250.000	9.8413 249.970	9.8437 250.030	9.8419 249.984	24L 60L	6T 16T	
938	034		324	10.2362 260.000	10.2348 259.965	10.2376 260.036	10.2356 259.984	28L 71L	6T 16T	
		230		10.6299 270.000	10.6285 269.965	10.6313 270.036	10.6293 269.984	28L 71L	6T 16T	
940	036		326	11.0236 280.000	11.0222 279.965	11.0250 280.036	11.0230 279.984	28L 71L	6T 16T	
	038	232		11.4173 290.000	11.4159 289.965	11.4187 290.036	11.4167 289.984	28L 71L	6T 16T	
944			328	11.8110 300.000	11.8096 299.965	11.8124 300.036	11.8104 299.984	28L 71L	6T 16T	
	040	234		12.2047 310.000	12.2033 309.965	12.2061 310.036	12.2041 309.984	28L 71L	6T 16T	
948		236	330	12.5984 320.000	12.5968 319.960	12.5999 320.039	12.5977 319.982	31L 79L	7T 18T	
	044	238	332	13.3858 340.000	13.3842 339.960	13.3873 340.039	13.3851 339.982	31L 79L	7T 18T	
952	048	240	334	14.1732 360.000	14.1716 359.960	14.1747 360.039	14.1725 359.982	31L 79L	7T 18T	
956			336	14.9606 380.000	14.9590 379.960	14.9621 380.039	14.9599 379.982	31L 79L	7T 18T	
	052	244	338	15.7480 400.000	15.7464 399.960	15.7495 400.039	15.7473 399.982	31L 79L	7T 18T	
960	056		340	16.5354 420.000	16.5336 419.955	16.5371 420.043	16.5346 419.980	35L 88L	8T 20T	
964		248		17.3228 440.000	17.3210 439.955	17.3245 440.043	17.3220 439.980	35L 88L	8T 20T	
		252		18.8976 480.000	18.8958 479.955	18.8993 480.043	18.8968 479.980	35L 88L	8T 20T	
		256		19.6850 500.000	19.6832 499.955	19.6867 500.043	19.6842 499.980	35L 88L	8T 20T	

Outer Ring PRESS Fit for Stationary Shaft

Basic Bearing Number				Bearing Outside Diameter		Housing Bore		Resultant Fit		ABMA Fit Class
1900	1000	1200 5200	1300 7300 5300	Inch/mm				.0001 Inch/Micrometers		
				Maximum	Minimum	Maximum	Minimum	Loose	Tight	
		204		1.8504 47.000	1.8500 46.989	1.8501 46.992	1.8491 46.967	1.5L 3L	13T 33T	 N7
		205	304	2.0472 52.000	2.0467 51.987	2.0468 51.991	2.0457 51.961	1L 4L	15T 39T	
	006			2.1654 55.000	2.1649 54.987	2.1650 54.991	2.1639 54.961	1L 4L	15T 39T	
	007	206	305	2.4409 62.000	2.4404 61.987	2.4405 61.991	2.4394 61.961	1L 4L	15T 39T	
	008			2.6772 68.000	2.6767 67.987	2.6768 67.991	2.6757 67.961	1L 4L	15T 39T	
		207	306	2.8346 72.000	2.8341 71.987	2.8342 71.991	2.8331 71.961	1L 4L	15T 39T	
	009			2.9528 75.000	2.9523 74.987	2.9524 74.991	2.9513 74.961	1L 4L	15T 39T	
911	010	208	307	3.1496 80.000	3.1491 79.987	3.1492 79.991	3.1481 79.961	1L 4L	15T 39T	
912		209		3.3465 85.000	3.3459 84.985	3.3461 84.990	3.3447 84.955	2L 5L	18T 45T	
913	011	210	308	3.5433 90.000	3.5427 89.985	3.5429 89.990	3.5415 89.955	2L 5L	18T 45T	
	012			3.7402 95.000	3.7396 94.985	3.7398 94.990	3.7384 94.955	2L 5L	18T 45T	
914	013	211	309	3.9370 100.000	3.9364 99.985	3.9366 99.990	3.9352 99.955	2L 5L	18T 45T	
915				4.1339 105.000	4.1333 104.985	4.1335 104.990	4.1321 104.955	2L 5L	18T 45T	
916	014	212	310	4.3307 110.000	4.3301 109.985	4.3303 109.990	4.3289 109.955	2L 5L	18T 45T	
	015			4.5276 115.000	4.5270 114.985	4.5272 114.990	4.5258 114.955	2L 5L	18T 45T	
917		213	311	4.7244 120.000	4.7238 119.985	4.7240 119.990	4.7226 119.955	2L 5L	18T 45T	
918	016	214		4.9213 125.000	4.9206 124.982	4.9208 124.988	4.9193 124.948	2L 6L	20T 52T	
919	017	215	312	5.1181 130.000	5.1174 129.982	5.1176 129.988	5.1161 124.948	2L 6L	20T 52T	
920	018	216	313	5.5118 140.000	5.5111 139.982	5.5113 139.988	5.5098 139.948	2L 6L	20T 52T	
921	019			5.7087 145.000	5.7080 144.982	5.7082 144.988	5.7067 144.948	2L 6L	20T 52T	
922	020	217	314	5.9055 150.000	5.9048 149.982	5.9050 149.982	5.9035 149.948	2L 6L	20T 52T	
	021	218	315	6.2992 160.000	6.2982 159.975	6.2987 159.988	6.2972 159.948	5L 13L	20T 52T	
924				6.4961 165.000	6.4951 164.975	6.4956 164.988	6.4941 164.948	5L 13L	20T 52T	
	022	219	316	6.6929 170.000	6.6919 169.975	6.6924 169.988	6.6909 169.948	5L 13L	20T 52T	

Outer Ring PRESS Fit for Stationary Shaft

Basic Bearing Number				Bearing Outside Diameter		Housing Bore		Resultant Fit		ABMA Fit Class
1900	1000	1200 5200	1300 7300 5300	Inch/mm				.0001 Inch/Micrometers		
				Maximum	Minimum	Maximum	Minimum	Loose	Tight	
926	024	220	317	7.0866	7.0856	7.0861	7.0846	5L	20T	 N7
				180.000	179.975	179.988	179.948	13L	52T	
928	026	222	319	7.4803	7.4791	7.4797	7.4779	6L	24T	
				190.000	189.970	189.986	189.940	16L	60T	
930	028	224	320	7.8740	7.8728	7.8734	7.8716	6L	24T	
				200.000	199.970	199.986	199.940	16L	60T	
932	030	226	321	8.2677	8.2665	8.2671	8.2653	6L	24T	
				210.000	209.970	209.986	209.940	16L	60T	
934	032	228	322	8.4646	8.4634	8.4640	8.4622	6L	24T	
				215.000	214.970	214.986	214.940	16L	60T	
938	034	230	324	8.6614	8.6602	8.6608	8.6590	6L	24T	
				220.000	219.970	219.986	219.940	16L	60T	
940	036	232	326	8.8583	8.8571	8.8577	8.8559	6L	24T	
				225.000	224.970	224.986	224.940	16L	60T	
944	038	234	328	9.0551	9.0539	9.0545	9.0527	6L	24T	
				230.000	229.970	229.986	229.940	16L	60T	
948	040	236	330	9.4488	9.4476	9.4482	9.4464	6L	24T	
				250.000	249.970	249.986	249.940	16L	60T	
952	044	238	332	10.2362	10.2348	10.2356	10.2336	8L	26T	
				260.000	259.965	259.986	259.934	21L	66T	
956	048	240	334	10.6299	10.6285	10.6293	10.6273	8L	26T	
				270.000	269.965	269.986	269.934	21L	66T	
960	052	244	338	11.0236	11.0222	11.0230	11.0210	8L	26T	
				280.000	279.965	279.986	279.934	21L	66T	
964	056	248	340	11.4173	11.4159	11.4167	11.4147	8L	26T	
				290.000	289.965	289.986	289.934	21L	66T	
968	060	252	344	11.8110	11.8096	11.8104	11.8084	8L	26T	
				300.000	299.965	299.986	299.934	21L	66T	
972	064	256	348	12.2047	12.2033	12.2041	12.2021	8L	26T	
				310.000	309.965	309.986	309.934	21L	66T	
976	068	260	352	12.5984	12.5968	12.5978	12.5955	10L	29T	
				320.000	319.960	319.984	319.927	24L	73T	
980	072	264	356	13.3858	13.3842	13.3852	13.3829	10L	29T	
				340.000	339.960	339.984	339.927	24L	73T	
984	076	268	360	14.1732	14.1716	14.1726	14.1703	10L	29T	
				360.000	359.960	359.984	359.927	24L	73T	
988	080	272	364	14.9606	14.9590	14.9600	14.9577	10L	29T	
				380.000	379.960	379.984	379.927	24L	73T	
992	084	276	368	15.7480	15.7464	15.7474	15.7451	10L	29T	
				400.000	399.960	399.984	399.927	24L	73T	
996	088	280	372	16.5354	16.5336	16.5347	16.5323	11L	31T	
				420.000	419.955	419.983	419.920	28L	80T	
1000	092	284	376	17.3228	17.3210	17.3221	17.3197	11L	31T	
				440.000	439.955	439.983	439.920	28L	80T	
1004	096	288	380	18.1102	18.1084	18.1095	18.1071	11L	31T	
				460.000	459.955	459.983	459.920	28L	80T	
1008	100	292	384	18.8976	18.8958	18.8969	18.8945	11L	31T	
				480.000	479.955	479.983	479.920	28L	80T	
1012	104	296	388	19.6850	19.6832	19.6843	19.6819	11L	31T	
				500.000	499.955	499.983	499.920	28L	80T	

Outer Ring HEAVY PRESS Fit

“A” Style Bearing with Oversize O.D. For Heavy Press Fit — Use with Press Fit Inner Ring

Basic Bearing Number				Bearing Outside Diameter		Housing Bore		Resultant Fit		ABMA Fit Class
1900	1000	1200 5200	1300 7300 5300	Inch/mm				.0001 Inch/Micrometers		
				Maximum	Minimum	Maximum	Minimum	Tight	Tight	
		204		1.8514 47.026	1.8510 47.015	1.8510 47.014	1.8500 46.989	.5L 1T	14T 37T	
		205	304	2.0482 52.024	2.0477 52.011	2.0479 52.018	2.0467 51.988	2L 7L	15T 36T	
	006			2.1665 55.029	2.1660 55.016	2.1661 55.018	2.1649 54.988	1L 2L	16T 41T	
	007	206	305	2.4421 62.029	2.4416 62.016	2.4416 62.018	2.4404 61.988	0L 2L	17T 41T	
	008			2.6785 68.034	2.6780 68.021	2.6779 68.018	2.6767 67.988	1T 3T	18T 46T	
		207	306	2.8359 72.032	2.8354 72.019	2.8353 72.018	2.8341 71.988	1T 1T	18T 44T	
	009			2.9542 75.037	2.9537 75.024	2.9535 75.018	2.9523 74.988	2T 6T	19T 49T	
911	010	208	307	3.1510 80.035	3.1505 80.022	3.1503 80.018	3.1491 79.988	2T 4T	19T 47T	
912		209		3.3480 85.039	3.3474 85.024	3.3474 85.022	3.3460 84.987	0T 2T	20T 52T	
913	011	210	308	3.5449 90.040	3.5443 90.025	3.5442 90.022	3.5428 89.987	1T 3T	21T 53T	
	012			3.7419 95.044	3.7413 95.029	3.7411 95.022	3.7397 94.987	2T 7T	22T 57T	
914	013	211	309	3.9388 100.046	3.9382 100.031	3.9379 100.022	3.9365 99.987	3T 9T	23T 59T	
915				4.1358 105.049	4.1352 105.034	4.1348 105.022	4.1334 104.987	4T 12T	24T 62T	
916	014	212	310	4.3329 110.056	4.3323 110.041	4.3316 110.022	4.3302 109.987	7T 19T	27T 69T	
	015			4.5298 115.057	4.5292 115.042	4.5285 115.022	4.5271 114.987	7T 20T	27T 70T	
917		213	311	4.7266 120.056	4.7260 120.041	4.7253 120.022	4.7239 119.987	7T 19T	27T 69T	
918	016	214		4.9236 125.059	4.9229 125.041	4.9223 125.026	4.9207 124.986	6T 15T	29T 73T	
919	017	215	312	5.1204 130.058	5.1197 130.040	5.1191 130.026	5.1175 129.986	6T 14T	29T 72T	
920	018	216	313	5.5141 140.058	5.5134 140.040	5.5128 140.026	5.5112 139.986	6T 14T	29T 72T	
921	019			5.7113 145.067	5.7106 145.049	5.7097 145.026	5.7081 144.986	9T 23T	32T 81T	
922	020	217	314	5.9081 150.066	5.9074 150.048	5.9065 150.026	5.9049 149.986	9T 22T	32T 80T	
	021	218	315	6.3020 160.071	6.3010 160.046	6.3002 160.026	6.2986 159.986	8T 20T	34T 85T	
924				6.4989 165.072	6.4979 165.047	6.4971 165.026	6.4955 164.986	8T 21T	34T 86T	
	022	219	316	6.6957 170.071	6.6947 170.046	6.6939 170.026	6.6923 169.986	8T 20T	34T 85T	

Outer Ring HEAVY PRESS Fit (Cont.)

“A” Style Bearing with Oversize O.D. For Heavy Press Fit — Use with Press Fit Inner Ring

Basic Bearing Number				Bearing Outside Diameter		Housing Bore		Resultant Fit		ABMA Fit Class
1900	1000	1200 5200	1300 7300 5300	Inch/mm				.0001 Inch/Micrometers		
				Maximum	Minimum	Maximum	Minimum	Tight	Tight	
926	024	220	317	7.0894	7.0884	7.0876	7.0860	8T	34T	 NONE
				180.071	180.046	180.026	179.986	20T	85T	
928	026	222	319	7.4833	7.4821	7.4815	7.4797	6T	36T	
				190.076	190.046	190.030	189.984	16T	92T	
930	028	224	320	7.8771	7.8759	7.8752	7.8734	7T	37T	
				200.078	200.048	200.030	199.984	18T	94T	
932	030	226	321	8.2709	8.2697	8.2689	8.2671	8T	38T	
				210.081	210.051	210.030	209.984	21T	97T	
934	032	228	322	8.4680	8.4668	8.4658	8.4640	10T	40T	
				215.087	215.057	215.030	214.984	27T	103T	
936	034	230	324	8.6649	8.6637	8.6626	8.6608	11T	41T	
				220.088	220.058	220.030	219.984	28T	104T	
938	036	232	326	8.8618	8.8606	8.8595	8.8577	11T	41T	
				225.090	225.060	225.030	224.984	30T	106T	
940	038	234	328	9.0587	9.0575	9.0563	9.0545	12T	42T	
				230.091	230.061	230.030	229.984	31T	107T	
944	040	236	330	9.4526	9.4514	9.4500	9.4482	14T	44T	
				240.096	240.066	240.030	239.984	36T	112T	
948	044	240	334	9.8463	9.8451	9.8437	9.8419	14T	44T	
				250.096	250.066	250.030	249.984	36T	112T	
952	048	244	338	10.2402	10.2388	10.2376	10.2356	12T	46T	
				260.101	260.066	260.036	259.984	30T	117T	
956	052	248	340	10.6339	10.6325	10.6313	10.6293	12T	46T	
				270.101	270.066	270.036	269.984	30T	117T	
960	056	252	344	11.0276	11.0262	11.0250	11.0230	12T	46T	
				280.101	280.066	280.036	279.984	30T	117T	
964	256	252	348	11.4216	11.4202	11.4187	11.4167	15T	49T	
				290.109	290.074	290.036	289.984	38T	125T	
966	258	254	350	11.8154	11.8140	11.8124	11.8104	16T	50T	
				300.111	300.076	300.036	299.984	40T	127T	
968	260	256	352	12.2091	12.2077	12.2061	12.2041	16T	50T	
				310.111	310.076	310.036	309.984	40T	127T	
970	262	258	354	12.6032	12.6016	12.5999	12.5977	17T	55T	
				320.121	320.081	320.039	319.982	42T	139T	
972	264	260	356	13.3906	13.3890	13.3873	13.3851	17T	55T	
				340.121	340.081	340.039	339.982	42T	139T	
974	266	262	358	14.1781	14.1765	14.1747	14.1725	18T	56T	
				360.124	360.084	360.039	359.982	45T	142T	
976	268	264	360	14.9655	14.9639	14.9621	14.9599	18T	56T	
				380.124	380.084	380.039	379.982	45T	142T	
978	270	266	362	15.7529	15.7513	15.7495	15.7473	18T	56T	
				400.124	400.084	400.039	399.982	45T	142T	
980	272	268	364	16.5406	16.5388	16.5371	16.5346	17T	60T	
				420.131	420.086	420.043	419.980	43T	151T	
982	274	270	366	17.3280	17.3262	17.3245	17.3220	17T	60T	
				440.131	440.086	440.043	439.980	43T	151T	
984	276	272	368	18.9029	18.9011	18.8993	18.8968	18T	61T	
				480.134	480.089	480.043	479.980	46T	154T	
986	278	274	370	19.6903	19.6885	19.6867	19.6842	18T	61T	
				500.134	500.089	500.043	499.980	46T	154T	

Shaft Diameter — Inner Ring Omitted

With Outer Ring TAP and HEAVY PRESS Fits for Rotating Shaft

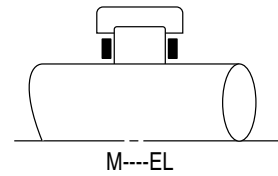
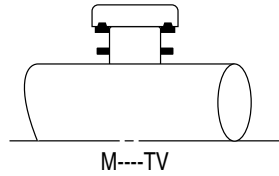

Basic Bearing Number	Shaft Diameter								Basic Bearing Number
	1900		1000		1200 5200		1300 7300 5300		
	Inch/mm								
	Maximum	Minimum	Maximum	Minimum	Maximum	Minimum	Maximum	Minimum	
04					1.1092 28.174	1.1087 28.161	1.1013 27.973	1.1008 27.960	04
05					1.2672 32.187	1.2667 32.174	1.3383 33.993	1.3378 33.980	05
06			1.4523 36.888	1.4518 36.875	1.4994 38.085	1.4989 38.072	1.6024 40.701	1.6019 40.688	06
07			1.6611 42.192	1.6606 42.179	1.7322 43.998	1.7317 43.985	1.8452 46.868	1.8447 46.855	07
08			1.8777 47.694	1.8772 47.681	1.9667 49.954	1.9662 49.941	2.0600 52.324	2.0595 52.311	08
09			2.0831 52.911	2.0825 52.896	2.1870 55.550	2.1864 55.535	2.3382 59.390	2.3376 59.375	09
10			2.2802 57.917	2.2796 57.902	2.3816 60.493	2.3810 60.478	2.5660 65.176	2.5654 65.161	10
11	2.4316 61.763	2.4310 61.748	2.5408 64.536	2.5402 64.521	2.6354 66.939	2.6348 66.924	2.8136 71.465	2.8130 71.450	11
12	2.6316 66.843	2.6310 66.828	2.7377 69.538	2.7371 69.523	2.8511 72.418	2.8505 72.403	3.0545 77.584	3.0538 77.566	12
13	2.8267 71.798	2.8261 71.783	2.9348 74.544	2.9341 74.526	3.1677 80.460	3.1670 80.442	3.2957 83.711	3.2950 83.693	13
14	3.0719 78.026	3.0712 78.008	3.1588 80.234	3.1581 80.216	3.3392 84.816	3.3385 84.798	3.5132 89.235	3.5125 89.217	14
15	3.2669 82.979	3.2662 82.961	3.3569 85.265	3.3562 85.247	3.5063 89.060	3.5056 89.042	3.7780 95.961	3.7772 95.941	15
16	3.4619 87.932	3.4612 87.914	3.5969 91.361	3.5962 91.343	3.7532 95.331	3.7525 95.313	4.0031 101.679	4.0023 101.659	16
17	3.7274 94.676	3.7267 94.658	3.7944 96.378	3.7936 96.358	4.0182 102.062	4.0174 102.042	4.2746 108.575	4.2738 108.555	17
18	3.9225 99.632	3.9217 99.612	4.0324 102.423	4.0316 102.403	4.2235 107.277	4.2227 107.257	4.4915 114.084	4.4907 114.064	18
19	4.1174 104.582	4.1166 104.562	4.2284 107.401	4.2276 107.381	4.4714 113.574	4.4706 113.554	4.8113 122.207	4.8105 122.187	19
20	4.3330 110.058	4.3322 110.038	4.4254 112.405	4.4246 112.385	4.7663 121.064	4.7655 121.044	5.1267 130.218	5.1258 130.195	20

NOTE: Shaft surface functioning as a bearing raceway must have a hardness of Rockwell C-58-64 and a maximum finish of 18 AA Deviation from this hardness or surface finish will require a reduction in the catalog load rating of the bearing. Consult NTN Engineering Department for a recommendation.

Shaft Diameter — Inner Ring Omitted

With Outer Ring PRESS Fit for Stationary Shaft

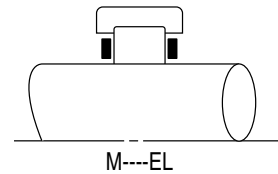
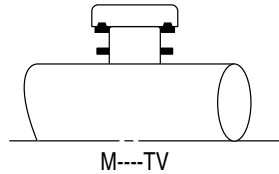

Basic Bearing Number	Shaft Diameter								Basic Bearing Number
	1900		1000		1200 5200		1300 7300 5300		
	Inch/mm								
	Maximum	Minimum	Maximum	Minimum	Maximum	Minimum	Maximum	Minimum	
04					1.1085 28.156	1.1080 28.143	1.1005 27.953	1.1000 27.940	04
05					1.2665 32.169	1.2660 32.156	1.3376 33.975	1.3371 33.962	05
06			1.4515 36.868	1.4510 36.855	1.4896 38.064	1.4981 38.051	1.6016 40.681	1.6011 40.688	06
07			1.6603 42.172	1.6598 42.159	1.7314 43.978	1.7309 43.965	1.8444 46.848	1.8439 46.835	07
08			1.8770 47.676	1.8765 47.663	1.9660 49.936	1.9655 49.923	2.0590 52.299	2.0585 52.286	08
09			2.0823 52.890	2.0817 52.875	2.1861 55.527	2.1855 55.512	2.3373 59.367	2.3367 59.352	09
10			2.2794 57.897	2.2788 57.882	2.3807 60.470	2.3801 60.455	2.5651 65.154	2.5645 65.139	10
11	2.4308 61.742	2.4302 61.727	2.5398 64.511	2.5392 64.496	2.6344 66.914	2.6338 66.899	2.8127 71.443	2.8121 71.428	11
12	2.6307 66.820	2.6301 66.805	2.7368 69.515	2.7362 69.500	2.8502 72.395	2.8496 72.380	3.0534 77.556	3.0527 77.538	12
13	2.8258 71.775	2.8252 71.760	2.9339 74.521	2.9332 74.503	3.1668 80.437	3.1661 80.419	3.2946 83.683	3.2939 83.665	13
14	3.0710 78.003	3.0703 77.985	3.1579 80.211	3.1572 80.193	3.3381 84.788	3.3374 84.770	3.5120 89.205	3.5113 89.187	14
15	3.2660 82.956	3.2653 82.938	3.3560 85.242	3.3553 85.224	3.5052 89.032	3.5045 89.014	3.7769 95.933	3.7761 95.913	15
16	3.4610 87.909	3.4603 87.891	3.5958 91.333	3.5951 91.315	3.7520 95.301	3.7513 95.283	4.0020 101.651	4.0012 101.631	16
17	3.7265 94.653	3.7258 94.635	3.7933 96.350	3.7925 96.330	4.0171 102.034	4.0163 102.014	4.2735 108.547	4.2727 108.527	17
18	3.9214 99.604	3.9206 99.584	4.0313 102.395	4.0305 102.375	4.2224 107.249	4.2216 107.229	4.4902 114.051	4.4894 114.031	18
19	4.1163 104.554	4.1155 104.534	4.2273 107.373	4.2265 107.353	4.4703 113.546	4.4695 113.526	4.8099 122.171	4.8091 122.151	19
20	4.3319 110.030	4.3311 110.010	4.4243 112.377	4.4235 112.357	4.7652 121.036	4.7644 121.016	5.1254 130.162	5.1245 130.162	20

NOTE: Shaft surface functioning as a bearing raceway must have a hardness of Rockwell C-58-64 and a maximum finish of 18 AA Deviation from this hardness or surface finish will require a reduction in the catalog load rating of the bearing. Consult NTN Engineering Department for a recommendation.

Housing Bore — Outer Ring Omitted
With Inner Ring TAP Fit for Stationary Shaft

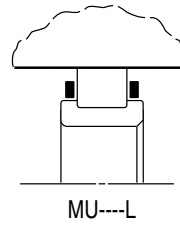
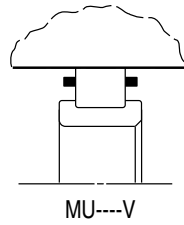

Basic Bearing Number	Shaft Diameter								Basic Bearing Number
	1900		1000		1200 5200		1300 7300 5300		
	Inch/mm								
	Maximum	Minimum	Maximum	Minimum	Maximum	Minimum	Maximum	Minimum	
04					1.6075 40.831	1.6070 40.818	1.7305 43.955	1.7300 43.942	04
05					1.7656 44.847	1.7651 44.834	2.1031 53.419	2.1026 53.406	05
06			1.9090 48.489	1.9085 48.476	2.1285 54.064	2.1280 54.051	2.3780 60.401	2.3775 60.388	06
07			2.1594 54.849	2.1589 54.836	2.4591 62.461	2.4586 62.448	2.6745 67.933	2.6740 67.920	07
08			2.3760 60.351	2.3755 60.338	2.7405 69.609	2.7400 69.596	3.0572 77.653	3.0567 77.640	08
09			2.6430 67.132	2.6424 67.117	2.9517 74.973	2.9511 74.958	3.3894 86.091	3.3888 86.076	09
10			2.8400 72.136	2.8394 72.121	3.1311 79.530	3.1305 79.515	3.7195 94.475	3.7189 94.460	10
11	2.8881 73.357	2.8875 73.342	3.1697 80.510	3.1691 80.495	3.4646 88.001	3.4640 87.986	4.0784 103.591	4.0778 103.567	11
12	3.0882 78.440	3.0876 78.425	3.3668 85.516	3.3662 85.501	3.8481 97.741	3.8475 97.726	4.4280 112.471	4.4273 112.453	12
13	3.2832 83.393	3.2826 83.378	3.5639 90.523	3.5632 90.505	4.1649 105.789	4.1642 105.771	4.7775 121.349	4.7768 121.331	13
14	3.6316 92.243	3.6309 92.225	3.9323 99.881	3.9316 99.863	4.3902 111.511	4.3895 111.493	5.0926 129.352	5.0919 129.334	14
15	3.8266 97.196	3.8259 97.178	4.1304 104.912	4.1297 104.894	4.5573 115.756	4.5566 115.738	5.4770 139.115	5.4762 139.095	15
16	4.0217 102.151	4.0210 102.133	4.4511 113.058	4.4504 113.040	4.9068 124.633	4.9061 124.615	5.8033 147.404	5.8025 147.384	16
17	4.3561 110.645	4.3554 110.627	4.6515 118.148	4.6507 118.128	5.2829 134.185	5.2821 134.165	6.1966 157.393	6.1958 157.373	17
18	4.5512 115.600	4.5504 115.580	5.0292 127.741	5.0284 127.721	5.5968 142.158	5.5960 142.138	6.5109 165.377	6.5101 165.357	18
19	4.7463 120.556	4.7455 120.536	5.2253 132.722	5.2245 132.702	5.9532 151.211	5.9524 151.191	6.8308 173.502	6.8300 173.482	19
20	5.1064 129.702	5.1056 129.682	5.4223 137.726	5.4215 137.706	6.3459 161.186	6.3451 161.166	7.2787 184.879	7.2778 184.856	20

NOTE: Shaft surface functioning as a bearing raceway must have a hardness of Rockwell C-58-64 and a maximum finish of 18 AA Deviation from this hardness or surface finish will require a reduction in the catalog load rating of the bearing. Consult NTN Engineering Department for a recommendation.

Housing Bore — Outer Ring Omitted

With Inner Ring PRESS Fit for Rotating Shaft

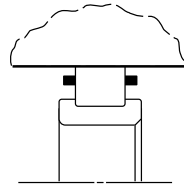

MU---V

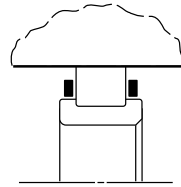

MU---L

Basic Bearing Number	Shaft Diameter								Basic Bearing Number
	1900		1000		1200 5200		1300 7300 5300		
	Inch/mm								
	Maximum	Minimum	Maximum	Minimum	Maximum	Minimum	Maximum	Minimum	
04					1.6080 40.843	1.6075 40.830	1.7309 43.965	1.7304 43.952	04
05					1.7661 44.859	1.7656 44.846	2.1036 53.432	2.1031 53.419	05
06			1.9096 48.504	1.9091 48.491	2.1291 54.079	2.1286 54.066	2.3785 60.414	2.3780 60.401	06
07			2.1600 54.864	2.1595 54.851	2.4597 62.477	2.4592 62.464	2.6751 67.948	2.6746 67.935	07
08			2.3767 60.368	2.3762 60.355	2.7411 69.624	2.7406 69.611	3.0578 77.668	3.0573 77.655	08
09			2.6438 67.152	2.6432 67.137	2.9526 74.996	2.9520 74.981	3.3902 86.111	3.3896 86.096	09
10			2.8409 72.159	2.8403 72.144	3.1319 79.550	3.1313 79.535	3.7203 94.498	3.7197 94.480	10
11	2.8892 73.385	2.8886 73.370	3.1707 80.536	3.1701 80.521	3.4656 88.026	3.4650 88.011	4.0793 103.614	4.0787 103.599	11
12	3.0893 78.468	3.0887 78.453	3.3678 85.542	3.3672 85.527	3.8491 97.767	3.8485 97.752	4.4289 112.494	4.4282 112.476	12
13	3.2843 83.421	3.2837 83.406	3.5649 90.549	3.5642 90.531	4.1658 105.812	4.1651 105.794	4.7785 121.374	4.7778 121.356	13
14	3.6329 92.276	3.6322 92.258	3.9337 99.916	3.9330 99.898	4.3914 111.544	4.3908 111.526	5.0938 129.383	5.0931 129.365	14
15	3.8280 97.231	3.8273 97.213	4.1317 104.945	4.1310 104.927	4.5585 115.786	4.5578 115.768	5.4782 139.146	5.4774 139.126	15
16	4.0230 102.184	4.0223 102.166			4.9081 124.666	4.9074 124.648	5.8045 147.434	5.8037 147.414	16
17	4.3578 110.688	4.3571 110.670			5.2845 134.226	5.2837 134.206	6.1981 157.431	6.1973 157.411	17
18	4.5529 115.643	4.5521 115.623	5.0309 127.785	5.0301 127.765	5.5984 142.199	5.5976 142.179	6.5124 165.415	6.5116 165.395	18
19	4.7480 120.599	4.7472 120.579	5.2269 132.763	5.2261 132.743	5.9548 151.252	5.9540 151.232	6.8322 173.538	6.8314 173.518	19
20	5.1082 129.748	5.1074 129.728	5.4240 137.769	5.4232 137.749	6.3474 161.224	6.3466 161.204	7.2802 184.917	7.2793 184.894	20

NOTE: Shaft surface functioning as a bearing raceway must have a hardness of Rockwell C-58-64 and a maximum finish of 18 AA Deviation from this hardness or surface finish will require a reduction in the catalog load rating of the bearing. Consult NTN Engineering Department for a recommendation.