



ISOSTATIC™

LEADERS IN BRONZE and TU BEARINGS

Powdered Metal Bronze - SAE 841 - Inch & Metric

Cast Bronze - SAE 660

TU-Steel Backed PTFE Lined - Inch & Metric

Powdered Metal Iron - SAE 863 - Inch

Special Order Products



Telephone: 800 621-5500

www.isostatic.com

INDEX

Page Nos.

Oilube Design Parameters for Bearings

Shaft Selection	3
Bearing Wall Thickness	3
Bearing Length	3
Loads, Speeds and PV	3
Tolerances	4
Calculating Bearing Dimensions and Installed Clearance	5
Stock Size Usage	6
Bearing Clearance	6
Press Fit values	6
I.D. Close-In	6
Lubrication	7
Custom Made Bearings	7
Material Specifications	7

Oilube Powdered Metal Bearings (SAE841)

Sleeve Bearings	8-24
Flange Bearings	25-29
Thrust Bearings (Washers)	30-32
Bar Stock	33
Circular Bearing Plates (Discs)	34
Rectangular Plate Stock	34
Super Oilube Bar Stock - SAE863 (78-82% iron)	34

Oilube Powdered Metal Bearings (SAE841)

Tolerances	35
Sleeve Bearings	36-38
Flange Bearings	39-40

Century Cast Bronze Bearings (SAE660)

Special Sizes and Alloys	41
Grooving and Graphiting	41
Material Specs., Tolerances, Shaft Clearances, Press Fit	42
Sleeve Bearings	43-48

Century Cast Bronze Bars

49-50

TU Steel-Backed PTFE Lined Bearings

Design Parameters - Self-Lubricating	51
Service Life Estimate	52-53
TU - Sleeve, Flange Bearings - Inch Sizes	54-55
TU - Sleeve, Flange Bearings - Metric Sizes	56-57
TU - Thrust Washers - Inch / Metric Sizes	58

TP Lead-Free Steel-Backed PTFE Lined Bearings

TP - Sleeve, Flange, Thrust Washers - Inch / Metric Sizes	59
---	----

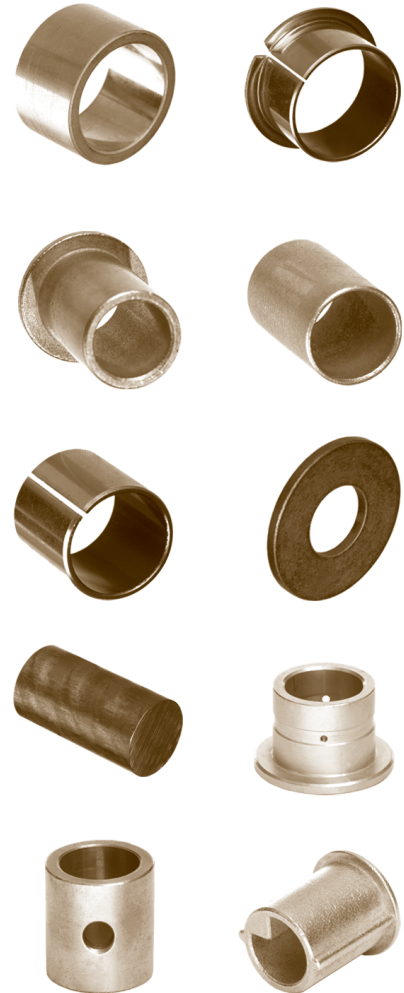
**Single Source Supply**

Our firm stocks the largest inventory of standard sizes in the U.S. This one source supply eliminates "shopping" for your part. Stock bearings are made with the highest quality powdered metals, and meet the requirements of S.A.E. specifications.

LOCATION

DESIGN PARAMETERS FOR OILUBE BEARINGS

The following information will aid you in the proper selection of bearings to meet your needs. The sample problems will illustrate the design criteria which must be established in order to select the proper bearing. Should any questions arise, our staff is ready to assist you.

Sample Problem: Design a bearing for 180 pound load at a speed of 1100 RPM

SHAFT SELECTION

Size Shaft size will be determined by the size and construction of the unit being designed. Refer to our PV Chart (page 5) in order to determine approximate criteria.

Example: A 1.000 shaft is chosen. The PV chart shows that a 1.000 shaft operating at 1100 RPM will carry 175 pounds per sq. inch load.

$$8\sqrt{\quad} \quad \text{or} \quad 16\sqrt{\quad}$$

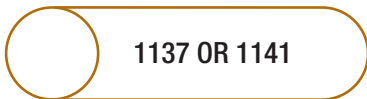

Materials Steels containing approximately 0.4% carbon are recommended, and any steels with a lower content should be avoided. The 1137-1141 series, for example, are effective grades for shaft material. In addition, drill rod and hardened and ground steels can be used.

Hard chromium plated materials are recommended when corrosion resistance is required. The performance of stainless steel materials does not equal that of straight carbon-alloy steels. If stainless steel must be used, the 300 series should be avoided. The 400 series is a good choice in stainless, and 416 stainless, heat-treated to maximum hardness, is the best.

Zinc or cadmium plating on shafts must be avoided as they are too soft and will ball up, resulting in a loss of bearing porosity, and lubrication.

Finishes Shaft finish is critical to long bearing life. Recommended finish is 16 RMS to 8 RMS. In some cases, a 32 RMS finish may be adequate if the application is not too precise.

BEARING WALL THICKNESS



For bearings less than 1/4 inch ID, the minimum wall thickness is 11/32 inch. For bearings 1/4 inch ID and larger, use the following formula to determine wall thickness:

Example:
 Wall thickness = .125 x Shaft dia.
 1" shaft
 Wall thickness = .125 x 1000
 Wall thickness = .125

Larger bearings with extremely thin walls are more costly to produce and result in increased unit costs.

BEARING LENGTH

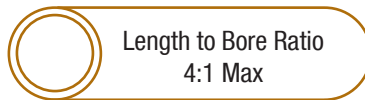

Maximum length is determined by using a ratio of length to bore, not to exceed 4:1. For diameters less than 1/4 inch, use a smaller ratio.

To determine proper bearing length, refer to the PV chart (page 5). It will give the unit load per square for a specific speed and shaft size. By dividing the unit load per square inch

into the total load to be carried by the bearing, the minimum length is found. In addition we recommend that a safety margin be used. By adding extra length, the bearing avoids operating at extreme limits.

Example: 180 lb. load
 1100 RPM
 1.000 Bearing ID
 PV chart indicates
 175 PSI UNIT LOAD

$180 \div 175 = 1.029$ Minimum length

1.029	(Minimum Length)
.221	(Safety margin)
1.250	Suggested length

LOADS and SPEEDS

Load and speed limitations must be ascertained in order to insure proper bearing design. If design limits are exceeded, the bearing life will decrease and could result in premature failure. To determine the capacity of a bearing, use the following PV formula:

- (P = The load per square inch of (Projected area)
- V = Shaft velocity in feet per minute
- (P = $\frac{\text{load}}{\text{I.D.} \times \text{Length}}$)
- V = R.P.M. x shaft diameter x .262
- (PV = (P X V)
- 1 The maximum P is 2000 P.S.I.
- 2 The maximum V is 1200 S.F.M.
- 3 The maximum PV for Oilube is 50,000

Example: 180 lb. load
 1100 RPM
 1.000 I.D. x 1.250

(P = $\frac{180}{1.000 \times 1.250}$)

(P = 144 WITHIN LIMIT
 V = 1100 x 1.00 x .262
 V = 288 SFM WITHIN LIMIT
 (PV = 144 X 288
 (PV = 41472 WITHIN LIMIT

LOAD and SPEED ("PV") CHART Based on Continuous Rotation

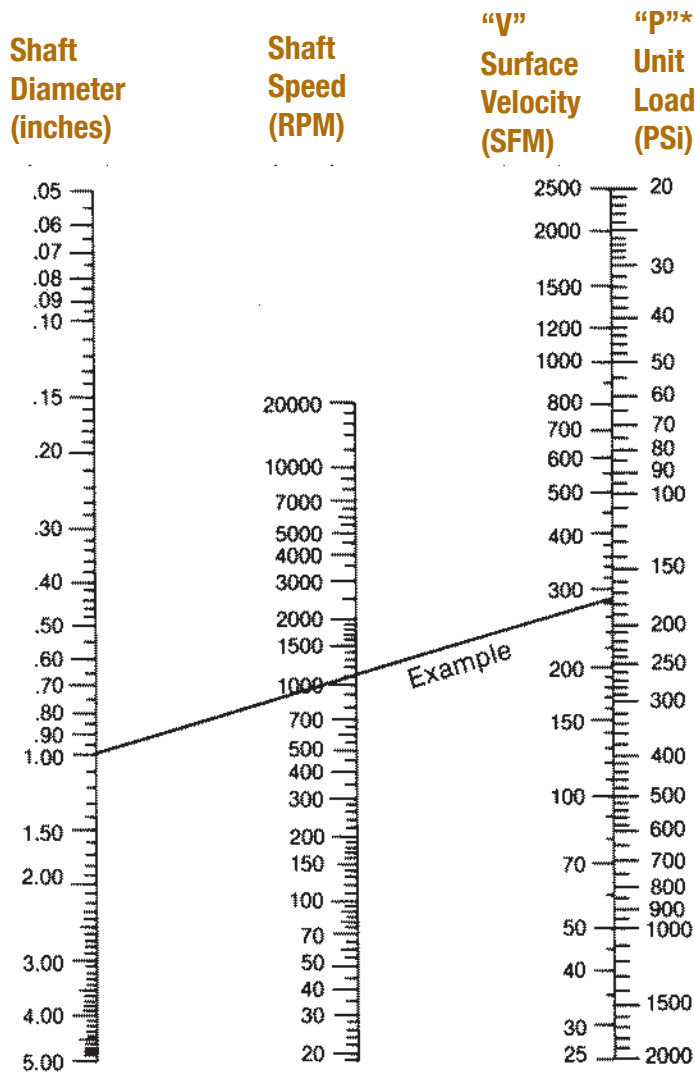

Connect two known values with a straight edge to determine the third value.

Max P = 2000
Max V = 1200

TOLERANCES

Based on ASTM Specifications

SLEEVE and FLANGE BEARING

I.D. or D.D. Size:

Up to 1-1/2"	+ .000	- .001
1-1/2" to 2-1/2"	+ .000	- .0015
2-1/2" to 3"	+ .000	- .002
3" to 4"	+ .000	- .003
4" to 5"	+ .000	- .004
5" to 6"	+ .000	- .005

Length

Up to 1-1/2"	± .005
1-1/2" to 3"	± .0075
3" to 5"	± .010

Flange Diameter

Up to 1-1/2"	± .005
1-1/2" to 3"	± .010
3" to 6"	± .025

Flange thickness:

Based on Flange O.D.

Up to 1-1/2"	± .005
1-1/2" to 3"	± .010
3" to 6"	± .015

Concentricity

Up to 1-1/2"	.003
1-1/2" to 2"	.004
2" to 4"	.006
4" to 5"	.006

THRUST BEARING (WASHERS)

Inside Diameter

Up to 1-1/4"	± .005
1-1/4" to 2-1/2"	± .010
2-1/2" to 4"	± .015
4" to 6"	± .020

Outside Diameter

Up to 1-1/2"	± .010
1-1/2" to 3"	± .015
3" to 4-1/2"	± .020
4-1/2" to 6"	± .025

Thickness ± .0025

Parallelism of Faces Based on D.D.

Up to 1-1/2"	.002
1-1/2" to 3-1/2"	.003
3-1/2" to 6"	.004



EXAMPLE and WORKSHEET for CALCULATING BEARING DIMENSIONS

Fill in the blanks (.)

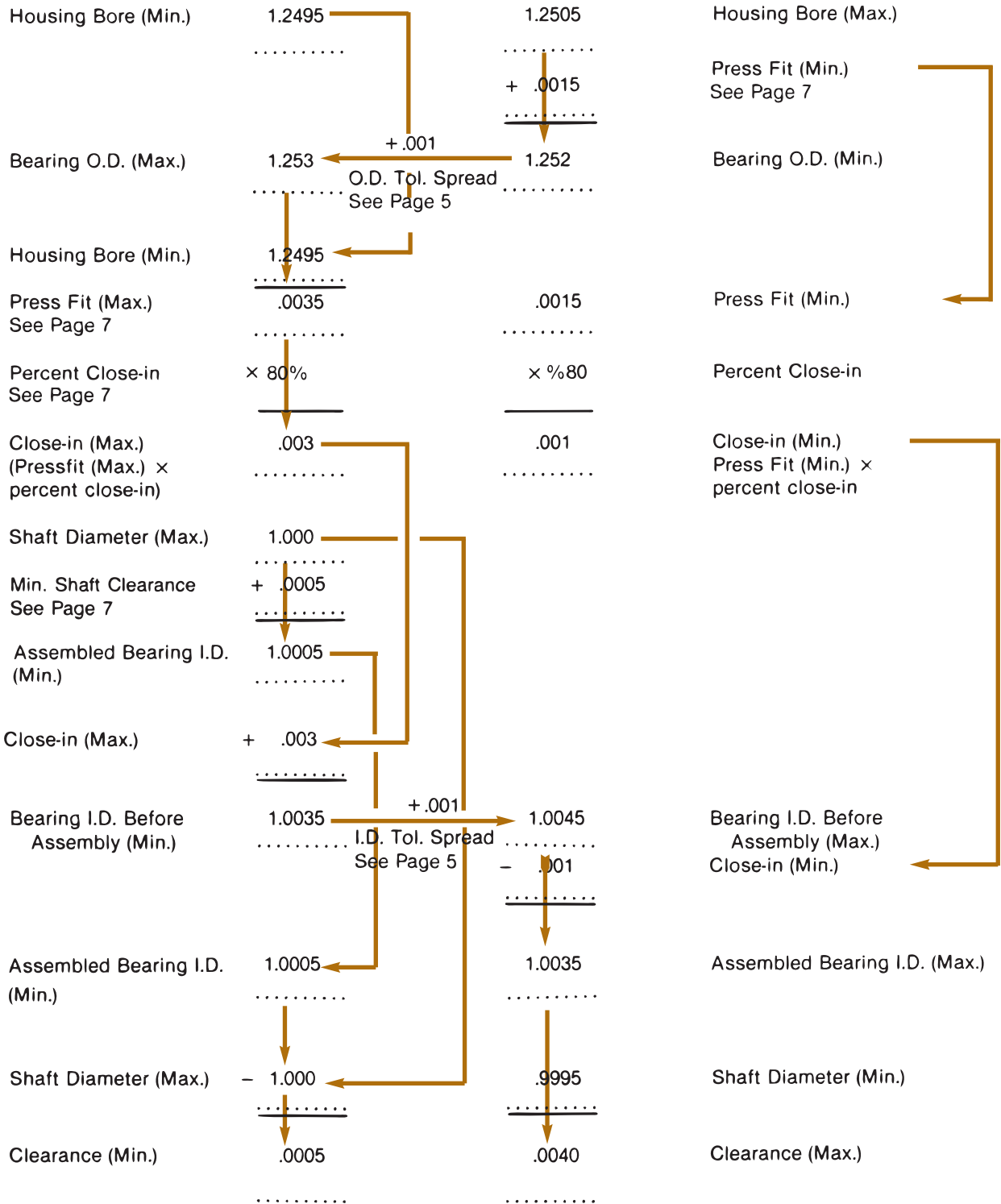

Check for Stock Size Usage (see next page)

CHECK for STOCK SIZE USAGE

From the calculations on the work sheet we have determined that the ideal dimensions should be

$$\frac{1.0035}{1.0045} \times \frac{1.252}{1.253} \times 1-1/4$$

The stock list shows a size of

$$\frac{1.004}{1.005} \times \frac{1.2515}{1.2525} \times 1-1/4 \text{ (AA1204-2)}$$

A check can be made to see if this standard size can be used.

Bearing O.D.	1.2525	1.2515
Housing Bore	- 1.2495	- 1.2505
Press Fits	.0030	.0010
Close in factor	× .8	× .8
Close in (to nearest .0005)	.0025	.0010 *
Bearing I.D.	1.0050	1.0040
Close-in	- .0010	- .0025
I.D. after assembly	1.0040	1.0015
Shaft diameter	- .9995	- 1.0000
Bearing Clearance	.0045	.0015

* Press fit deviation of .0005 is acceptable.

By using a standard size, tool costs are reduced and parts are in ready supply.

OILUBE PRESS FIT VALVES

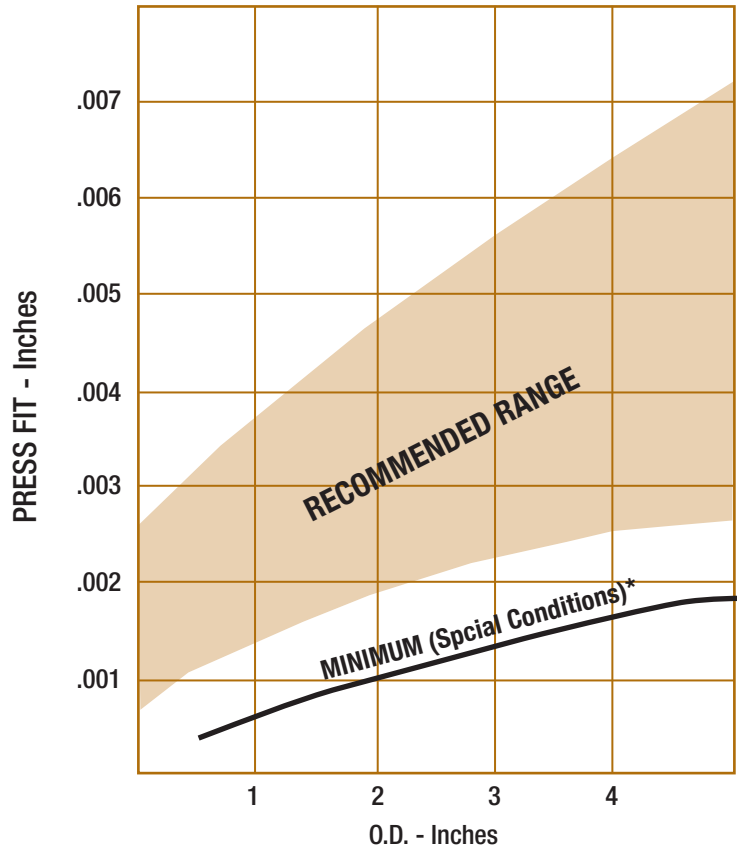

Considerable force is required to seat large bearing when press fit approaches the top of the recommended range.

- * Less than normal press fit proves satisfactory,
 (1) if the bearing is long and the wall is not exceptionally thin, and
 (2) if the bearing is also carrying a moderate load exerted only in one direction.

BEARING CLEARANCE OILUBE BEARINGS

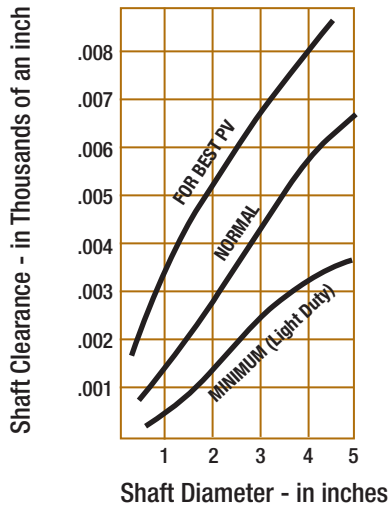

BEARING CLEARANCE OILUBE BEARINGS

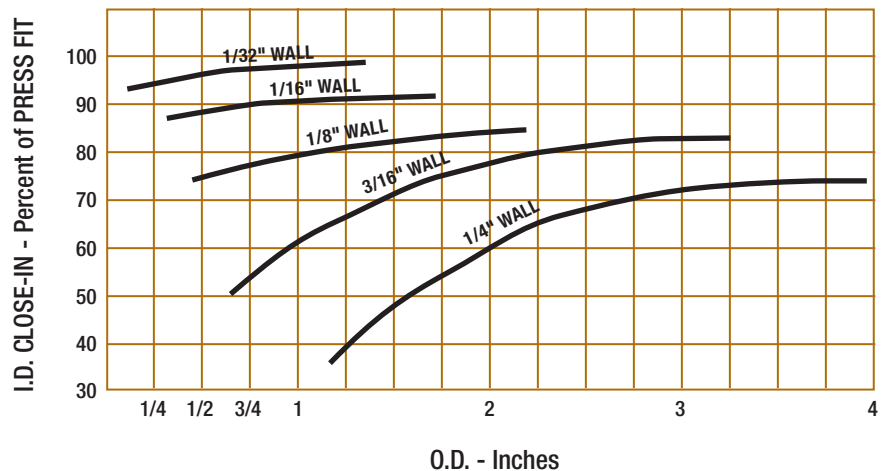

LUBRICATION

Proper lubrication is essential for the Oilube bearing, and we use the highest quality oils available. Our standard lubricant has an effective operating range from +10°F to + 175° *F. Applications requiring extended or unusual operating ranges must be identified so that we can select a special lubricant to do the job. This impregnation process is available for a minimal charge.

Supplementary Lubrication Additional lubrication can be provided thru the use of oil soaked felts, wicks, etc., or by periodic oiling. A unique advantage of the Oilube bearing is that it does not require any grooving or holes to distribute the oil across the bearing surfaces. The Oilube bearing distributes oil evenly across the bearing face due to the microscopic pores in the material.

Storage of Bearings Oilube bearings must be stored in non-absorbing containers. Do not store in paper or cloth containers. Do not store in cardboard boxes! The best containers are made of plastic or metal.

De-Oiling To remove oil from a bearing, immerse it in a solvent for 12 hours. An aromatic solvent is recommended. Chlorinated solvents should be avoided, as they can initiate corrosion within the pores of the material. After soaking in solvent, the bearings should air dry until the absorbed solvent is evaporated.

Re-Oiling The most efficient method of impregnation is by the vacuum

process. However, this process is typically available only to bearing manufacturers. Re-oiling can also be accomplished by immersing the bearings in oil heated to 150-175°F. This method will result in a 90% saturation of the bearing material. The graph above indicates the length of time required to achieve maximum impregnation by both methods.

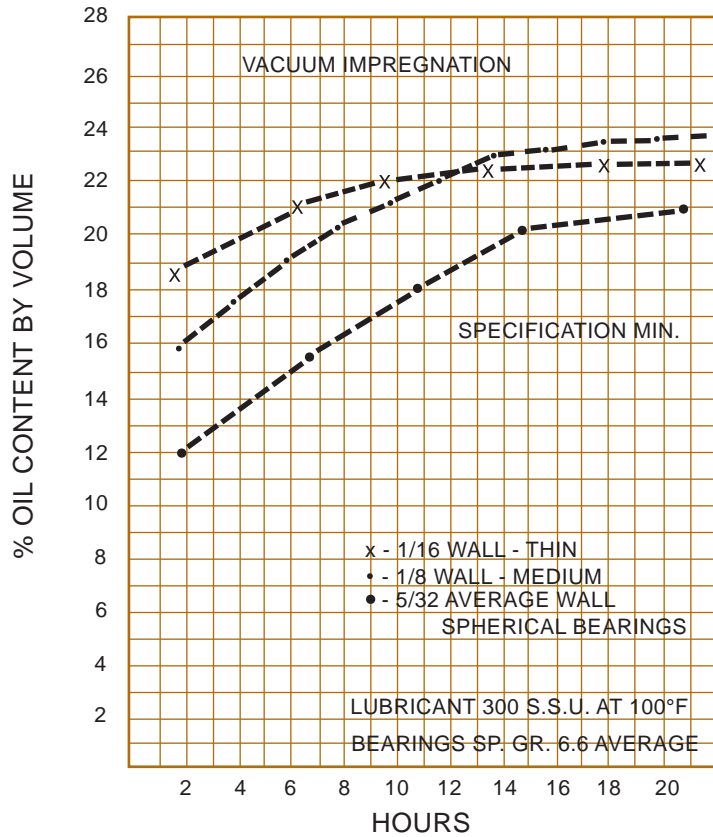

Immersion versus vacuum impregnation for bearing lubrication.

CUSTOM MADE BEARINGS

Custom bearings can be designed and manufactured according to customer specifications, including requirements for special dimensions and/or materials. Our inventory provides for a large supply of nearly all the powdered metal mixes used in bearing manufacture. Please give us a call and tell us about your special needs.

OILUBE MATERIAL SPECIFICATIONS

Composition %	Density (gm/cc)	Porosity (% by Vol.)	K Strength Constant	Tensile Strength	Elongation (in 1")	Yield Strength PSI	Comparable Specifications	Formally
Copper 87.5 - 90.5 Tin 9.5 - 10.5 Iron 1.0 max. Carbon 1.75 Other Elements 0.5	6.4 - 6.8	19 min.	26500	14000	1	11000	ASTM B-438-70, Grade 1, Type 2 MPIF CT-1000-K26 SAE 841 Military - Brgs ASTM-B-438	---- CT-0010-R ---- Mil-B-5687D Type 1Gr 1

SUPER OILUBE MATERIAL SPECIFICATIONS

Copper 18.0 - 22.0 Iron Balance Other Elements 2.0	5.8 - 6.2	19 min.	40000	22000	1	22000	ASTM B-439-70, Grade 4 FC-2000-K30 SAE 863 Military - Brgs ASTM-B-439	---- ---- Type 3 Mil-B-5687D Type 2, Graded 4
--	-----------	---------	-------	-------	---	-------	--	---



ID	OD	LGTH.	ITEM NO.	PART NO.
1/8 X 3/16 NOMINAL				
.125	.190	5/32	101001	AA-101-8
		1/4	101002	AA-101-2
		3/8	101003	AA-101
		1/2	101004	AA-101-1
.1265	.1895	1/8	101005	AA-110-1
		1/4	101006	AA-110-2
		5/16	101007	AA-110-4
.127	.1895	1/4	401001	SS-46-4
		1/2	401002	SS-46-8
.127	.1905	1/4	201001	EP020304 (P-12-2)
		1/2	201002	EP020308 (P-12-4)
1/8 X 7/32 NOMINAL				
.127	.222	1/4	101008	AA-223
		3/8	101009	AA-223-1
1/8 X 1/4 NOMINAL				
.127	.252	1/8	301001	B-24-1
		1/4	301002	B-24-2
		3/8	301003	B-24-3
		1/2	301004	B-24-4
.127	.252	1/8	401003	SS-48-2
		1/4	401004	SS-48-4
		3/8	401005	SS-48-6
		1/2	401006	SS-48-8
.127	.253	1/8	201003	EP020402 (P-13-1)
		1/4	201004	EP020404 (P-13-2)
		3/8	201005	EP020406 (P-13-3)
		1/2	201006	EP020408 (P-13-4)
.128	.253	1/4	101010	AA-224
		3/8	101011	AA-224-1
1/8 X 5/16 NOMINAL				
.127	.3145	1/4	401007	SS-410-4
		3/8	401008	SS-410-6
		1/2	401009	SS-410-8
.127	.315	1/8	301005	B-25-1
		1/4	301006	B-25-2
		3/8	301007	B-25-3
		1/2	301008	B-25-4
		5/8	301009	B-25-5
.127	.3155	1/8	201007	EP020502 (P-14-1)
		1/4	201008	EP020504 (P-14-2)
		3/8	201009	EP020506 (P-14-3)
		1/2	201010	EP020508 (P-14-4)
1/8 X 3/8 NOMINAL				
.127	.377	1/4	101012	AA-337-2
		1/2	101013	AA-337-3
5/32 X 7/32 NOMINAL				
.156	.220	1/4	101014	AA-211
		3/8	101015	AA-211-1

ID	OD	LGTH.	ITEM NO.	PART NO.
5/32 X 1/4 NOMINAL				
.1565	.2525	3/8	101016	AA-238
		1/4	101017	AA-204-1
.159	.253	1/4	101018	AA-204
		5/16	101018	AA-204
3/16 X 1/4 NOMINAL				
.1875	.252	1/4	101019	AA-225-2
		5/16	101020	AA-225-1
		3/8	101021	AA-225-6
		1/2	101022	AA-225-4
		5/8	101023	AA-225-3
.1885	.252	1/4	101024	AA-226-1
		3/8	101025	AA-226-2
		7/16	101026	AA-226
		1/2	101027	AA-226-3
		5/8	101028	AA-226-4
.189	.252	1/4	301010	B-34-2
		3/8	301011	B-34-3
		1/2	301012	B-34-4
		5/8	301013	B-34-5
		3/4	301014	B-34-6
		1/4	401010	SS-68-4
.189	.252	3/8	401011	SS-68-6
		1/2	401012	SS-68-8
		5/8	401013	SS-68-10
		3/4	401014	SS-68-12
		1/4	201011	EP030404 (P-18-2)
.1895	.253	3/8	201012	EP030406 (P-18-3)
		1/2	201013	EP030408 (P-18-4)
		5/8	201014	EP030410 (P-18-5)
		3/4	201015	EP030412 (P-18-6)
3/16 X 5/16 NOMINAL				
.1885	.3145	3/16	101029	AA-309-9
		1/4	101030	AA-309
		5/16	101031	AA-309-3
		3/8	101032	AA-309-4
		7/16	101033	AA-309-8
		1/2	101034	AA-309-14
.189	.314	5/8	101035	AA-309-7
		3/4	101036	AA-309-5
		1/4	301015	B-35-2
		3/8	301016	B-35-3
		1/2	301017	B-35-4
.1895	.3145	5/8	301018	B-35-5
		3/4	301019	B-35-6
		3/16	101037	AA-331
.1895	.3145	1/4	101038	AA-331-2
		3/8	101039	AA-331-3
.1895	.3155	3/16	201554	EP030503 (P-19-1.5)
		1/4	201016	EP030504 (P-19-2)
		5/16	201555	EP030505 (P-19-2.5)
		3/8	201017	EP030506 (P-19-3)

ID	OD	LGTH.	ITEM NO.	PART NO.
.1895	.3155	1/2	201018	EP030508 (P-19-4)
		5/8	201019	EP030510 (P-19-5)
		3/4	201020	EP030512 (P-19-6)
		1	201021	EP030516 (P-19-8)
.190	.3145	1/4	401015	SS-610-4
		3/8	401016	SS-610-6
		1/2	401017	SS-610-8
		5/8	401018	SS-610-10
		3/4	401019	SS-610-12
.1885	.3775	1/4	101040	AA-346-1
		3/8	101041	AA-346-2
		1/2	101042	AA-346
.1895	.378	1/4	201556	EP030604 (P-20-2)
		3/8	201022	EP030606 (P-20-3)
		1/2	201023	EP030608 (P-20-4)
		5/8	201024	EP030610 (P-20-5)
		3/4	201025	EP030612 (P-20-6)
.190	.377	3/8	401021	SS-612-6
		1/2	401022	SS-612-8
		5/8	401023	SS-612-10
.190	.377	3/4	401024	SS-612-12
		7/32 X 5/16 NOMINAL		
.219	.3145	5/16	101043	AA-318
		3/8	101044	AA-318-1
7/32 X 7/16 NOMINAL				
.219	.440	1/2	101045	AA-410-2
		3/4	101046	AA-410-3
1/4 X 5/16 NOMINAL				
.2505	.3145	1/4	101047	AA-397-1
		1/2	101048	AA-397
.2515	.3155	1/4	101049	AA-347-2
		3/8	101050	AA-347-3
.252	.315	1/2	301455	B-45-4
		1/4	401025	SS-810-4
.252	.315	3/8	401026	SS-810-6
		1/2	401027	SS-810-8
		3/4	401028	SS-810-12
		1/4	201026	EP040504 (P-25-2)
.252	.3155	3/8	201027	EP040506 (P-25-3)
		1/2	201028	EP040508 (P-25-4)
		5/8	201557	EP040510 (P-25-5)
		3/4	201029	EP040512 (P-25-6)
.253	.3155	1/2	101051	AA-335-4
		5/8	101052	AA-335-6
		3/4	101053	AA-335-5
		1/4 X 3/8 NOMINAL		
.2505	.377	1/4	101054	AA-304-35

*Other sizes, tolerances, lubricants and materials are available on special orders.



ID	OD	LGTH.	ITEM NO.	PART NO.
1/4 X 3/8 NOMINAL (cont.)				
.2505	.377	5/16	101055	AA-304-9
		3/8	101056	AA-304-7
		7/16	101057	AA-304-24
		1/2	101058	AA-304-2
		9/16	101059	AA-304-5
		5/8	101060	AA-304-1
		3/4	101061	AA-304-22
		7/8	101062	AA-304-21
		1	101063	AA-304-20
		1-1/8	101064	AA-304-33
		1-1/4	101065	AA-304-11
.252	.377	1/4	101066	AA-307
		5/16	101067	AA-307-1
		3/8	101068	AA-307-9
		1/2	101069	AA-307-3
		5/8	101070	AA-307-10
		3/4	101071	AA-307-11
		1	101072	AA-307-2
		1-1/8	101073	AA-307-13
.252	.377	1/4	301020	B-46-2
		5/16	301021	B-46-2-1/2
		3/8	301022	B-46-3
		1/2	301023	B-46-4
		5/8	301024	B-46-5
		3/4	301025	B-46-6
		7/8	301026	B-46-7
		1	301027	B-46-8
		1-1/4	301028	B-46-10
.252	.377	1/4	401029	SS-812-4
		3/8	401030	SS-812-6
		1/2	401031	SS-812-8
		5/8	401032	SS-812-10
		3/4	401033	SS-812-12
		7/8	401034	SS-812-14
		1	401035	SS-812-16
		1-1/4	401036	SS-812-20
.252	.378	1/4	201030	EP040604 (P-26-2)
		5/16	201558	EP040605 (P-26-2.5)
		3/8	201031	EP040606 (P-26-3)
		7/16	201559	EP040607 (P-26-3.5)
		1/2	201032	EP040608 (P-26-4)
		5/8	201033	EP040610 (P-26-5)
		3/4	201034	EP040612 (P-26-6)
		7/8	201035	EP040614 (P-26-7)
		1	201036	EP040616 (P-26-8)
		1-1/8	201037	EP040618 (P-26-9)
		1-1/4	201038	EP040620 (P-26-10)
.253	.377	1/4	101074	AA-385-1
		1/2	101075	AA-385
		3/4	101076	AA-385-2
1/4 X 7/16 NOMINAL				
.251	.4395	3/8	101077	AA-430

ID	OD	LGTH.	ITEM NO.	PART NO.
.251	.4395	1/2	101078	AA-430-1
		5/8	101079	AA-430-5
		3/4	101080	AA-430-2
		7/8	101081	AA-430-6
		1	101082	AA-430-3
.252	.439	3/8	301029	B-47-3
		1/2	301030	B-47-4
		5/8	301031	B-47-5
		3/4	301032	B-47-6
		7/8	301033	B-47-7
		1	301034	B-47-8
.252	.439	3/8	401037	SS-814-6
		1/2	401038	SS-814-8
		5/8	401039	SS-814-10
		3/4	401040	SS-814-12
		7/8	401041	SS-814-14
		1	401042	SS-814-16
.252	.4395	3/8	101083	AA-412-10
		1/2	101084	AA-412-7
		5/8	101085	AA-412-6
		3/4	101086	AA-412-1
		1	101087	AA-412-8
.252	.4405	3/8	201039	EP040706 (P-27-3)
		1/2	201040	EP040708 (P-27-4)
		5/8	201041	EP040710 (P-27-5)
		3/4	201042	EP040712 (P-27-6)
		7/8	201043	EP040714 (P-27-7)
		1	201044	EP040716 (P-27-8)
1/4 X 1/2 NOMINAL				
.252	.5015	5/16	101088	AA-519-4
		1/2	101089	AA-519-1
		3/4	101090	AA-519-2
		1	101091	AA-519-3
.252	.502	3/8	301035	B-48-3
		1/2	301036	B-48-4
		5/8	301037	B-48-5
		3/4	301038	B-48-6
		7/8	301039	B-48-7
		1	301040	B-48-8
		1-1/4	301041	B-48-10
.252	.503	5/16	201560	EP040805 (P-28-2.5)
		1/2	201045	EP040808 (P-28-4)
		3/4	201046	EP040812 (P-28-6)
		1	201047	EP040816 (P-28-8)
		1-1/4	201048	EP040820 (P-28-10)
.252	.503	1/2	401043	SS-816-8
		3/4	401044	SS-816-12
		1	401045	SS-816-16
		1-1/4	401046	SS-816-20
5/16 X 3/8 NOMINAL				
.3135	.377	1/4	101092	AA-306-11
		5/16	101093	AA-306-1

ID	OD	LGTH.	ITEM NO.	PART NO.
.3135	.377	3/8	101094	AA-306-3
		1/2	101095	AA-306-7
		5/8	101096	AA-306-8
		3/4	101097	AA-306-6
.314	.377	3/8	301042	B-56-3
		1/2	301043	B-56-4
		5/8	301044	B-56-5
		3/4	301045	B-56-6
		7/8	301046	B-56-7
		1	301047	B-56-8
.3145	.378	1/4	201049	EP050604 (P-31-2)
		3/8	201050	EP050606 (P-31-3)
		1/2	201051	EP050608 (P-31-4)
		5/8	201052	EP050610 (P-31-5)
		3/4	201053	EP050612 (P-31-6)
		7/8	201054	EP050614 (P-31-7)
		1	201055	EP050616 (P-31-8)
.3145	.378	1/4	401047	SS-1012-4
		3/8	401048	SS-1012-6
		1/2	401049	SS-1012-8
		5/8	401050	SS-1012-10
		3/4	401051	SS-1012-12
		7/8	401052	SS-1012-14
		1	401053	SS-1012-16
5/16 X 7/16 NOMINAL				
.3115	.441	3/8	101098	AA-403
		1/2	101099	AA-403-2
.3125	.440	1/4	101100	AA-407-1
		5/16	101101	AA-407-10
		3/8	101102	AA-407-7
		1/2	101103	AA-407-3
		5/8	101104	AA-407-2
		3/4	101105	AA-407-4
.3135	.4395	1/4	101106	AA-401-17
		5/16	101107	AA-401-25
		3/8	101110	AA-401-2
		7/16	101108	AA-401-20
		1/2	101111	AA-401-3
		5/8	101112	AA-401-21
		11/16	101109	AA-401-11
		3/4	101113	AA-401-5
		7/8	101114	AA-401-12
		1	101115	AA-401-1
		1-1/8	101116	AA-401
		1-1/4	101117	AA-401-6
		1-3/8	101118	AA-401-8
.314	.439	1/4	301048	B-57-2
		3/8	301049	B-57-3
		1/2	301050	B-57-4
		5/8	301051	B-57-5
		3/4	301052	B-57-6
		7/8	301053	B-57-7

*Other sizes, tolerances, lubricants and materials are available on special orders.



ID	OD	LGTH.	ITEM NO.	PART NO.	ID	OD	LGTH.	ITEM NO.	PART NO.	ID	OD	LGTH.	ITEM NO.	PART NO.
5/16 X 7/16 NOMINAL (cont.)														
.314	.439	1	301054	B-57-8	.3145	.503	7/8	201069	EP050814 (P-33-7)	.377	.502	1-1/4	301072	B-68-10
		1-1/4	301055	B-57-10			1	201070	EP050816 (P-33-8)	.377	.503	3/16	201563	EP060803 (P-38-1.5)
		1-3/8	301056	B-57-11			1-1/4	201071	EP050820 (P-33-10)			1/4	201077	EP060804 (P-38-2)
.3145	.440	1/4	401054	SS-1014-4			1-1/2	201072	EP050824 (P-33-12)			5/16	201564	EP060805 (P-38-2.5)
		3/8	401055	SS-1014-6	.3145	.503	3/8	401063	SS-1016-6			3/8	201078	EP060806 (P-38-3)
		1/2	401056	SS-1014-8			1/2	401064	SS-1016-8			7/16	201565	EP060807 (P-38-3.5)
		5/8	401057	SS-1014-10			5/8	401065	SS-1016-10			1/2	201079	EP060808 (P-38-4)
		3/4	401058	SS-1014-12			3/4	401066	SS-1016-12			5/8	201080	EP060810 (P-38-5)
		7/8	401059	SS-1014-14			7/8	401067	SS-1016-14			3/4	201081	EP060812 (P-38-6)
		1	401060	SS-1014-16			1	401068	SS-1016-16			7/8	201082	EP060814 (P-38-7)
		1-1/8	401061	SS-1014-18			1-1/4	401069	SS-1016-20			1	201083	EP060816 (P-38-8)
		1-1/4	401062	SS-1014-20			1-1/2	401070	SS-1016-24			1-1/8	201084	EP060818 (P-38-9)
					3/8 X 7/16 NOMINAL									
.3145	.4405	1/4	201056	EP050704 (P-32-2)	.3765	.440	1/4	101135	AA-432-4	.378	.5025	1/4	101159	AA-502-5
		5/16	201561	EP050705 (P-32-2.5)			3/8	101136	AA-432-2			1/2	101160	AA-502
		3/8	201057	EP050706 (P-32-3)			1/2	101137	AA-432-1			5/8	101161	AA-502-3
		1/2	201058	EP050708 (P-32-4)			3/4	101138	AA-432-3			3/4	101162	AA-502-1
		5/8	201059	EP050710 (P-32-5)								1	101163	AA-502-2
		3/4	201060	EP050712 (P-32-6)	.377	.440	1/2	401071	SS-1214-8	.378	.503	1/4	401075	SS-1216-4
		7/8	201061	EP050714 (P-32-7)			5/8	401072	SS-1214-10			3/8	401076	SS-1216-6
		1	201062	EP050716 (P-32-8)			3/4	401073	SS-1214-12			1/2	401077	SS-1216-8
		1-1/8	201063	EP050718 (P-32-9)			1	401074	SS-1214-16			5/8	401078	SS-1216-10
		1-1/4	201064	EP050720 (P-32-10)								3/4	401079	SS-1216-12
.3155	.4395	1/4	101119	AA-417-7	.377	.4405	1/2	201073	EP060708 (P-37-4)			7/8	401080	SS-1216-14
		1/2	101120	AA-417			5/8	201074	EP060710 (P-37-5)			1	401081	SS-1216-16
		3/4	101121	AA-417-3			3/4	201075	EP060712 (P-37-6)			1-1/8	401082	SS-1216-18
					3/8 X 1/2 NOMINAL									
.3125	.503	3/8	101122	AA-520-8	.375	.503	1/4	101139	AA-521-4			1-1/4	401083	SS-1216-20
		1/2	101123	AA-520-3			3/8	101140	AA-521-9	3/8 X 9/16 NOMINAL				
		5/8	101124	AA-520-4			7/16	101141	AA-521-8	.3765	.5655	3/8	101164	AA-516-5
		3/4	101125	AA-520-1			1/2	101142	AA-521-1			1/2	101165	AA-516-6
		7/8	101126	AA-520-2			5/8	101143	AA-521-10			9/16	101166	AA-516-3
		1	101127	AA-520-5			3/4	101144	AA-521			11/16	101167	AA-516
.314	.502	3/8	301057	B-58-3			7/8	101145	AA-521-2			3/4	101168	AA-516-10
		1/2	301058	B-58-4			1	101146	AA-521-11			1	101169	AA-516-8
		5/8	301059	B-58-5			1-1/4	101147	AA-521-12			1-1/4	101170	AA-516-2
		3/4	301060	B-58-6	.3765	.503	3/16	101148	AA-507-12	.377	.5645	3/8	301073	B-69-3
		7/8	301061	B-58-7			1/4	101149	AA-507-19			1/2	301074	B-69-4
		1	301062	B-58-8			5/16	101150	AA-507-13			5/8	301075	B-69-5
		1-1/4	301063	B-58-10			3/8	101151	AA-507-11			3/4	301076	B-69-6
		1-1/2	301064	B-58-12			7/16	101152	AA-507-4			7/8	301077	B-69-7
		1-3/4	301065	B-58-14			1/2	101153	AA-507-10			1	301078	B-69-8
.314	.503	1/4	101128	AA-506-16			5/8	101154	AA-507-5			1-1/4	301079	B-69-10
		3/8	101129	AA-506-2			3/4	101155	AA-507-2	.377	.5655	3/8	201086	EP060906 (P-39-3)
		1/2	101130	AA-506-7			7/8	101156	AA-507-3			1/2	201087	EP060908 (P-39-4)
		9/16	101131	AA-506-1			1	101157	AA-507-23			5/8	201088	EP060910 (P-39-5)
		5/8	101132	AA-506-3			1-1/8	101158	AA-507-17			3/4	201089	EP060912 (P-39-6)
		3/4	101133	AA-506-8								7/8	201090	EP060914 (P-39-7)
		1	101134	AA-506-9	.377	.502	3/8	301066	B-68-3			1	201091	EP060916 (P-39-8)
.3145	.503	3/8	201065	EP050806 (P-33-3)			1/2	301067	B-68-4			1-1/4	201092	EP060920 (P-39-10)
		1/2	201066	EP050808 (P-33-4)			5/8	301068	B-68-5	.378	.565	3/8	401084	SS-1218-6
		5/8	201067	EP050810 (P-33-5)			3/4	301069	B-68-6			1/2	401085	SS-1218-8
		3/4	201068	EP050812 (P-33-6)			7/8	301070	B-68-7			5/8	401086	SS-1218-10
							1	301071	B-68-8					

*Other sizes, tolerances, lubricants and materials are available on special orders.



ID	OD	LGTH.	ITEM NO.	PART NO.
3/8 X 9/16 NOMINAL (cont.)				
.378	.565	3/4	401087	SS-1218-12
		7/8	401088	SS-1218-14
		1	401089	SS-1218-16
		1-1/4	401090	SS-1218-20
3/8 X 5/8 NOMINAL				
.376	.627	3/8	101171	AA-630-8
		7/16	101172	AA-630-16
		1/2	101173	AA-630-11
		5/8	101174	AA-630-6
		3/4	101175	AA-630-12
		7/8	101176	AA-630
		1	101177	AA-630-7
		1-1/8	101178	AA-630-1
		1-1/4	101179	AA-630-2
.377	.627	3/8	301080	B-610-3
		1/2	301081	B-610-4
		5/8	301082	B-610-5
		3/4	301083	B-610-6
		7/8	301084	B-610-7
		1	301085	B-610-8
		1-1/4	301086	B-610-10
.377	.628	3/8	201093	EP061006 (P-40-3)
		1/2	201094	EP061008 (P-40-4)
		5/8	201095	EP061010 (P-40-5)
		3/4	201096	EP061012 (P-40-6)
		7/8	201097	EP061014 (P-40-7)
		1	201098	EP061016 (P-40-8)
		1-1/4	201099	EP061020 (P-40-10)
.378	.628	3/8	401091	SS-1220-6
		1/2	401092	SS-1220-8
		5/8	401093	SS-1220-10
		3/4	401094	SS-1220-12
		7/8	401095	SS-1220-14
		1	401096	SS-1220-16
		1-1/4	401097	SS-1220-20
		1-1/2	401098	SS-1220-24
3/8 X 11/16 NOMINAL				
.3765	.689	3/4	101180	AA-615
		1-1/2	101181	AA-615-2
3/8 X 3/4 NOMINAL				
.377	.753	1/2	101182	AA-707-2
		3/4	101183	AA-707-3
		1	101184	AA-707
		1-1/4	101185	AA-707-4
.377	.753	3/8	301087	B-612-3
		1/2	301088	B-612-4
		3/4	301089	B-612-6
		1	301090	B-612-8
		1-1/4	301091	B-612-10
.377	.753	3/8	201100	EP061206 (P-41-3)

ID	OD	LGTH.	ITEM NO.	PART NO.
.377	.753	1/2	201101	EP061208 (P-41-4)
		3/4	201102	EP061212 (P-41-6)
		1	201103	EP061216 (P-41-8)
		1-1/4	201104	EP061220 (P-41-10)
.378	.753	3/8	401099	SS-1224-6
		1/2	401100	SS-1224-8
		3/4	401101	SS-1224-12
		1	401102	SS-1224-16
		1-1/4	401103	SS-1224-20
7/16 X 9/16 NOMINAL				
.439	.5645	3/8	301092	B-79-3
		1/2	301093	B-79-4
		5/8	301094	B-79-5
		3/4	301095	B-79-6
		7/8	301096	B-79-7
		1	301097	B-79-8
		1-1/4	301098	B-79-10
.439	.565	5/16	101186	AA-515-1
		3/8	101187	AA-515-21
		1/2	101188	AA-515-2
		5/8	101189	AA-515-3
		3/4	101190	AA-515
		13/16	101191	AA-515-12
		15/16	101192	AA-515-6
		1	101193	AA-515-8
.4395	.5655	3/8	201105	EP070906 (P-43-3)
		1/2	201106	EP070908 (P-43-4)
		5/8	201107	EP070910 (P-43-5)
		3/4	201108	EP070912 (P-43-6)
		7/8	201109	EP070914 (P-43-7)
		1	201110	EP070916 (P-43-8)
		1-1/4	201111	EP070920 (P-43-10)
.440	.565	3/8	401104	SS-1418-6
		1/2	401105	SS-1418-8
		5/8	401106	SS-1418-10
		3/4	401107	SS-1418-12
		7/8	401108	SS-1418-14
		1	401109	SS-1418-16
		1-1/4	401110	SS-1418-20
7/16 X 5/8 NOMINAL				
.439	.627	3/8	101194	AA-627-5
		7/16	101195	AA-627-13
		1/2	101196	AA-627-8
		5/8	101197	AA-627-3
		3/4	101198	AA-627
		1	101199	AA-627-4
		1-1/4	101200	AA-627-1
		1-1/2	101201	AA-627-7
.439	.628	3/8	301099	B-710-3
		1/2	301100	B-710-4
		5/8	301101	B-710-5

ID	OD	LGTH.	ITEM NO.	PART NO.
.439	.628	3/4	301102	B-710-6
		7/8	301103	B-710-7
		1	301104	B-710-8
		1-1/4	301105	B-710-10
.4395	.628	3/8	201112	EP071006 (P-44-3)
		1/2	201113	EP071008 (P-44-4)
		5/8	201114	EP071010 (P-44-5)
		3/4	201115	EP071012 (P-44-6)
		7/8	201116	EP071014 (P-44-7)
		1	201117	EP071016 (P-44-8)
		1-1/4	201118	EP071020 (P-44-10)
		1-1/2	201119	EP071024 (P-44-12)
.440	.628	3/8	401111	SS-1420-6
		1/2	401112	SS-1420-8
		5/8	401113	SS-1420-10
		3/4	401114	SS-1420-12
		7/8	401115	SS-1420-14
		1	401116	SS-1420-16
		1-1/4	401117	SS-1420-20
		1-1/2	401118	SS-1420-24
7/16 X 11/16 NOMINAL				
.439	.690	1/2	301106	B-711-4
		1	301107	B-711-8
		1-1/2	301108	B-711-12
.4395	.6905	1/2	201120	EP071108 (P-45-4)
		1	201121	EP071116 (P-45-8)
		1-1/2	201122	EP071124 (P-45-12)
.4395	.6905	1/2	401119	SS-1422-8
		1	401120	SS-1422-16
		1-1/2	401121	SS-1422-24
1/2 X 5/8 NOMINAL				
.5015	.628	5/16	101202	AA-628-21
		3/8	101203	AA-628-7
		7/16	101204	AA-628-8
		1/2	101205	AA-628-10
		9/16	101206	AA-628-3
		5/8	101207	AA-628-25
		11/16	101208	AA-628-12
		3/4	101209	AA-628-6
		7/8	101210	AA-628-20
		1	101211	AA-628
		1-1/4	101212	AA-628-11
		1-1/2	101213	AA-628-5
.502	.628	1/2	301109	B-810-4
		5/8	301110	B-810-5
		3/4	301111	B-810-6
		7/8	301112	B-810-7
		1	301113	B-810-8
		1-1/8	301114	B-810-9
		1-1/4	301115	B-810-10
		1-1/2	301116	B-810-12
.502	.628	5/16	201566	EP081005 (P-50-2.5)

*Other sizes, tolerances, lubricants and materials are available on special orders.



ID	OD	LGTH.	ITEM NO.	PART NO.		ID	OD	LGTH.	ITEM NO.	PART NO.		ID	OD	LGTH.	ITEM NO.	PART NO.													
1/2 X 5/8 NOMINAL (cont.)																													
.502	.628	3/8	201123	EP081006	(P-50-3)	.502	.6905	1	201136	EP081116	(P-51-8)	.502	.753	1-1/4	201147	EP081220	(P-52-10)												
		7/16	201567	EP081007	(P-50-3.5)			1-1/8	201137	EP081118	(P-51-9)			1-1/2	201148	EP081224	(P-52-12)												
		1/2	201124	EP081008	(P-50-4)			1-1/4	201138	EP081120	(P-51-10)			1-3/4	201149	EP081228	(P-52-14)												
		9/16	201568	EP081009	(P-50-4.5)			1-1/2	201139	EP081124	(P-51-12)			2	201150	EP081232	(P-52-16)												
		5/8	201125	EP081010	(P-50-5)	.5025	.689	3/8	101231	AA-631-13		.5025	.753	1/2	101253	AA-744-5													
		11/16	201569	EP081011	(P-50-5.5)			3/4	101232	AA-631				5/8	101254	AA-744-9													
		3/4	201126	EP081012	(P-50-6)			1-1/4	101233	AA-631-1				3/4	101255	AA-744-4													
		7/8	201127	EP081014	(P-50-7)	.503	.690	1/2	401131	SS-1622-8				7/8	101256	AA-744-10													
		1	201128	EP081016	(P-50-8)			5/8	401132	SS-1622-10				1	101257	AA-744-3													
		1-1/8	201129	EP081018	(P-50-9)			3/4	401133	SS-1622-12				1-1/4	101258	AA-744													
		1-1/4	201130	EP081020	(P-50-10)			7/8	401134	SS-1622-14				1-1/2	101259	AA-744-1													
		1-1/2	201131	EP081024	(P-50-12)			1	401135	SS-1622-16				1-3/4	101260	AA-744-2													
.502	.628	3/8	401122	SS-1620-6				1-1/8	401136	SS-1622-18		.503	.753	3/8	401139	SS-1624-6													
		1/2	401123	SS-1620-8				1-1/4	401137	SS-1622-20				1/2	401140	SS-1624-8													
		5/8	401124	SS-1620-10		.504	.690	1/4	101234	AA-618-16				5/8	401141	SS-1624-10													
		3/4	401125	SS-1620-12				1/2	101235	AA-618-1				3/4	401142	SS-1624-12													
		7/8	401126	SS-1620-14				9/16	101236	AA-618-13				7/8	401143	SS-1624-14													
		1	401127	SS-1620-16				5/8	101237	AA-618-12				1	401144	SS-1624-16													
		1-1/8	401128	SS-1620-18				3/4	101238	AA-618-11				1-1/8	401145	SS-1624-18													
		1-1/4	401129	SS-1620-20				7/8	101239	AA-618-8				1-1/4	401146	SS-1624-20													
		1-1/2	401130	SS-1620-24				1	101240	AA-618-6				1-1/2	401147	SS-1624-24													
.5025	.629	1/2	101214	AA-607-1				1-1/8	101241	AA-618-2				1-3/4	401148	SS-1624-28													
		5/8	101215	AA-607-2				1-3/8	101242	AA-618-5				2	401149	SS-1624-32													
		3/4	101216	AA-607-5		1/2 X 13/16 NOMINAL																							
		1	101217	AA-607-3		.5005	.752	1/2	101243	AA-742-1		.501	.815	3/4	101261	AA-886-3													
		1-1/4	101218	AA-607-6				3/4	101244	AA-742-2				1	101262	AA-886-1													
.504	.6275	1/2	101219	AA-634-4				1	101245	AA-742				1-1/2	101263	AA-886-4													
		1	101220	AA-634-5				1-1/8	101246	AA-742-4		.502	.815	1/2	301135	B-813-4													
1/2 X 11/16 NOMINAL																													
.5015	.690	3/8	101221	AA-650-4				1-1/4	101247	AA-742-3				3/4	301136	B-813-6													
		1/2	101222	AA-650-1		.5015	.752	1/2	101248	AA-753				1	301137	B-813-8													
		9/16	101223	AA-650-6				9/16	101249	AA-753-1				1-1/2	301138	B-813-12													
		5/8	101224	AA-650-9				3/4	101250	AA-753-5		.502	.8165	1/2	201151	EP081308	(P-53-4)												
		3/4	101225	AA-650				1	101251	AA-753-2				3/4	201152	EP081312	(P-53-6)												
		7/8	101226	AA-650-7				1-1/2	101252	AA-753-4				1	201153	EP081316	(P-53-8)												
		1	101227	AA-650-2		.502	.753	1/2	301125	B-812-4				1-1/2	201154	EP081324	(P-53-12)												
		1-1/8	101228	AA-650-5				5/8	301126	B-812-5		.503	.815	1/2	401150	SS-1626-8													
		1-1/4	101229	AA-650-12				3/4	301127	B-812-6				3/4	401151	SS-1626-12													
		1-1/2	101230	AA-650-3				7/8	301128	B-812-7				1	401152	SS-1626-16													
.502	.690	1/2	301117	B-811-4				1	301129	B-812-8				1-1/2	401153	SS-1626-24													
		5/8	301118	B-811-5				1-1/8	301130	B-812-9		1/2 X 7/8 NOMINAL																	
		3/4	301119	B-811-6				1-1/4	301131	B-812-10		.502	.878	1/2	301139	B-814-4													
		7/8	301120	B-811-7				1-1/2	301132	B-812-12				5/8	301140	B-814-5													
		1	301121	B-811-8				1-3/4	301133	B-812-14				3/4	301141	B-814-6													
		1-1/8	301122	B-811-9				2	301134	B-812-16				7/8	301142	B-814-7													
		1-1/4	301123	B-811-10		.502	.753	3/8	201140	EP081206	(P-52-3)			1	301143	B-814-8													
		1-1/2	301124	B-811-12				1/2	201141	EP081208	(P-52-4)			1-1/4	301144	B-814-10													
.502	.6905	3/8	201570	EP081106	(P-51-3)			5/8	201142	EP081210	(P-52-5)			1-1/2	301145	B-814-12													
		1/2	201132	EP081108	(P-51-4)			3/4	201143	EP081212	(P-52-6)	.502	.879	1/2	201155	EP081408	(P-54-4)												
		5/8	201133	EP081110	(P-51-5)			7/8	201144	EP081214	(P-52-7)			5/8	201156	EP081410	(P-54-5)												
		3/4	201134	EP081112	(P-51-6)			1	201145	EP081216	(P-52-8)			3/4	201157	EP081412	(P-54-6)												
		7/8	201135	EP081114	(P-51-7)			1-1/8	201146	EP081218	(P-52-9)			7/8	201158	EP081414	(P-54-7)												

*Other sizes, tolerances, lubricants and materials are available on special orders.



ID	OD	LGTH.	ITEM NO.	PART NO.
1/2 X 7/8 NOMINAL (cont.)				
.502	.879	1	201159	EP081416 (P-54-8)
		1-1/4	201160	EP081420 (P-54-10)
		1-1/2	201161	EP081424 (P-54-12)
.503	.878	1/2	401154	SS-1628-8
		5/8	401155	SS-1628-10
		3/4	401156	SS-1628-12
		7/8	401157	SS-1628-14
		1	401158	SS-1628-16
		1-1/4	401159	SS-1628-20
		1-1/2	401160	SS-1628-24
.503	.879	1/2	101264	AA-842-7
		3/4	101265	AA-842-4
		1	101266	AA-842-3
		1-1/4	101267	AA-842-2
		1-1/2	101268	AA-842
1/2 X 1 NOMINAL				
.502	1.004	3/4	201162	EP081612 (P-55-6)
		1	201163	EP081616 (P-55-8)
		1-1/2	201164	EP081624 (P-55-12)
		2	201165	EP081632 (P-55-16)
.503	1.004	3/4	401161	SS-1632-12
		1	401162	SS-1632-16
		1-1/2	401163	SS-1632-24
		2	401164	SS-1632-32
9/16 X 11/16 NOMINAL				
.5635	.691	7/16	101269	AA-620-3
		1/2	101270	AA-620-7
		5/8	101271	AA-620-8
		3/4	101272	AA-620-1
		1	101273	AA-620
		1-1/4	101274	AA-620-5
.5645	.6905	1/2	201166	EP091108 (P-56-4)
		5/8	201571	EP091110 (P-56-5)
		3/4	201167	EP091112 (P-56-6)
		1	201168	EP091116 (P-56-8)
		1-1/4	201169	EP091120 (P-56-10)
		1-1/2	201170	EP091124 (P-56-12)
.565	.690	1/2	401165	SS-1822-8
		3/4	401166	SS-1822-12
		1	401167	SS-1822-16
		1-1/4	401168	SS-1822-20
		1-1/2	401169	SS-1822-24
.565	.691	1/2	301146	B-911-4
		3/4	301147	B-911-6
		1	301148	B-911-8
		1-1/2	301149	B-911-12
.568	.689	1-1/8	101275	AA-658-5
		1-1/2	101276	AA-658-1
9/16 X 3/4 NOMINAL				
.5635	.7535	5/8	101278	AA-711-6
		3/4	101279	AA-711-1
		1	101280	AA-711-3

ID	OD	LGTH.	ITEM NO.	PART NO.
.5635	.7535	1-1/4	101281	AA-711-5
		1-3/8	101282	AA-711
		1-1/2	101283	AA-711-2
.5645	.753	1/2	201171	EP091208 (P-57-4)
		3/4	201172	EP091212 (P-57-6)
		1	201173	EP091216 (P-57-8)
		1-1/4	201174	EP091220 (P-57-10)
		1-1/2	201175	EP091224 (P-57-12)
.565	.753	1/2	301150	B-912-4
		3/4	301151	B-912-6
		1	301152	B-912-8
		1-1/2	301153	B-912-12
.565	.753	1/2	401170	SS-1824-8
		3/4	401171	SS-1824-12
		1	401172	SS-1824-16
		1-1/4	401173	SS-1824-20
		1-1/2	401174	SS-1824-24
.566	.753	1/2	101284	AA-709-7
		3/4	101285	AA-709-8
		1	101286	AA-709
		1-1/4	101287	AA-709-5
		1-1/2	101288	AA-709-6
9/16 X 13/16 NOMINAL				
.563	.815	3/4	101289	AA-807-3
		1	101290	AA-807-2
		1-1/4	101291	AA-807-4
.5645	.8165	1/2	201176	EP091308 (P-58-4)
		3/4	201177	EP091312 (P-58-6)
		1	201178	EP091316 (P-58-8)
		1-1/4	201179	EP091320 (P-58-10)
		1-1/2	201180	EP091324 (P-58-12)
.565	.815	1/2	301154	B-913-4
		3/4	301155	B-913-6
		1	301156	B-913-8
		1-1/4	301157	B-913-10
		1-1/2	301158	B-913-12
.565	.815	1/2	401175	SS-1826-8
		3/4	401176	SS-1826-12
		1	401177	SS-1826-16
		1-1/4	401178	SS-1826-20
		1-1/2	401179	SS-1826-24
9/16 X 7/8 NOMINAL				
.567	.877	1	101292	AA-863-3
		1-3/8	101293	AA-863

ID	OD	LGTH.	ITEM NO.	PART NO.
5/8 X 3/4 NOMINAL				
.626	.753	1/2	101294	AA-724-8
		7/8	101295	AA-724-2
		1	101296	AA-724-3
		1-1/8	101297	AA-724
		1-1/4	101298	AA-724-5
.627	.752	1/2	101299	AA-741
		5/8	101300	AA-741-1
		3/4	101301	AA-741-4
.627	.753	3/8	101302	AA-710-13
		1/2	101303	AA-710-27
		5/8	101304	AA-710-19
		3/4	101305	AA-710-6
		7/8	101306	AA-710-16
		1	101307	AA-710-3
		1-1/8	101308	AA-710-8
		1-1/4	101309	AA-710-5
		1-1/2	101310	AA-710-4
.627	.753	3/8	201572	EP101206 (P-62-3)
		1/2	201181	EP101208 (P-62-4)
		5/8	201182	EP101210 (P-62-5)
		3/4	201183	EP101212 (P-62-6)
		7/8	201184	EP101214 (P-62-7)
		1	201185	EP101216 (P-62-8)
		1-1/8	201186	EP101218 (P-62-9)
		1-1/4	201187	EP101220 (P-62-10)
		1-1/2	201188	EP101224 (P-62-12)
.627	.753	1/2	301159	B-1012-4
		5/8	301160	B-1012-5
		3/4	301161	B-1012-6
		7/8	301162	B-1012-7
		1	301163	B-1012-8
		1-1/8	301164	B-1012-9
		1-1/4	301165	B-1012-10
		1-1/2	301166	B-1012-12
.628	.753	1/2	401180	SS-2024-8
		5/8	401181	SS-2024-10
		3/4	401182	SS-2024-12
		7/8	401183	SS-2024-14
		1	401184	SS-2024-16
		1-1/8	401185	SS-2024-18
		1-1/4	401186	SS-2024-20
		1-1/2	401187	SS-2024-24
5/8 X 13/16 NOMINAL				
.625	.815	1/2	101311	AA-810-4
		5/8	101312	AA-810-2
		3/4	101313	AA-810-10
		7/8	101314	AA-810-1
		1	101315	AA-810-7
		1-1/4	101316	AA-810-11
		1-3/8	101317	AA-810
		1-1/2	101318	AA-810-12
.627	.815	3/4	101319	AA-811-7
		1	101320	AA-811-6

*Other sizes, tolerances, lubricants and materials are available on special orders.



ID	OD	LGTH.	ITEM NO.	PART NO.	ID	OD	LGTH.	ITEM NO.	PART NO.	ID	OD	LGTH.	ITEM NO.	PART NO.		
5/8 X 13/16 NOMINAL (cont.)																
.627	.815	1-1/4	101321	AA-811-2	.627	.878	5/8	301175	B-1014-5	.628	1.003	7/8	301186	B-1016-7		
		1-3/8	101322	AA-811-5			3/4	301176	B-1014-6			1	301187	B-1016-8		
		1-1/2	101323	AA-811-3			7/8	301177	B-1014-7			1-1/4	301188	B-1016-10		
		1-3/4	101324	AA-811-1			1	301178	B-1014-8			1-1/2	301189	B-1016-12		
		1.99	101325	AA-811			1-1/4	301179	B-1014-10			1-3/4	301190	B-1016-14		
.627	.815	1/2	301167	B-1013-4			1-1/2	301180	B-1014-12			2	301191	B-1016-16		
		5/8	301168	B-1013-5			1-3/4	301181	B-1014-14	.628	1.003	1/2	401209	SS-2032-8		
		3/4	301169	B-1013-6	.627	.879	1/2	201197	EP101408 (P-64-4)			5/8	401210	SS-2032-10		
		7/8	301170	B-1013-7			5/8	201198	EP101410 (P-64-5)			3/4	401211	SS-2032-12		
		1	301171	B-1013-8			3/4	201199	EP101412 (P-64-6)			7/8	401212	SS-2032-14		
		1-1/4	301172	B-1013-10			7/8	201200	EP101414 (P-64-7)			1	401213	SS-2032-16		
		1-1/2	301173	B-1013-12			1	201201	EP101416 (P-64-8)			1-1/4	401214	SS-2032-20		
		2	301174	B-1013-16			1-1/8	201202	EP101418 (P-64-9)			1-1/2	401215	SS-2032-24		
.627	.8165	1/2	201189	EP101308 (P-63-4)			1-1/4	201203	EP101420 (P-64-10)			1-3/4	401216	SS-2032-28		
		5/8	201190	EP101310 (P-63-5)			1-1/2	201204	EP101424 (P-64-12)			2	401217	SS-2032-32		
		3/4	201191	EP101312 (P-63-6)			1-3/4	201205	EP101428 (P-64-14)	.628	1.0035	3/4	101348	AA-1011-12		
		7/8	201192	EP101314 (P-63-7)			2	201206	EP101432 (P-64-16)			7/8	101349	AA-1011-5		
		1	201193	EP101316 (P-63-8)	.628	.878	1/2	401196	SS-2028-8			1	101350	AA-1011-3		
		1-1/4	201194	EP101320 (P-63-10)			5/8	401197	SS-2028-10			1-1/8	101351	AA-1011-4		
		1-1/2	201195	EP101324 (P-63-12)			3/4	401198	SS-2028-12			1-1/4	101352	AA-1011-1		
		1-3/4	201196	EP101328 (P-63-14)			7/8	401199	SS-2028-14			1-3/8	101353	AA-1011-13		
.628	.815	1/2	401188	SS-2026-8			1	401200	SS-2028-16			1-1/2	101354	AA-1011		
		5/8	401189	SS-2026-10			1-1/8	401201	SS-2028-18	11/16 X 13/16 NOMINAL						
		3/4	401190	SS-2026-12			1-1/4	401202	SS-2028-20	.6885	.815	1	101355	AA-812-1		
		7/8	401191	SS-2026-14			1-1/2	401203	SS-2028-24			1-1/4	101356	AA-812		
		1	401192	SS-2026-16			1-3/4	401204	SS-2028-28	11/16 X 7/8 NOMINAL						
		1-1/4	401193	SS-2026-20			2	401205	SS-2028-32	.6895	.879	3/4	201219	EP111412 (P-68-6)		
		1-1/2	401194	SS-2026-24			5/8 X 15/16 NOMINAL							1	201220	EP111416 (P-68-8)
		1-3/4	401195	SS-2026-28	.627	.9415	5/8	201207	EP101510 (P-65-5)			1-1/4	201221	EP111420 (P-68-10)		
.628	.8155	5/8	101326	AA-814-3			3/4	201208	EP101512 (P-65-6)			1-1/2	201222	EP111424 (P-68-12)		
		3/4	101327	AA-814-2			1	201209	EP101516 (P-65-8)			1-3/4	201223	EP111428 (P-68-14)		
		1	101328	AA-814	.628	.940	5/8	101345	AA-946-4			2	201224	EP111432 (P-68-16)		
		1-1/4	101329	AA-814-5			3/4	101346	AA-946-2	.690	.878	1/2	101357	AA-851-2		
5/8 X 7/8 NOMINAL							1	101347	AA-946-1			3/4	101358	AA-851-7		
.625	.877	1/2	101330	AA-880-4	.628	.941	5/8	401206	SS-2030-10			1	101359	AA-851-8		
		3/4	101331	AA-880-2			3/4	401207	SS-2030-12			1-1/8	101360	AA-851-6		
		1	101332	AA-880-1			1	401208	SS-2030-16			1-1/4	101361	AA-851-1		
		1-1/2	101333	AA-880	5/8 X 1 NOMINAL					.690	.878	3/4	301192	B-1114-6		
.627	.878	1/2	101334	AA-832-11	.627	1.004	1/2	201210	EP101608 (P-66-4)			1	301193	B-1114-8		
		5/8	101335	AA-832-12			5/8	201211	EP101610 (P-66-5)			1-1/4	301194	B-1114-10		
		3/4	101336	AA-832-6			3/4	201212	EP101612 (P-66-6)			1-1/2	301195	B-1114-12		
		7/8	101337	AA-832-8			7/8	201213	EP101614 (P-66-7)			1-3/4	301196	B-1114-14		
		1	101338	AA-832-1			1	201214	EP101616 (P-66-8)			2	301197	B-1114-16		
		1-1/8	101339	AA-832-13			1-1/4	201215	EP101620 (P-66-10)	.690	.878	3/4	401218	SS-2228-12		
		1-1/4	101340	AA-832-4			1-1/2	201216	EP101624 (P-66-12)			1	401219	SS-2228-16		
		1-3/8	101341	AA-832-2			1-3/4	201217	EP101628 (P-66-14)			1-1/4	401220	SS-2228-20		
		1-1/2	101342	AA-832-5			2	201218	EP101632 (P-66-16)			1-1/2	401221	SS-2228-24		
		1-5/8	101343	AA-832-9	.628	1.003	1/2	301183	B-1016-4			1-3/4	401222	SS-2228-28		
		2	101344	AA-832-18			5/8	301184	B-1016-5			2	401223	SS-2228-32		
							3/4	301185	B-1016-6							

*Other sizes, tolerances, lubricants and materials are available on special orders.



ID	OD	LGTH.	ITEM NO.	PART NO.
11/16 X 15/16 NOMINAL				
.689	.941	1	101362	AA-939-3
		1-1/4	101363	AA-939-2
		1-1/2	101364	AA-939-4
3/4 X 7/8 NOMINAL				
.751	.878	9/16	101365	AA-838-9
		5/8	101366	AA-838-25
		3/4	101367	AA-838-16
		7/8	101368	AA-838-6
		1	101369	AA-838-7
		1-1/8	101370	AA-838-13
		1-1/4	101371	AA-838-5
		1-3/8	101372	AA-838-15
		1-1/2	101373	AA-838-4
		1-5/8	101374	AA-838-8
.752	.878	3/4	101375	AA-885
		1	101376	AA-885-3
		1-1/4	101377	AA-885-4
.752	.879	1/2	201225	EP121408 (P-75-4)
		9/16	201573	EP121409 (P-75-4.5)
		5/8	201226	EP121410 (P-75-5)
		11/16	201574	EP121411 (P-75-5.5)
		3/4	201227	EP121412 (P-75-6)
		7/8	201228	EP121414 (P-75-7)
		1	201229	EP121416 (P-75-8)
		1-1/8	201230	EP121418 (P-75-9)
		1-1/4	201231	EP121420 (P-75-10)
		1-1/2	201232	EP121424 (P-75-12)
		1-5/8	201233	EP121426 (P-75-13)
.753	.878	5/8	101378	AA-839-1
		11/16	101379	AA-839-3
		3/4	101380	AA-839-6
		1	101381	AA-839-13
		1-1/8	101382	AA-839-2
		1-1/4	101383	AA-839-4
		1-1/2	101384	AA-839-7
.753	.878	1/2	301198	B-1214-4
		5/8	301199	B-1214-5
		3/4	301200	B-1214-6
		7/8	301201	B-1214-7
		1	301202	B-1214-8
		1-1/4	301203	B-1214-10
		1-1/2	301204	B-1214-12
		1-5/8	301205	B-1214-13
.753	.878	1/2	401224	SS-2428-8
		5/8	401225	SS-2428-10
		3/4	401226	SS-2428-12
		7/8	401227	SS-2428-14
		1	401228	SS-2428-16
		1-1/8	401229	SS-2428-18
		1-1/4	401230	SS-2428-20
		1-1/2	401231	SS-2428-24
		1-5/8	401232	SS-2428-26

ID	OD	LGTH.	ITEM NO.	PART NO.
3/4 X 15/16 NOMINAL				
.7515	.940	3/4	101385	AA-921-5
		1	101386	AA-921-4
		1-1/8	101387	AA-921-2
		1-1/4	101388	AA-921-3
		1-1/2	101389	AA-921-1
		1-3/4	101390	AA-921
		2	101391	AA-921-6
.752	.9415	1/2	201234	EP121508 (P-76-4)
		5/8	201235	EP121510 (P-76-5)
		3/4	201236	EP121512 (P-76-6)
		7/8	201237	EP121514 (P-76-7)
		1	201238	EP121516 (P-76-8)
		1-1/8	201239	EP121518 (P-76-9)
		1-1/4	201240	EP121520 (P-76-10)
		1-1/2	201241	EP121524 (P-76-12)
		1-5/8	201242	EP121526 (P-76-13)
		1-3/4	201243	EP121528 (P-76-14)
		1-7/8	201244	EP121530 (P-76-15)
		2	201245	EP121532 (P-76-16)
.752	.942	1	101392	AA-912
		1-1/4	101393	AA-912-4
		1-3/8	101394	AA-912-1
		1-1/2	101395	AA-912-6
		1-5/8	101396	AA-912-2
		1-3/4	101397	AA-912-7
.753	.9405	1/2	301206	B-1215-4
		5/8	301207	B-1215-5
		3/4	301208	B-1215-6
		7/8	301209	B-1215-7
		1	301210	B-1215-8
		1-1/4	301211	B-1215-10
		1-1/2	301212	B-1215-12
		1-3/4	301213	B-1215-14
		2	301214	B-1215-16
.753	.941	1/2	401233	SS-2430-8
		5/8	401234	SS-2430-10
		3/4	401235	SS-2430-12
		7/8	401236	SS-2430-14
		1	401237	SS-2430-16
		1-1/8	401238	SS-2430-18
		1-1/4	401239	SS-2430-20
		1-1/2	401240	SS-2430-24
		1-5/8	401241	SS-2430-26
		1-3/4	401242	SS-2430-28
		1-7/8	401243	SS-2430-30
		2	401244	SS-2430-32
3/4 X 1 NOMINAL				
.7505	1.0025	3/4	101398	AA-1005-5
		1	101399	AA-1005-7
		1-1/8	101400	AA-1005-3

ID	OD	LGTH.	ITEM NO.	PART NO.
.7505	1.0025	1-1/4	101401	AA-1005-2
		1-1/2	101402	AA-1005-4
.752	1.0025	3/8	101403	AA-1049-18
		1/2	101404	AA-1049-14
		3/4	101405	AA-1049-1
		7/8	101406	AA-1049-2
		1	101407	AA-1049-3
		1-1/8	101408	AA-1049-16
		1-1/4	101409	AA-1049
		1-3/8	101410	AA-1049-17
		1-1/2	101411	AA-1049-4
		1-3/4	101412	AA-1049-9
		2	101413	AA-1049-5
		2-1/8	101414	AA-1049-11
		2-1/4	101415	AA-1049-12
		2-1/2	101416	AA-1049-6
.752	1.004	1/2	201246	EP121608 (P-77-4)
		5/8	201247	EP121610 (P-77-5)
		3/4	201248	EP121612 (P-77-6)
		7/8	201249	EP121614 (P-77-7)
		1	201250	EP121616 (P-77-8)
		1-1/8	201251	EP121618 (P-77-9)
		1-1/4	201252	EP121620 (P-77-10)
		1-1/2	201253	EP121624 (P-77-12)
		1-3/4	201254	EP121628 (P-77-14)
		2	201255	EP121632 (P-77-16)
		2-1/2	201256	EP121640 (P-77-20)
.753	1.003	3/4	101417	AA-1043-6
		7/8	101418	AA-1043-8
		1	101419	AA-1043-9
		1-1/4	101420	AA-1043
		1-1/2	101421	AA-1043-4
.753	1.003	1/2	301215	B-1216-4
		5/8	301216	B-1216-5
		3/4	301217	B-1216-6
		7/8	301218	B-1216-7
		1	301219	B-1216-8
		1-1/8	301220	B-1216-9
		1-1/4	301221	B-1216-10
		1-1/2	301222	B-1216-12
		1-3/4	301223	B-1216-14
		2	301224	B-1216-16
		2-1/2	301225	B-1216-20
.753	1.003	1/2	401245	SS-2432-8
		5/8	401246	SS-2432-10
		3/4	401247	SS-2432-12
		7/8	401248	SS-2432-14
		1	401249	SS-2432-16
		1-1/8	401250	SS-2432-18
		1-1/4	401251	SS-2432-20
		1-1/2	401252	SS-2432-24
		1-3/4	401253	SS-2432-28
		2	401254	SS-2432-32
		2-1/2	401255	SS-2432-40

*Other sizes, tolerances, lubricants and materials are available on special orders.



ID	OD	LGTH.	ITEM NO.	PART NO.
3/4 X 1-1/16 NOMINAL				
.751	1.0645	1	101422	AA-1039
		1-1/4	101423	AA-1039-2
3/4 X 1-1/8 NOMINAL				
.750	1.129	3/4	101424	AA-1130-3
		1-1/4	101425	AA-1130
.752	1.129	1/2	201257	EP121808 (P-78-4)
		3/4	201258	EP121812 (P-78-6)
		1	201259	EP121816 (P-78-8)
		1-1/4	201260	EP121820 (P-78-10)
		1-1/2	201261	EP121824 (P-78-12)
		1-3/4	201262	EP121828 (P-78-14)
		2	201263	EP121832 (P-78-16)
.753	1.128	3/4	101426	AA-1106-2
		1	101427	AA-1106-4
		1-1/4	101428	AA-1106-3
		1-3/8	101429	AA-1106-13
		1-1/2	101430	AA-1106
		1-3/4	101431	AA-1106-1
.753	1.128	1/2	301226	B-1218-4
		3/4	301227	B-1218-6
		1	301228	B-1218-8
		1-1/4	301229	B-1218-10
		1-1/2	301230	B-1218-12
		1-3/4	301231	B-1218-14
		2	301232	B-1218-16
.753	1.128	1/2	401256	SS-2436-8
		3/4	401257	SS-2436-12
		1	401258	SS-2436-16
		1-1/4	401259	SS-2436-20
		1-1/2	401260	SS-2436-24
		1-3/4	401261	SS-2436-28
		2	401262	SS-2436-32
3/4 X 1-1/4 NOMINAL				
.752	1.254	3/4	201264	EP122012 (P-79-6)
		1	201265	EP122016 (P-79-8)
		1-1/4	201266	EP122020 (P-79-10)
		1-1/2	201267	EP122024 (P-79-12)
.753	1.253	1	101432	AA-1257
		1-1/4	101433	AA-1257-1
		1-1/2	101434	AA-1257-2
.753	1.253	3/4	301233	B-1220-6
		1	301234	B-1220-8
		1-1/4	301235	B-1220-10
		1-1/2	301236	B-1220-12
		1-3/4	301237	B-1220-14
		2	301238	B-1220-16
.753	1.253	3/4	401263	SS-2440-12
		1	401264	SS-2440-16
		1-1/4	401265	SS-2440-20
		1-1/2	401266	SS-2440-24

ID	OD	LGTH.	ITEM NO.	PART NO.
13/16 X 1 NOMINAL				
.8135	1.003	1	101435	AA-1056-5
		1-1/4	101436	AA-1056-3
		1-3/4	101437	AA-1056
.8145	1.003	7/8	101438	AA-1041-2
		1	101439	AA-1041-5
		1-1/4	101440	AA-1041-6
.8145	1.004	3/4	201268	EP131612 (P-81-6)
		1	201269	EP131616 (P-81-8)
		1-1/4	201270	EP131620 (P-81-10)
		1-1/2	201271	EP131624 (P-81-12)
		1-3/4	201272	EP131628 (P-81-14)
.815	1.003	3/4	401267	SS-2632-12
		1	401268	SS-2632-16
		1-1/4	401269	SS-2632-20
		1-1/2	401270	SS-2632-24
		1-3/4	401271	SS-2632-28
		2	401272	SS-2632-32
.8155	1.003	3/4	301239	B-1316-6
		1	301240	B-1316-8
		1-1/4	301241	B-1316-10
		1-1/2	301242	B-1316-12
		1-3/4	301243	B-1316-14
		2	301244	B-1316-16
7/8 X 1 NOMINAL				
.876	1.003	3/8	101441	AA-1008-11
		7/16	101442	AA-1008-14
		1/2	101443	AA-1008-9
		5/8	101444	AA-1008-13
		3/4	101445	AA-1008-5
		1	101446	AA-1008-6
		1-1/4	101447	AA-1008-1
		1-1/2	101448	AA-1008-2
		1-3/4	101449	AA-1008-10
.877	1.003	5/8	101450	AA-1009-5
		3/4	101451	AA-1009-8
		1	101452	AA-1009-3
		1-1/8	101453	AA-1009
		1-1/4	101454	AA-1009-2
.877	1.004	3/8	201575	EP141606 (P-87-3)
		1/2	201576	EP141608 (P-87-4)
		5/8	201577	EP141610 (P-87-5)
		3/4	201275	EP141612 (P-87-6)
		7/8	201276	EP141614 (P-87-7)
		1	201277	EP141616 (P-87-8)
		1-1/4	201278	EP141620 (P-87-10)
.877	1.004	1-1/2	201279	EP141624 (P-87-12)
		1-3/4	201280	EP141628 (P-87-14)
.878	1.003	3/4	301245	B-1416-6
		7/8	301246	B-1416-7
		1	301247	B-1416-8
		1-1/4	301248	B-1416-10

ID	OD	LGTH.	ITEM NO.	PART NO.
		1-1/2	301249	B-1416-12
.878	1.003	1/2	401275	SS-2832-8
		3/4	401276	SS-2832-12
		7/8	401277	SS-2832-14
		1	401278	SS-2832-16
		1-1/4	401279	SS-2832-20
		1-1/2	401280	SS-2832-24
		1-3/4	401281	SS-2832-28
7/8 X 1-1/16 NOMINAL				
.877	1.065	3/4	101455	AA-1051-3
		1-1/4	101456	AA-1051-2
.877	1.0665	1	201281	EP141716 (P-88-8)
		1-1/4	201282	EP141720 (P-88-10)
		1-1/2	201283	EP141724 (P-88-12)
.878	1.0655	1	401282	SS-2834-16
		1-1/4	401283	SS-2834-20
7/8 X 1-1/8 NOMINAL				
.876	1.128	3/4	101457	AA-1108
		7/8	101458	AA-1108-15
		1	101459	AA-1108-1
		1-1/8	101460	AA-1108-2
		1-1/4	101461	AA-1108-7
		1-3/8	101462	AA-1108-16
		1-1/2	101463	AA-1108-12
		1-3/4	101464	AA-1108-10
		2	101465	AA-1108-3
		2-1/4	101466	AA-1108-11
		2-1/2	101467	AA-1108-5
		2-3/4	101468	AA-1108-6
.877	1.129	3/4	201284	EP141812 (P-89-6)
		7/8	201285	EP141814 (P-89-7)
		1	201286	EP141816 (P-89-8)
		1-1/8	201287	EP141818 (P-89-9)
		1-1/4	201288	EP141820 (P-89-10)
		1-3/8	201289	EP141822 (P-89-11)
		1-1/2	201290	EP141824 (P-89-12)
		1-5/8	201291	EP141826 (P-89-13)
		1-3/4	201292	EP141828 (P-89-14)
		2	201293	EP141832 (P-89-16)
		2-1/4	201294	EP141836 (P-89-18)
		2-1/2	201295	EP141840 (P-89-20)
.878	1.1275	1	101469	AA-1104-2
		1-1/4	101470	AA-1104-5
		1-3/8	101471	AA-1104-4
		1-1/2	101472	AA-1104-3
.878	1.128	3/4	301250	B-1418-6
		7/8	301251	B-1418-7
		1	301252	B-1418-8
		1-1/8	301253	B-1418-9
		1-1/4	301254	B-1418-10
		1-3/8	301255	B-1418-11
		1-1/2	301256	B-1418-12



ID	OD	LGTH.	ITEM NO.	PART NO.
7/8 X 1-1/8 NOMINAL (cont.)				
.878	1.128	1-3/4	301257	B-1418-14
		2	301258	B-1418-16
		2-1/2	301259	B-1418-20
.878	1.128	3/4	401284	SS-2836-12
		7/8	401285	SS-2836-14
		1	401286	SS-2836-16
		1-1/8	401287	SS-2836-18
		1-1/4	401288	SS-2836-20
		1-3/8	401289	SS-2836-22
		1-1/2	401290	SS-2836-24
		1-5/8	401291	SS-2836-26
		1-3/4	401292	SS-2836-28
		2	401293	SS-2836-32
		2-1/4	401294	SS-2836-36
		2-1/2	401295	SS-2836-40
7/8 X 1-1/4 NOMINAL				
.877	1.252	1	101473	AA-1203-3
		1-1/4	101474	AA-1203
		1-1/2	101475	AA-1203-1
.877	1.254	3/4	201296	EP142012 (P-90-6)
		1	201297	EP142016 (P-90-8)
		1-1/4	201298	EP142020 (P-90-10)
		1-1/2	201299	EP142024 (P-90-12)
		2	201300	EP142032 (P-90-16)
.878	1.253	3/4	101476	AA-1242-2
		1	101477	AA-1242-3
		1-3/8	101478	AA-1242
.878	1.253	3/4	301260	B-1420-6
		1	301261	B-1420-8
		1-1/4	301262	B-1420-10
		1-1/2	301263	B-1420-12
		2	301264	B-1420-16
.878	1.253	3/4	401296	SS-2840-12
		1	401297	SS-2840-16
		1-1/4	401298	SS-2840-20
		1-1/2	401299	SS-2840-24
		2	401300	SS-2840-32
15/16 X 1-1/16 NOMINAL				
.940	1.065	3/4	101479	AA-1087-1
		1-1/4	101480	AA-1087
15/16 X 1-3/16 NOMINAL				
.939	1.1895	7/8	101481	AA-1118-6
		1	101482	AA-1118-4
		1-1/4	101483	AA-1118-2
		1-1/2	101484	AA-1118-5

ID	OD	LGTH.	ITEM NO.	PART NO.
.9395	1.1915	3/4	201301	EP151912 (P-93-6)
		1	201302	EP151916 (P-93-8)
		1-1/4	201303	EP151920 (P-93-10)
		1-1/2	201304	EP151924 (P-93-12)
		2	201305	EP151932 (P-93-16)
.940	1.190	3/4	401301	SS-3038-12
		1	401302	SS-3038-16
		1-1/4	401303	SS-3038-20
		1-1/2	401304	SS-3038-24
		2	401305	SS-3038-32
.9405	1.1905	3/4	301265	B-1519-6
		1	301266	B-1519-8
		1-1/4	301267	B-1519-10
		1-1/2	301268	B-1519-12
		2	301269	B-1519-16
15/16 X 1-1/4 NOMINAL				
.9375	1.253	1	101485	AA-1206-1
		1-1/4	101486	AA-1206-4
		1-1/2	101487	AA-1206-2
.9395	1.254	3/4	201306	EP152012 (P-94-6)
		1	201307	EP152016 (P-94-8)
		1-1/4	201308	EP152020 (P-94-10)
		1-1/2	201309	EP152024 (P-94-12)
		1-3/4	201310	EP152028 (P-94-14)
		2	201311	EP152032 (P-94-16)
.940	1.254	1-1/2	101488	AA-1216-3
		2	101489	AA-1216
.940	1.254	3/4	401306	SS-3040-12
		1	401307	SS-3040-16
		1-1/4	401308	SS-3040-20
		1-1/2	401309	SS-3040-24
		1-3/4	401310	SS-3040-28
		2	401311	SS-3040-32
.9405	1.253	3/4	301270	B-1520-6
		1	301271	B-1520-8
		1-1/4	301272	B-1520-10
		1-1/2	301273	B-1520-12
		1-3/4	301274	B-1520-14
		2	301275	B-1520-16
1 X 1-1/8 NOMINAL				
1.001	1.128	1/2	101490	AA-1110-8
		3/4	101491	AA-1110-10
		13/16	101492	AA-1110-2
		1	101493	AA-1110-1
		1-1/4	101494	AA-1110-3
		1-3/8	101495	AA-1110-12
		1-1/2	101496	AA-1110
1.003	1.128	3/4	301276	B-1618-6
		1	301277	B-1618-8
		1-1/4	301278	B-1618-10
		1-1/2	301279	B-1618-12
		1-3/4	301280	B-1618-14
		2	301281	B-1618-16

ID	OD	LGTH.	ITEM NO.	PART NO.
1.003	1.129	3/4	201312	EP161812 (P-100-6)
		7/8	201578	EP161814 (P-100-7)
		1	201313	EP161816 (P-100-8)
		1-1/4	201314	EP161820 (P-100-10)
		1-1/2	201315	EP161824 (P-100-12)
		1-3/4	201316	EP161828 (P-100-14)
		2	201317	EP161832 (P-100-16)
1.0035	1.128	3/4	101497	AA-1156
		7/8	101498	AA-1156-4
		1-1/4	101499	AA-1156-3
		1-1/2	101500	AA-1156-1
1.004	1.128	3/4	401312	SS-3236-12
		1	401313	SS-3236-16
		1-1/4	401314	SS-3236-20
		1-1/2	401315	SS-3236-24
		1-3/4	401316	SS-3236-28
		2	401317	SS-3236-32
1 X 1-3/16 NOMINAL				
1.002	1.1895	3/4	101501	AA-1154-2
		1	101502	AA-1154-1
		1-1/2	101503	AA-1154-3
		2	101504	AA-1154
1.003	1.1915	3/4	201318	EP161912 (P-101-6)
		1	201319	EP161916 (P-101-8)
		1-1/4	201320	EP161920 (P-101-10)
		1-1/2	201321	EP161924 (P-101-12)
		1-3/4	201322	EP161928 (P-101-14)
		2	201323	EP161932 (P-101-16)
1.004	1.190	3/4	401318	SS-3238-12
		1	401319	SS-3238-16
		1-1/4	401320	SS-3238-20
		1-1/2	401321	SS-3238-24
		1-3/4	401322	SS-3238-28
		2	401323	SS-3238-32
1 X 1-1/4 NOMINAL				
1.001	1.252	1/2	101505	AA-1212-7
		3/4	101506	AA-1212-6
		1	101507	AA-1212-2
		1-1/4	101508	AA-1212-16
		1-1/2	101509	AA-1212-11
		1-3/4	101510	AA-1212-4
		2	101511	AA-1212-3
		2-1/4	101512	AA-1212-5
		2-1/2	101513	AA-1212
		2-7/8	101514	AA-1212-8
		3	101515	AA-1212-14
1.002	1.252	7/8	101516	AA-1213-6
		1	101517	AA-1213-3
		1-1/8	101518	AA-1213-10
		1-1/4	101519	AA-1213-12
		1-1/2	101520	AA-1213-1

*Other sizes, tolerances, lubricants and materials are available on special orders.



ID	OD	LGTH.	ITEM NO.	PART NO.
1 X 1-1/4 NOMINAL (cont.)				
1.002	1.252	1-3/4	101521	AA-1213-2
		2	101522	AA-1213
		2-1/2	101523	AA-1213-14
		3	101524	AA-1213-15
1.003	1.253	3/4	101525	AA-1232-6
		1	101526	AA-1232
		1-1/8	101527	AA-1232-2
		1-1/4	101528	AA-1232-3
		1-1/2	101529	AA-1232-7
		1-3/4	101530	AA-1232-8
		2	101531	AA-1232-4
		2-1/2	101532	AA-1232-5
1.003	1.253	3/4	301282	B-1620-6
		7/8	301283	B-1620-7
		1	301284	B-1620-8
		1-1/4	301285	B-1620-10
		1-3/8	301286	B-1620-11
		1-1/2	301287	B-1620-12
		1-3/4	301288	B-1620-14
		2	301289	B-1620-16
		2-1/4	301290	B-1620-18
		2-1/2	301291	B-1620-20
		3	301292	B-1620-24
1.003	1.254	1/2	201324	EP162008 (P-102-4)
		3/4	201325	EP162012 (P-102-6)
		7/8	201326	EP162014 (P-102-7)
		1	201327	EP162016 (P-102-8)
		1-1/4	201328	EP162020 (P-102-10)
		1-3/8	201329	EP162022 (P-102-11)
		1-1/2	201330	EP162024 (P-102-12)
		1-3/4	201331	EP162028 (P-102-14)
		2	201332	EP162032 (P-102-16)
		2-1/4	201333	EP162036 (P-102-18)
		2-1/2	201334	EP162040 (P-102-20)
3	201335	EP162048 (P-102-24)		
1.004	1.254	1/2	401324	SS-3240-8
		3/4	401325	SS-3240-12
		7/8	401326	SS-3240-14
		1	401327	SS-3240-16
		1-1/4	401328	SS-3240-20
		1-3/8	401329	SS-3240-22
		1-1/2	401330	SS-3240-24
		1-3/4	401331	SS-3240-28
		2	401332	SS-3240-32
		2-1/4	401333	SS-3240-36
		2-1/2	401334	SS-3240-40
		3	401335	SS-3240-48
		1.005	1.2525	1
1-1/4	101534			AA-1204-2
1-3/8	101535			AA-1204-1
1-1/2	101536			AA-1204

ID	OD	LGTH.	ITEM NO.	PART NO.	
1.005	1.2525	2	101537	AA-1204-3	
		2-1/4	101538	AA-1204-5	
		2-1/2	101539	AA-1204-4	
1 X 1-5/16 NOMINAL					
1.001	1.316	1	101540	AA-1304-3	
		1-1/2	101541	AA-1304	
		1-3/4	101542	AA-1304-4	
1.002	1.315	2	101543	AA-1304-6	
		1	101544	AA-1325-10	
		1-1/4	101545	AA-1325-8	
1.002	1.315	1-1/2	101546	AA-1325-4	
		1-5/8	101547	AA-1325-7	
		1-3/4	101548	AA-1325-5	
1.003	1.3155	2	101549	AA-1325	
		2-1/2	101550	AA-1325-1	
		2-3/4	101551	AA-1325-3	
1.003	1.3155	3	101552	AA-1325-2	
		1	301293	B-1621-8	
		1-1/4	301294	B-1621-10	
1.003	1.3165	1-1/2	301295	B-1621-12	
		1-3/4	301296	B-1621-14	
		2	301297	B-1621-16	
1.003	1.3165	2-1/2	301298	B-1621-20	
		3	301299	B-1621-24	
		1	201336	EP162116 (P-103-8)	
1.003	1.3165	1-1/4	201337	EP162120 (P-103-10)	
		1-1/2	201338	EP162124 (P-103-12)	
		1-3/4	201339	EP162128 (P-103-14)	
1.004	1.316	2	201340	EP162132 (P-103-16)	
		2-1/2	201341	EP162140 (P-103-20)	
		3	201342	EP162148 (P-103-24)	
1.004	1.316	1	401336	SS-3242-16	
		1-1/4	401337	SS-3242-20	
		1-1/2	401338	SS-3242-24	
1.004	1.316	1-3/4	401339	SS-3242-28	
		2	401340	SS-3242-32	
		2-1/2	401341	SS-3242-40	
1.004	1.316	3	401342	SS-3242-48	
		1 X 1-3/8 NOMINAL			
		1.001	1.378	3/4	101553
1-1/4	101554			AA-1334-5	
1-1/2	101555			AA-1334-1	
1.003	1.377	2	101556	AA-1334-2	
		1	101557	AA-1310-2	
		1-1/8	101558	AA-1310-1	
1.003	1.377	1-1/4	101559	AA-1310-4	
		1-3/8	101560	AA-1310	
		1-1/2	101561	AA-1310-5	
1.003	1.377	1-3/4	101562	AA-1310-8	
		2	101563	AA-1310-3	
		2-1/4	101564	AA-1310-6	

ID	OD	LGTH.	ITEM NO.	PART NO.
1.003	1.378	1	301300	B-1622-8
		1-1/4	301301	B-1622-10
		1-1/2	301302	B-1622-12
		1-3/4	301303	B-1622-14
1.003	1.378	2	301304	B-1622-16
		2-1/2	301305	B-1622-20
		3	301306	B-1622-24
		1	201343	EP162216 (P-104-8)
1.003	1.379	1-1/4	201344	EP162220 (P-104-10)
		1-1/2	201345	EP162224 (P-104-12)
		1-3/4	201346	EP162228 (P-104-14)
		2	201347	EP162232 (P-104-16)
1.003	1.379	2-1/2	201348	EP162240 (P-104-20)
		3/4	401343	SS-3244-12
		1	401344	SS-3244-16
		1-1/4	401345	SS-3244-20
1.004	1.379	1-1/2	401346	SS-3244-24
		1-3/4	401347	SS-3244-28
		2	401348	SS-3244-32
		2-1/2	401349	SS-3244-40
1 X 1-1/2 NOMINAL				
1.003	1.503	1	301307	B-1624-8
		1-1/4	301308	B-1624-10
		1-1/2	301309	B-1624-12
		2	301310	B-1624-16
1.003	1.503	2-1/2	301311	B-1624-20
		3	301312	B-1624-24
		1	201349	EP162416 (P-105-8)
		1-1/4	201350	EP162420 (P-105-10)
1.003	1.504	1-1/2	201351	EP162424 (P-105-12)
		1-3/4	201352	EP162428 (P-105-14)
		2	201353	EP162432 (P-105-16)
		2-1/2	201354	EP162440 (P-105-20)
1.0035	1.5045	3	201355	EP162448 (P-105-24)
		1	101565	AA-1511-7
		1-1/4	101566	AA-1511-8
		1-1/2	101567	AA-1511-5
1.004	1.504	2	101568	AA-1511-1
		1	401350	SS-3248-16
		1-1/4	401351	SS-3248-20
		1-1/2	401352	SS-3248-24
1.004	1.504	1-3/4	401353	SS-3248-28
		2	401354	SS-3248-32
		2-1/2	401355	SS-3248-40
		3	401356	SS-3248-48
1-1/16 X 1-5/16 NOMINAL				
1.064	1.317	3/4	101569	AA-1307-2
		1	101570	AA-1307-4
		1-1/4	101571	AA-1307-5
		1-1/2	101572	AA-1307-1



ID	OD	LGTH.	ITEM NO.	PART NO.
1-1/16 X 1-5/16 NOMINAL (cont.)				
1.065	1.316	1	401357	SS-3442-16
		1-1/2	401358	SS-3442-24
		2	401359	SS-3442-32
		2-1/2	401360	SS-3442-40
1.0655	1.3155	1	301313	B-1721-8
		1-1/2	301314	B-1721-12
		2	301315	B-1721-16
		2-1/2	301316	B-1721-20
1.0655	1.3165	1	201356	EP172116 (P-106-8)
		1-1/2	201357	EP172124 (P-106-12)
		2	201358	EP172132 (P-106-16)
		2-1/2	201359	EP172140 (P-106-20)
1-1/8 X 1-1/4 NOMINAL				
1.1245	1.2535	7/8	101573	AA-1214-6
		1	101574	AA-1214-3
		1-1/8	101575	AA-1214-2
		1-1/4	101576	AA-1214-1
		1-1/2	101577	AA-1214-8
1.127	1.2525	1-1/4	101578	AA-1250-2
		1-1/2	101579	AA-1250-3
1.128	1.254	1	201360	EP182016 (P-112-8)
		1-1/4	201361	EP182020 (P-112-10)
		1-1/2	201362	EP182024 (P-112-12)
1.129	1.254	1	401361	SS-3640-16
		1-1/4	401362	SS-3640-20
		1-1/2	401363	SS-3640-24
1-1/8 X 1-5/16 NOMINAL				
1.1265	1.3155	1	101580	AA-1317
		1-1/4	101581	AA-1317-1
1.128	1.3155	1	301317	B-1821-8
		1-1/4	301318	B-1821-10
		1-1/2	301319	B-1821-12
		2	301320	B-1821-16
1.128	1.3165	1	201363	EP182116 (P-113-8)
		1-1/4	201364	EP182120 (P-113-10)
		1-1/2	201365	EP182124 (P-113-12)
		1-3/4	201366	EP182128 (P-113-14)
		2	201367	EP182132 (P-113-16)
1.129	1.316	1	401364	SS-3642-16
		1-1/4	401365	SS-3642-20
		1-1/2	401366	SS-3642-24
		1-3/4	401367	SS-3642-28
		2	401368	SS-3642-32
1-1/8 X 1-3/8 NOMINAL				
1.127	1.377	1/2	101582	AA-1332-6
		3/4	101583	AA-1332-1
		1	101584	AA-1332-4
		1-1/4	101585	AA-1332-9
		1-1/2	101586	AA-1332-7
		1-3/4	101587	AA-1332-10
		2	101588	AA-1332

ID	OD	LGTH.	ITEM NO.	PART NO.
1.127	1.377	2-1/4	101589	AA-1332-11
		2-1/2	101590	AA-1332-2
		3	101591	AA-1332-8
1.128	1.378	3/4	301321	B-1822-6
		1	301322	B-1822-8
		1-1/4	301323	B-1822-10
		1-1/2	301324	B-1822-12
		1-3/4	301325	B-1822-14
		2	301326	B-1822-16
		2-1/2	301327	B-1822-20
		3	301328	B-1822-24
1.128	1.379	1/2	201579	EP182208 (P-114-4)
		3/4	201368	EP182212 (P-114-6)
		1	201369	EP182216 (P-114-8)
		1-1/4	201370	EP182220 (P-114-10)
		1-1/2	201371	EP182224 (P-114-12)
		1-3/4	201372	EP182228 (P-114-14)
		2	201373	EP182232 (P-114-16)
		2-1/2	201374	EP182240 (P-114-20)
		3	201375	EP182248 (P-114-24)
1.129	1.379	1/2	101592	AA-1319-10
		1	101593	AA-1319-3
		1-1/4	101594	AA-1319
		1-1/2	101595	AA-1319-13
		1-3/4	101596	AA-1319-5
		2	101597	AA-1319-1
		2-1/4	101598	AA-1319-12
		2-1/2	101599	AA-1319-2
1.129	1.379	3/4	401369	SS-3644-12
		1	401370	SS-3644-16
		1-1/4	401371	SS-3644-20
		1-1/2	401372	SS-3644-24
		1-3/4	401373	SS-3644-28
		2	401374	SS-3644-32
		2-1/2	401375	SS-3644-40
		3	401376	SS-3644-48
1-1/8 X 1-1/2 NOMINAL				
1.126	1.503	1	101600	AA-1509-4
		1-1/2	101601	AA-1509-1
		1-3/4	101602	AA-1509-6
		2	101603	AA-1509
		2-1/2	101604	AA-1509-3
1.127	1.5035	1	101605	AA-1502
		1-1/4	101606	AA-1502-2
		1-1/2	101607	AA-1502-3
1.128	1.504	1	201376	EP182416 (P-115-8)
		1-1/4	201377	EP182420 (P-115-10)
		1-1/2	201378	EP182424 (P-115-12)
		1-3/4	201379	EP182428 (P-115-14)
		2	201380	EP182432 (P-115-16)
		2-1/2	201381	EP182440 (P-115-20)
1.129	1.504	1	401377	SS-3648-16
		1-1/4	401378	SS-3648-20

ID	OD	LGTH.	ITEM NO.	PART NO.
1.129	1.504	1-1/2	401379	SS-3648-24
		1-3/4	401380	SS-3648-28
		2	401381	SS-3648-32
		2-1/2	401382	SS-3648-40
1-3/16 X 1-5/16 NOMINAL				
1.189	1.3155	1	101608	AA-1339-2
		1-1/4	101609	AA-1339
1-3/16 X 1-3/8 NOMINAL				
1.189	1.379	1-1/2	101610	AA-1324-1
		1-3/4	101611	AA-1324
1-3/16 X 1-7/16 NOMINAL				
1.1885	1.441	1-1/4	101612	AA-1403-3
		1-1/2	101613	AA-1403-7
		2	101614	AA-1403-10
1.1905	1.441	1-1/4	301329	B-1923-10
		2	301330	B-1923-16
		2-1/2	301331	B-1923-20
		3	301332	B-1923-24
1.1905	1.4415	1-1/4	201382	EP192320 (P-118-10)
		1-1/2	201383	EP192324 (P-118-12)
		2	201384	EP192332 (P-118-16)
		2-1/2	201385	EP192340 (P-118-20)
		3	201386	EP192348 (P-118-24)
1.192	1.441	1-1/4	401383	SS-3846-20
		1-1/2	401384	SS-3846-24
		2	401385	SS-3846-32
		2-1/2	401386	SS-3846-40
		3	401387	SS-3846-48
1-3/16 X 1-1/2 NOMINAL				
1.190	1.504	1	101615	AA-1523-2
		1-1/2	101616	AA-1523-5
		2	101617	AA-1523
		2-1/2	101618	AA-1523-3
1.1905	1.503	1	301333	B-1924-8
		1-1/4	301334	B-1924-10
		1-1/2	301335	B-1924-12
		1-3/4	301336	B-1924-14
		2	301337	B-1924-16
		2-1/2	301338	B-1924-20
		3	301339	B-1924-24
1.1905	1.504	1	201387	EP192416 (P-119-8)
		1-1/4	201388	EP192420 (P-119-10)
		1-1/2	201389	EP192424 (P-119-12)
		1-3/4	201390	EP192428 (P-119-14)
		2	201391	EP192432 (P-119-16)
		2-1/2	201392	EP192440 (P-119-20)
		3	201393	EP192448 (P-119-24)

*Other sizes, tolerances, lubricants and materials are available on special orders.



ID	OD	LGTH.	ITEM NO.	PART NO.	ID	OD	LGTH.	ITEM NO.	PART NO.	ID	OD	LGTH.	ITEM NO.	PART NO.
1-3/16 X 1-1/2 NOMINAL (cont.)														
1.192	1.504	1	401388	SS-3848-16	1.2535	1.504	1-1/4	201400	EP202420 (P-125-10)	1.253	1.628	2	301355	B-2026-16
		1-1/4	401389	SS-3848-20			1-3/8	201401	EP202422 (P-125-11)			2-1/2	301356	B-2026-20
		1-1/2	401390	SS-3848-24			1-1/2	201402	EP202424 (P-125-12)			3	301357	B-2026-24
		1-3/4	401391	SS-3848-28			1-5/8	201403	EP202426 (P-125-13)	1.2535	1.630	1	201410	EP202616 (P-126-8)
		2	401392	SS-3848-32			1-3/4	201404	EP202428 (P-125-14)			1-1/4	201411	EP202620 (P-126-10)
		2-1/2	401393	SS-3848-40			1-7/8	201405	EP202430 (P-125-15)			1-1/2	201412	EP202624 (P-126-12)
		3	401394	SS-3848-48			2	201406	EP202432 (P-125-16)			1-3/4	201413	EP202628 (P-126-14)
1.193	1.504	1	101619	AA-1504-6			2-1/4	201407	EP202436 (P-125-18)			2	201414	EP202632 (P-126-16)
		1-1/2	101620	AA-1504-1			2-1/2	201408	EP202440 (P-125-20)			2-1/2	201415	EP202640 (P-126-20)
1-1/4 X 1-7/16 NOMINAL					1.254	1.504	1/2	401395	SS-4048-8			3	201416	EP202648 (P-126-24)
1.2515	1.4405	1-1/4	101621	AA-1407-4			5/8	401396	SS-4048-10	1.254	1.629	1-1/2	101660	AA-1604
		1-1/2	101622	AA-1407-5			3/4	401397	SS-4048-12			1-3/4	101661	AA-1604-2
		1-3/4	101623	AA-1407			7/8	401398	SS-4048-14	1.254	1.629	1	401415	SS-4052-16
		2	101624	AA-1407-6			1	401399	SS-4048-16			1-1/4	401416	SS-4052-20
		2-1/2	101625	AA-1407-8			1-1/8	401400	SS-4048-18			1-1/2	401417	SS-4052-24
1-1/4 X 1-1/2 NOMINAL							1-1/4	401401	SS-4048-20			1-3/4	401418	SS-4052-28
1.250	1.502	3/4	101626	AA-1517-4			1-3/8	401402	SS-4048-22			2	401419	SS-4052-32
		1-1/4	101627	AA-1517-6			1-1/2	401403	SS-4048-24			2-1/2	401420	SS-4052-40
		1-5/8	101628	AA-1517-1			1-5/8	401404	SS-4048-26			3	401421	SS-4052-48
1.252	1.502	1/2	101629	AA-1512-12			1-3/4	401405	SS-4048-28	1-1/4 X 1-3/4 NOMINAL				
		5/8	101630	AA-1512-11			1-7/8	401406	SS-4048-30	1.2535	1.755	1-3/4	201417	EP202828 (P-127-14)
		3/4	101631	AA-1512-14			2	401407	SS-4048-32			2	201418	EP202832 (P-127-16)
		7/8	101632	AA-1512-7			2-1/4	401408	SS-4048-36			2-1/2	201419	EP202840 (P-127-20)
		1	101633	AA-1512-15			2-1/2	401409	SS-4048-40			3	201420	EP202848 (P-127-24)
		1-1/4	101634	AA-1512-16			3	401410	SS-4048-48	1.254	1.753	1-1/2	101662	AA-1715-6
		1-3/8	101635	AA-1512-3	1.258	1.504	1	101644	AA-1505-11			2	101663	AA-1715-2
		1-1/2	101636	AA-1512-2			1-1/2	101645	AA-1505-1			3	101664	AA-1715-3
		1-3/4	101637	AA-1512-17	1-1/4 X 1-9/16 NOMINAL					1.254	1.754	1-1/2	401422	SS-4056-24
		1-7/8	101638	AA-1512-1	1.252	1.565	1-1/4	101646	AA-1506-12			1-3/4	401423	SS-4056-28
		2	101639	AA-1512-5			1-1/2	101647	AA-1506-6			2	401424	SS-4056-32
		2-1/2	101640	AA-1512-13			1-3/4	101648	AA-1506			2-1/2	401425	SS-4056-40
1.253	1.503	1	301340	B-2024-8			2	101649	AA-1506-7			3	401426	SS-4056-48
		1-1/8	301341	B-2024-9			2-1/4	101650	AA-1506-8	1-5/16 X 1-1/2 NOMINAL				
		1-1/4	301342	B-2024-10	1.254	1.566	1	401411	SS-4050-16	1.3155	1.503	1	101665	AA-1526-4
		1-3/8	301343	B-2024-11			1-1/2	401412	SS-4050-24			1-1/4	101666	AA-1526
		1-1/2	301344	B-2024-12	1-1/4 X 1-5/8 NOMINAL							1-1/2	101667	AA-1526-2
		1-5/8	301345	B-2024-13	1.250	1.627	1-1/2	101651	AA-1602			2	101668	AA-1526-3
		1-3/4	301346	B-2024-14	1.252	1.6275	1	101652	AA-1606-9	1-5/16 X 1-5/8 NOMINAL				
		2	301347	B-2024-16			1-1/4	101653	AA-1606	1.3155	1.628	1-1/4	301358	B-2126-10
		2-1/4	301348	B-2024-18			1-1/2	101654	AA-1606-7			1-1/2	301359	B-2126-12
		2-1/2	301349	B-2024-20			1-5/8	101655	AA-1606-11			2	301360	B-2126-16
		3	301350	B-2024-24			1-3/4	101656	AA-1606-1			2-1/2	301361	B-2126-20
1.2535	1.504	1	101641	AA-1528			2	101657	AA-1606-3			3	301362	B-2126-24
		1-1/4	101642	AA-1528-3			2-1/2	101658	AA-1606-5	1.3155	1.629	1-1/2	101669	AA-1611-5
		1-1/2	101643	AA-1528-4			3	101659	AA-1606-4			2	101670	AA-1611-2
1.2535	1.504	1/2	201394	EP202408 (P-125-4)	1.253	1.628	1	301351	B-2026-8			2-1/2	101671	AA-1611
		5/8	201395	EP202410 (P-125-5)			1-1/4	301352	B-2026-10					
		3/4	201396	EP202412 (P-125-6)			1-1/2	301353	B-2026-12					
		7/8	201397	EP202414 (P-125-7)			1-3/4	301354	B-2026-14					
		1	201398	EP202416 (P-125-8)										
		1-1/8	201399	EP202418 (P-125-9)										

*Other sizes, tolerances, lubricants and materials are available on special orders.



ID	OD	LGTH.	ITEM NO.	PART NO.
1-5/16 X 1-5/8 NOMINAL (cont.)				
1.316	1.629	1-1/4	401430	SS-4252-20
		1-1/2	401431	SS-4252-24
		2	401432	SS-4252-32
		2-1/2	401433	SS-4252-40
		3	401434	SS-4252-48
1.316	1.630	1-1/4	201421	EP212620 (P-131-10)
		1-1/2	201422	EP212624 (P-131-12)
		2	201423	EP212632 (P-131-16)
		2-1/2	201424	EP212640 (P-131-20)
		3	201425	EP212648 (P-131-24)
1-3/8 X 1-9/16 NOMINAL				
1.3745	1.5655	1-1/4	101672	AA-1507-2
		1-1/2	101673	AA-1507
1-3/8 X 1-5/8 NOMINAL				
1.376	1.628	1	101674	AA-1608-10
		1-1/8	101675	AA-1608-1
		1-1/4	101676	AA-1608-11
		1-1/2	101677	AA-1608-12
		1-3/4	101678	AA-1608-13
		2	101679	AA-1608
		2-1/2	101680	AA-1608-3
1.378	1.628	1	301363	B-2226-8
		1-1/2	301364	B-2226-12
		2	301365	B-2226-16
		2-1/2	301366	B-2226-20
		3	301367	B-2226-24
1.3785	1.630	1	201426	EP222616 (P-137-8)
		1-1/8	201427	EP222618 (P-137-9)
		1-1/4	201428	EP222620 (P-137-10)
		1-1/2	201429	EP222624 (P-137-12)
		2	201430	EP222632 (P-137-16)
		2-1/2	201431	EP222640 (P-137-20)
		3	201432	EP222648 (P-137-24)
1.379	1.628	1-1/2	101681	AA-1616-3
		2	101682	AA-1616-5
		2-1/2	101683	AA-1616-7
1.379	1.629	1	401435	SS-4452-16
		1-1/8	401436	SS-4452-18
		1-1/4	401437	SS-4452-20
		1-1/2	401438	SS-4452-24
		2	401439	SS-4452-32
		2-1/2	401440	SS-4452-40
		3	401441	SS-4452-48
1-3/8 X 1-3/4 NOMINAL				
1.378	1.753	1	301368	B-2228-8
		1-1/2	301369	B-2228-12
		2	301370	B-2228-16
		2-1/2	301371	B-2228-20
		3	301372	B-2228-24

ID	OD	LGTH.	ITEM NO.	PART NO.		
1.3785	1.755	1	201433	EP222816 (P-138-8)		
		1-1/2	201434	EP222824 (P-138-12)		
		2	201435	EP222832 (P-138-16)		
		2-1/2	201436	EP222840 (P-138-20)		
		3	201437	EP222848 (P-138-24)		
1.379	1.754	1	401442	SS-4456-16		
		1-1/2	401443	SS-4456-24		
		2	401444	SS-4456-32		
		2-1/2	401445	SS-4456-40		
		3	401446	SS-4456-48		
1.380	1.753	1-1/2	101684	AA-1708-5		
		2	101685	AA-1708-2		
		2-1/2	101686	AA-1708		
1-7/16 X 1-5/8 NOMINAL						
1.438	1.628	1	101687	AA-1609-2		
		1-1/2	101688	AA-1609-4		
		2	101689	AA-1609		
		2-1/4	101690	AA-1609-6		
1.441	1.630	1	201438	EP232616 (P-143-8)		
		1-1/2	201439	EP232624 (P-143-12)		
		2	201440	EP232632 (P-143-16)		
1.442	1.629	1	401447	SS-4652-16		
		1-1/2	401448	SS-4652-24		
		2	401449	SS-4652-32		
1-7/16 X 1-3/4 NOMINAL						
1.4405	1.753	1	301373	B-2328-8		
		1-1/4	301374	B-2328-10		
		1-1/2	301375	B-2328-12		
		1-3/4	301376	B-2328-14		
		2	301377	B-2328-16		
		2-1/2	301378	B-2328-20		
		3	301379	B-2328-24		
1.441	1.755	1	201441	EP232816 (P-144-8)		
		1-1/4	201442	EP232820 (P-144-10)		
		1-1/2	201443	EP232824 (P-144-12)		
		1-3/4	201444	EP232828 (P-144-14)		
		2	201445	EP232832 (P-144-16)		
		2-1/2	201446	EP232840 (P-144-20)		
		3	201447	EP232848 (P-144-24)		
1.442	1.754	3/4	401450	SS-4656-12		
		1	401451	SS-4656-16		
		1-1/4	401452	SS-4656-20		
		1-1/2	401453	SS-4656-24		
		1-3/4	401454	SS-4656-28		
		2	401455	SS-4656-32		
		2-1/2	401456	SS-4656-40		
		3	401457	SS-4656-48		
		1.4425	1.7535	7/8	101691	AA-1703-1
				1-1/8	101692	AA-1703-14
		1-1/4	101693	AA-1703-4		
		1-1/2	101694	AA-1703-6		

ID	OD	LGTH.	ITEM NO.	PART NO.
1.4425	1.7535	1-3/4	101695	AA-1703-3
		1-7/8	101696	AA-1703
		2	101697	AA-1703-7
		2-1/4	101698	AA-1703-10
		2-1/2	101699	AA-1703-5
1-1/2 X 1-11/16 NOMINAL				
1.507	1.691	3/4	101700	AA-1612-4
		1	101701	AA-1612-1
1-1/2 X 1-3/4 NOMINAL				
1.503	1.753	1	301380	B-2428-8
		1-1/4	301381	B-2428-10
		1-1/2	301382	B-2428-12
		2	301383	B-2428-16
		2-1/2	301384	B-2428-20
		3	301385	B-2428-24
1.503	1.754	1/2	101702	AA-1704-20
		5/8	101703	AA-1704-21
		3/4	101704	AA-1704-16
		7/8	101705	AA-1704-4
		1	101706	AA-1704-15
		1-1/8	101707	AA-1704-17
		1-1/4	101708	AA-1704-11
		1-3/8	101709	AA-1704-5
		1-1/2	101710	AA-1704
		1-3/4	101711	AA-1704-3
		2	101712	AA-1704-2
		2-1/4	101713	AA-1704-7
		2-1/2	101714	AA-1704-8
		3	101715	AA-1704-9
		3-1/2	101716	AA-1704-19
1.504	1.754	1/2	401458	SS-4856-8
		3/4	401459	SS-4856-12
		1	401460	SS-4856-16
		1-1/4	401461	SS-4856-20
		1-3/8	401462	SS-4856-22
		1-1/2	401463	SS-4856-24
		1-3/4	401464	SS-4856-28
		2	401465	SS-4856-32
		2-1/4	401466	SS-4856-36
		2-1/2	401467	SS-4856-40
		3	401468	SS-4856-48
1.504	1.755	1/2	201580	EP242808 (P-150-4)
		5/8	201581	EP242810 (P-150-5)
		3/4	201448	EP242812 (P-150-6)
		7/8	201449	EP242814 (P-150-7)
		1	201450	EP242816 (P-150-8)
		1-1/4	201451	EP242820 (P-150-10)
		1-3/8	201452	EP242822 (P-150-11)
		1-1/2	201453	EP242824 (P-150-12)
		1-3/4	201454	EP242828 (P-150-14)
		2	201455	EP242832 (P-150-16)

*Other sizes, tolerances, lubricants and materials are available on special orders.



ID	OD	LGTH.	ITEM NO.	PART NO.
1-1/2 X 1-3/4 NOMINAL (cont.)				
1.504	1.755	2-1/4	201456	EP242836 (P-150-18)
		2-1/2	201457	EP242840 (P-150-20)
		3	201458	EP242848 (P-150-24)
1-1/2 X 1-13/16 NOMINAL				
1.502	1.815	1	101717	AA-1801-1
		1-5/8	101718	AA-1801
1.503	1.816	1-1/2	301386	B-2429-12
		3	301387	B-2429-24
1.504	1.816	1	401469	SS-4858-16
		1-1/2	401470	SS-4858-24
		1-5/8	401471	SS-4858-26
		2	401472	SS-4858-32
		3	401473	SS-4858-48
1.504	1.8175	1	201459	EP242916 (P-151-8)
		1-1/2	201460	EP242924 (P-151-12)
		1-5/8	201461	EP242926 (P-151-13)
		3	201462	EP242948 (P-151-24)
1-1/2 X 1-7/8 NOMINAL				
1.503	1.878	1-1/2	101719	AA-1807-9
		1-3/4	101720	AA-1807-10
		2	101721	AA-1807
		2-1/2	101722	AA-1807-11
		2-3/4	101723	AA-1807-1
		3	101724	AA-1807-2
1.503	1.878	1-1/2	301388	B-2430-12
		2	301389	B-2430-16
		2-1/2	301390	B-2430-20
		3	301391	B-2430-24
1.504	1.880	1-1/2	201463	EP243024 (P-152-12)
		2	201464	EP243032 (P-152-16)
		2-1/2	201465	EP243040 (P-152-20)
		2-3/4	201466	EP243044 (P-152-22)
		3	201467	EP243048 (P-152-24)
1.504	1.879	1-1/2	401474	SS-4860-24
		2	401475	SS-4860-32
		2-1/2	401476	SS-4860-40
		2-3/4	401477	SS-4860-44
		3	401478	SS-4860-48
1-1/2 X 2 NOMINAL				
1.503	2.004	1	101725	AA-2007-6
		2	101726	AA-2007-2
		2-1/2	101727	AA-2007-3
		3-1/2	101728	AA-2007-5
1.503	2.004	1	301392	B-2432-8
		1-1/2	301447	B-2432-12
		2	301393	B-2432-16
		2-1/2	301394	B-2432-20
		3	301395	B-2432-24
1.504	2.004	1	401479	SS-4864-16
		1-1/2	401480	SS-4864-24
		2	401481	SS-4864-32

ID	OD	LGTH.	ITEM NO.	PART NO.
1.504	2.004	2-1/2	401482	SS-4864-40
		3	401483	SS-4864-48
		3-1/2	401484	SS-4864-56
1.504	2.005	1	201468	EP243216 (P-153-8)
		1-1/2	201469	EP243224 (P-153-12)
		2	201470	EP243232 (P-153-16)
		2-1/2	201471	EP243240 (P-153-20)
		3	201472	EP243248 (P-153-24)
		3-1/2	201473	EP243256 (P-153-28)
1-5/8 X 1-7/8 NOMINAL				
1.627	1.879	1	101729	AA-1803-10
		1-1/4	101730	AA-1803-11
		1-1/2	101731	AA-1803-13
		1-3/4	101732	AA-1803-14
		2	101733	AA-1803-7
		2-1/4	101734	AA-1803-1
		2-3/4	101735	AA-1803-15
1.628	1.878	1-1/4	301396	B-2630-10
		1-1/2	301397	B-2630-12
		2	301398	B-2630-16
		2-1/2	301399	B-2630-20
		3	301400	B-2630-24
1.629	1.879	1-1/4	401485	SS-5260-20
		1-1/2	401486	SS-5260-24
		1-3/4	401487	SS-5260-28
		2	401488	SS-5260-32
		2-1/4	401489	SS-5260-36
		2-1/2	401490	SS-5260-40
		3	401491	SS-5260-48
1.629	1.880	1-1/4	201474	EP263020 (P-162-10)
		1-1/2	201475	EP263024 (P-162-12)
		1-3/4	201476	EP263028 (P-162-14)
		2	201477	EP263032 (P-162-16)
		2-1/4	201478	EP263036 (P-162-18)
		2-1/2	201479	EP263040 (P-162-20)
		3	201480	EP263048 (P-162-24)
1-5/8 X 2 NOMINAL				
1.6265	2.004	1-1/2	101736	AA-2000-5
		2	101737	AA-2000-1
		2-1/2	101738	AA-2000-3
		3	101739	AA-2000-4
1.628	2.004	1	301401	B-2632-8
		1-1/2	301402	B-2632-12
		2	301403	B-2632-16
		3	301404	B-2632-24
1.629	2.004	1	401492	SS-5264-16
		1-1/2	401493	SS-5264-24
		1-3/4	401494	SS-5264-28
		2	401495	SS-5264-32
		2-1/2	401496	SS-5264-40
		3	401497	SS-5264-48

ID	OD	LGTH.	ITEM NO.	PART NO.
1.629	2.005	1	201481	EP263216 (P-163-8)
		1-1/2	201482	EP263224 (P-163-12)
		2	201483	EP263232 (P-163-16)
		2-1/2	201484	EP263240 (P-163-20)
		3	201485	EP263248 (P-163-24)
1-11/16 X 2-3/16 NOMINAL				
1.6905	2.191	1-3/4	301405	B-2735-14
		2	301406	B-2735-16
		3	301407	B-2735-24
		4	301408	B-2735-32
1.6905	2.1915	2	101740	AA-2107-1
		4	101741	AA-2107
1.6915	2.1925	1-3/4	201486	EP273528 (P-168-14)
		2	201487	EP273532 (P-168-16)
		3	201488	EP273548 (P-168-24)
		4	201489	EP273564 (P-168-32)
1.6915	2.1925	1-3/4	401498	SS-5470-28
		2	401499	SS-5470-32
		3	401500	SS-5470-48
		4	401501	SS-5470-64
1-3/4 X 1-15/16 NOMINAL				
1.7525	1.9415	1-1/4	101742	AA-1904-2
		1-1/2	101743	AA-1904-3
1-3/4 X 2 NOMINAL				
1.753	2.004	1	101744	AA-2001-11
		1-1/2	101745	AA-2001-3
		1-7/8	101746	AA-2001
		2	101747	AA-2001-9
		2-1/2	101748	AA-2001-1
		2-3/4	101749	AA-2001-13
		3	101750	AA-2001-2
1.753	2.004	2	301409	B-2832-16
		2-1/2	301410	B-2832-20
		3	301411	B-2832-24
1.754	2.004	1	401502	SS-5664-16
		1-1/4	401503	SS-5664-20
		1-1/2	401504	SS-5664-24
		1-3/4	401505	SS-5664-28
		2	401506	SS-5664-32
		2-1/2	401507	SS-5664-40
		3	401508	SS-5664-48
1.754	2.005	1	201490	EP283216 (P-175-8)
		1-1/4	201491	EP283220 (P-175-10)
		1-1/2	201492	EP283224 (P-175-12)
		1-3/4	201493	EP283228 (P-175-14)
		2	201494	EP283232 (P-175-16)
		2-1/2	201495	EP283240 (P-175-20)
		3	201496	EP283248 (P-175-24)
1-3/4 X 2-1/8 NOMINAL				
1.753	2.129	1-1/2	301412	B-2834-12
		2	301413	B-2834-16
		3	301414	B-2834-24



ID	OD	LGTH.	ITEM NO.	PART NO.
1-3/4 X 2-1/8 NOMINAL (cont.)				
1.754	2.128	1/2	101751	AA-2112-8
		1-1/2	101752	AA-2112-1
		2	101753	AA-2112-2
		2-1/2	101754	AA-2112-3
1.754	2.129	1-3/8	401509	SS-5668-22
		1-1/2	401510	SS-5668-24
		2	401511	SS-5668-32
		3	401512	SS-5668-48
1.754	2.130	1-1/2	201497	EP283424 (P-176-12)
		2	201498	EP283432 (P-176-16)
		3	201499	EP283448 (P-176-24)
1-3/4 X 2-1/4 NOMINAL				
1.753	2.253	2	101755	AA-2204-2
		2-1/2	101756	AA-2204-3
		3	101757	AA-2204
1-7/8 X 2-1/4 NOMINAL				
1.878	2.254	3/4	101758	AA-2202-10
		2	101759	AA-2202
		2-1/2	101760	AA-2202-1
		3	101761	AA-2202-2
1-15/16 X 2-1/8 NOMINAL				
1.940	2.1285	2	101762	AA-2102-3
		2-1/2	101763	AA-2102-1
1.940	2.1285	2-1/2	401513	SS-6268-40
1-15/16 X 2-5/16 NOMINAL				
1.9405	2.316	2	301415	B-3137-16
		3	301416	B-3137-24
		4	301417	B-3137-32
1.9405	2.3165	2	101764	AA-2306-3
		3	101765	AA-2306-5
		4	101766	AA-2306
1.9405	2.3165	2	401514	SS-6274-32
		2-1/2	401515	SS-6274-40
		3	401516	SS-6274-48
		4	401517	SS-6274-64
1.9415	2.3175	2	201500	EP313732 (P-193-16)
		2-1/2	201501	EP313740 (P-193-20)
		3	201502	EP313748 (P-193-24)
		4	201503	EP313764 (P-193-32)
1-15/16 X 2-7/16 NOMINAL				
1.942	2.4415	1-1/2	101767	AA-2403-1
		2	101768	AA-2403-2
2 X 2-1/4 NOMINAL				
2.003	2.254	3/4	101769	AA-2203-5
		1	101770	AA-2203-6
		1-1/2	101771	AA-2203-7

ID	OD	LGTH.	ITEM NO.	PART NO.
2.003	2.254	2	101772	AA-2203
		2-1/2	101773	AA-2203-9
		3	101774	AA-2203-10
2.004	2.254	1	401518	SS-6472-16
		1-1/2	401519	SS-6472-24
		2	401520	SS-6472-32
		2-1/2	401521	SS-6472-40
		3	401522	SS-6472-48
2.004	2.255	3/4	201582	EP323612 (P-200-6)
		1	201504	EP323616 (P-200-8)
		1-1/2	201505	EP323624 (P-200-12)
		2	201506	EP323632 (P-200-16)
		2-1/2	201507	EP323640 (P-200-20)
		3	201508	EP323648 (P-200-24)
2 X 2-3/8 NOMINAL				
2.003	2.379	1-1/8	101775	AA-2304-6
		1-1/2	101776	AA-2304-7
		1-3/4	101777	AA-2304
		2	101778	AA-2304-1
		2-1/2	101779	AA-2304-2
		3	101780	AA-2304-3
		3-1/2	101781	AA-2304-4
		4	101782	AA-2304-5
2.003	2.379	1-3/4	301418	B-3238-14
		2	301419	B-3238-16
		2-3/4	301420	B-3238-22
		3	301421	B-3238-24
		4	301422	B-3238-32
2.004	2.380	1-1/8	201583	EP323818 (P-201-9)
		1-1/2	201509	EP323824 (P-201-12)
		1-3/4	201510	EP323828 (P-201-14)
		2	201511	EP323832 (P-201-16)
		2-1/2	201512	EP323840 (P-201-20)
		2-3/4	201513	EP323844 (P-201-22)
		3	201514	EP323848 (P-201-24)
		3-1/2	201515	EP323856 (P-201-28)
		4	201516	EP323864 (P-201-32)
2.004	2.380	1-1/2	401523	SS-6476-24
		1-3/4	401524	SS-6476-28
		2	401525	SS-6476-32
		2-1/2	401526	SS-6476-40
		2-3/4	401527	SS-6476-44
		3	401528	SS-6476-48
		3-1/2	401529	SS-6476-56
		4	401530	SS-6476-64
2 X 2-1/2 NOMINAL				
2.003	2.503	1-1/2	101783	AA-2501-1
		2	101784	AA-2501-2
		2-1/2	101785	AA-2501-3
		3	101786	AA-2501

ID	OD	LGTH.	ITEM NO.	PART NO.
2.004	2.504	1	301423	B-3240-8
		2	301424	B-3240-16
		3	301425	B-3240-24
2.004	2.505	1	201517	EP324016 (P-202-8)
		1-1/2	201518	EP324024 (P-202-12)
		2	201519	EP324032 (P-202-16)
		2-1/2	201520	EP324040 (P-202-20)
		3	201521	EP324048 (P-202-24)
		3-1/2	201522	EP324056 (P-202-28)
		4	201523	EP324064 (P-202-32)
2.004	2.505	1	401531	SS-6480-16
		1-1/2	401532	SS-6480-24
		2	401533	SS-6480-32
		2-1/2	401534	SS-6480-40
		3	401535	SS-6480-48
		3-1/2	401536	SS-6480-56
		4	401537	SS-6480-64
2-3/16 X 2-3/8 NOMINAL				
2.190	2.379	1-1/2	101787	AA-2303-1
2-1/4 X 2-5/8 NOMINAL				
2.254	2.6295	2	101788	AA-2605-3
		3	101789	AA-2605-5
		3-1/2	101790	AA-2605
		4-1/2	101791	AA-2605-2
2.254	2.630	2	401538	SS-7284-32
		2-1/2	401539	SS-7284-40
		3	401540	SS-7284-48
2.254	2.631	2	201524	EP364232 (P-225-16)
		2-1/2	201525	EP364240 (P-225-20)
		3	201526	EP364248 (P-225-24)
2-1/4 X 2-3/4 NOMINAL				
2.253	2.753	1-1/2	101792	AA-2703-1
		2	101793	AA-2703-2
		3	101794	AA-2703
2.254	2.754	2	301429	B-3644-16
		3	301430	B-3644-24
2.254	2.755	2	401541	SS-7288-32
		3	401542	SS-7288-48
2.254	2.756	2	201527	EP364432 (P-226-16)
		3	201528	EP364448 (P-226-24)
2-3/8 X 2-5/8 NOMINAL				
2.377	2.6295	1-1/4	101795	AA-2602-3
		1-5/8	101796	AA-2602
2-3/8 X 2-3/4 NOMINAL				
2.379	2.753	2	101797	AA-2701-2
		2-1/2	101798	AA-2701-6
		3	101799	AA-2701
2.379	2.754	2	301432	B-3844-16
		3	301433	B-3844-24
2.379	2.755	2	401543	SS-7688-32
		2-1/2	401544	SS-7688-40
		3	401545	SS-7688-48
2.379	2.756	2	201529	EP384432 (P-237-16)
		2-1/2	201530	EP384440 (P-237-20)
		3	201531	EP384448 (P-237-24)

*Other sizes, tolerances, lubricants and materials are available on special orders.



ID	OD	LGTH.	ITEM NO.	PART NO.
2-1/2 X 2-3/4 NOMINAL				
2.504	2.754	2	401546	SS-8088-32
		2-1/2	401547	SS-8088-40
		3	401548	SS-8088-48
		4	401549	SS-8088-64
2.505	2.754	2	101800	AA-2702-5
		2-1/2	101801	AA-2702-4
		3	101802	AA-2702-1
2.505	2.756	2	201532	EP404432 (P-250-16)
		3	201533	EP404448 (P-250-24)
		4	201534	EP404464 (P-250-32)
2-1/2 X 2-7/8 NOMINAL				
2.504	2.880	2-1/4	101803	AA-2803-1
		2-1/2	101804	AA-2803-3
		3	101805	AA-2803-2
2.504	2.880	2-1/4	401550	SS-8092-36
		2-1/2	401551	SS-8092-40
		3	401552	SS-8092-48
2.505	2.881	2-1/4	201535	EP404636 (P-251-18)
		2-1/2	201536	EP404640 (P-251-20)
		3	201537	EP404648 (P-251-24)
2-1/2 X 3 NOMINAL				
2.504	3.005	2	101806	AA-3005-7
		2-1/2	101807	AA-3005-4
		3	101808	AA-3005-1
		4	101809	AA-3005
2.504	3.005	2	301438	B-4048-16
		3	301439	B-4048-24
		4	301440	B-4048-32
2.504	3.005	2	401553	SS-8096-32
		3	401554	SS-8096-48
		4	401555	SS-8096-64
2.505	3.006	2	201538	EP404832 (P-252-16)
		3	201539	EP404848 (P-252-24)
		4	201540	EP404864 (P-252-32)
2-3/4 X 3 NOMINAL				
2.753	3.005	1-1/2	101810	AA-3006-1
		2-1/2	101811	AA-3006
2.754	3.005	1-1/2	401556	SS-8896-24
		2-1/2	401557	SS-8896-40
2-3/4 X 3-1/8 NOMINAL				
2.753	3.129	1-1/4	101812	AA-3100-7
		2-3/4	101813	AA-3100
		4	101814	AA-3100-11
2-3/4 X 3-1/4 NOMINAL				
2.752	3.254	1-1/2	101815	AA-3201-1
		2	101816	AA-3201-4
		3	101817	AA-3201-7
		4	101818	AA-3201

ID	OD	LGTH.	ITEM NO.	PART NO.
2.754	3.255	2	401558	SS-88104-32
		3	401559	SS-88104-48
		4	401560	SS-88104-64
2.755	3.255	2	301441	B-4452-16
		3	301442	B-4452-24
		4	301443	B-4452-32
2.755	3.257	2	201541	EP445232 (P-275-16)
		3	201542	EP445248 (P-275-24)
		4	201543	EP445264 (P-275-32)
2-15/16 X 3-5/16 NOMINAL				
2.940	3.315	3	401561	SS-94106-48
		3	101819	AA-3301-3
3 X 3-1/4 NOMINAL				
3.002	3.255	1-1/4	101820	AA-3200-5
		2	101821	AA-3200
		3	101822	AA-3200-2
3.005	3.255	2	401562	SS-96104-32
		3	401563	SS-96104-48
3.006	3.257	2	201544	EP485232 (P-300-16)
		3	201545	EP485248 (P-300-24)
3 X 3-1/2 NOMINAL				
3.004	3.505	2-1/2	101823	AA-3502-7
		3	101824	AA-3502-8
		4	101825	AA-3502-3
3.004	3.505	2	301444	B-4856-16
		3	301445	B-4856-24
		4	301446	B-4856-32
3.005	3.505	2	401564	SS-96112-32
		2-1/2	401565	SS-96112-40
		3	401566	SS-96112-48
		4	401567	SS-96112-64
3.006	3.507	2	201546	EP485632 (P-301-16)
		2-1/2	201547	EP485640 (P-301-20)
		3	201548	EP485648 (P-301-24)
		4	201549	EP485664 (P-301-32)
3-1/4 X 3-5/8 NOMINAL				
3.253	3.628	4	101826	AA-3600-5
3.253	3.628	4	401568	SS-104116-64
3-1/2 X 4 NOMINAL				
3.5035	4.004	2	101827	AA-4000-3
		3	101828	AA-4000-5
		3-1/2	101829	AA-4000-6
		4	101830	AA-4000
3.505	4.006	3	401569	SS-112128-48
		3-1/2	401570	SS-112128-56
		4	401571	SS-112128-64

ID	OD	LGTH.	ITEM NO.	PART NO.
3.507	4.008	2	201584	EP566432 (P-350-16)
		3	201550	EP566448 (P-350-24)
		3-1/2	201551	EP566456 (P-350-28)
		4	201552	EP566464 (P-350-32)
4 X 4-1/2 NOMINAL				
4.0035	4.504	4	101831	AA-4500
		6	101832	AA-4500-2
4.0035	4.504	4	401572	SS-128144-64
		6	401573	SS-128144-96
4.008	4.509	4	201553	EP647264 (P-400-32)
4 X 4-5/8 NOMINAL				
4.003	4.628	4	101833	AA-4600-5
4.003	4.628	4	401574	SS-128148-64
4-1/2 X 5-1/4 NOMINAL				
4.504	5.2545	5	101834	AA-5201
4.504	5.2545	5	401575	SS-144168-80
5 X 5-3/4 NOMINAL				
5.004	5.755	2	101835	AA-5700-1
5.004	5.755	2	401576	SS-160184-32

*Other sizes, tolerances, lubricants and materials are available on special orders.



DEC. I.D.	DEC. O.D.	NOM. LGTH.	FLG. O.D.	FLG. THICK	ITEM. NO.	PART. NO.
1/8 X 1/4 NOMINAL						
.126	.252	1/4 3/8	5/16	1/16	102001 102002	FF-207-2 FF-207-3
1/8 X 5/16 NOMINAL						
.127	.315	1/4 3/8	3/8	3/64	302001 302002	FB-25-2 FB-25-3
3/16 X 5/16 NOMINAL						
.187	.313	1/4 3/8	3/8	1/16	102003 102004	FF-313-1 FF-313-2
.189	.3145	1/8 1/4 3/8	3/8	3/64	302003 302004 302005	FB-35-1 FB-35-2 FB-35-3
.1895	.314	3/16 1/4 5/16 3/8 1/2	7/16	1/16	102005 102006 102007 102008 102009	FF-303-1 FF-303-3 FF-303-2 FF-303 FF-303-4
.1895	.314	3/16 1/4 5/16 3/8 1/2	7/16	1/16	402001 402002 402003 402004 402005	SF-610-3 SF-610-4 SF-610-5 SF-610-6 SF-610-8
.1895	.3155	3/16 1/4 5/16 3/8 1/2	7/16	1/16	202088 202089 202090 202001 202091	EF030503 (FL-19-1.5) EF030504 (FL-19-2) EF030505 (FL-19-2.5) EF030506 (FL-19-3) EF030508 (FL-19-4)
3/16 X 3/8 NOMINAL						
.1895	.3765	3/8 1/2	7/16	1/16	102010 102011	FF-307 FF-307-2
1/4 X 3/8 NOMINAL						
.250	.381	3/16 1/4 5/16 3/8 7/16 1/2 9/16 11/16	1/2	1/16	102012 102013 102014 102015 102016 102017 102018 102019	FF-310 FF-310-3 FF-310-4 FF-310-1 FF-310-5 FF-310-2 FF-310-7 FF-310-10
.252	.377	3/16 1/4 5/16 3/8 7/16 1/2 5/8 3/4	15/32	1/16	402006 402007 402008 402009 402010 402011 402012 402013	SF-812-3 SF-812-4 SF-812-5 SF-812-6 SF-812-7 SF-812-8 SF-812-10 SF-812-12
.252	.377	1/4 3/8 1/2 5/8 3/4	1/2	3/64	302006 302007 302008 302009 302010	FB-46-2 FB-46-3 FB-46-4 FB-46-5 FB-46-6
.252	.3775	3/8	15/32	3/64	102023	FF-300
.252	.3775	1/4 3/8 1/2	15/32	1/16	102020 102021 102022	FF-312 FF-312-1 FF-312-2
.252	.378	3/16 1/4 3/8	1/2	1/16	202092 202002 202003	EF040603 (FL-26-1.5) EF040604 (FL-26-2) EF040606 (FL-26-3)
.252	.378	7/16 1/2 5/8 3/4	1/2	1/16	202093 202004 202005 202006	EF040607 (FL-26-3.5) EF040608 (FL-26-4) EF040610 (FL-26-5) EF040612 (FL-26-6)

DEC. I.D.	DEC. O.D.	NOM. LGTH.	FLG. O.D.	FLG. THICK	ITEM. NO.	PART. NO.
.252	.378	1/4 3/8 1/2 5/8 3/4	1/2	1/16	402202 402203 402204 402205 402206	BSF-812-4 BSF-812-6 BSF-812-8 BSF-812-10 BSF-812-12
.253	.377	1/2	1/2	1/16	102024	FF-375-1
1/4 X 7/16 NOMINAL						
.251	.4395	1/2	1/2	1/16	102025	FF-435-1
1/4 X 1/2 NOMINAL						
.252	.503	5/8 3/4	5/8	1/16	102026 102027	FF-565-2 FF-565-3
.252	.503	5/8 3/4	5/8	1/16	402014 402015	SF-816-10 SF-816-12
5/16 X 3/8 NOMINAL						
.314	.377	3/8	1/2	3/64	302011	FB-56-3
5/16 X 7/16 NOMINAL						
.3125	.440	3/8 1/2 7/8	9/16	1/16	102028 102029 102030	FF-411-1 FF-411-2 FF-411-4
.314	.439	3/8 1/2 5/8 3/4 7/8 1	5/8	3/32	302012 302086 302087 302013 302088 302089	FB-57-3 FB-57-4 FB-57-5 FB-57-6 FB-57-7 FB-57-8
.3145	.4405	3/8 1/2 3/4	9/16	1/16	202007 202008 202009	EF050706 (FL-32-3) EF050708 (FL-32-4) EF050712 (FL-32-6)
.315	.440	3/8 1/2 5/8 3/4 7/8 1	9/16	1/16	402016 402017 402018 402019 402020 402021	SF-1014-6 SF-1014-8 SF-1014-10 SF-1014-12 SF-1014-14 SF-1014-16
5/16 X 1/2 NOMINAL						
.3135	.502	3/8	9/16	1/16	102031	FF-501-2
.314	.502	3/8 1/2 5/8	11/16	3/32	302014 302015 302016	FB-58-3 FB-58-4 FB-58-5
.3145	.503	3/8	11/16	1/16	202010	EF050806 (FL-33-3)
.3145	.503	3/8	11/16	1/16	402022	SF-1016-6
3/8 X 1/2 NOMINAL						
.3765	.502	1/4 5/16 3/8 1/2	5/8	1/16	102032 102033 102034 102035	FF-520-15 FF-520-9 FF-520-10 FF-520-5
.3765	.503	1/2 5/8	5/8	3/32	102036 102037	FF-512-2 FF-512-3
.377	.502	1/4 5/16 3/8 1/2 5/8 3/4 1	5/8	1/16	402023 402024 402025 402026 402027 402028 402029	SF-1216-4 SF-1216-5 SF-1216-6 SF-1216-8 SF-1216-10 SF-1216-12 SF-1216-16
.377	.502	3/8 13/32	11/16	3/32	302017 302018	FB-68-3 FB-68-3-1/4
.377	.502	1/2 5/8 3/4	11/16	3/32	302019 302020 302021	FB-68-4 FB-68-5 FB-68-6

*Other sizes, tolerances, lubricants and materials are available on special orders.



DEC. I.D.	DEC. O.D.	NOM. LGTH.	FLG. O.D.	FLG. THICK	ITEM. NO.	PART. NO.	
		7/8			302090	FB-68-7	
		1			302022	FB-68-8	
		1-1/4			302023	FB-68-10	
.377	.503	1/4	11/16	1/16	202094	EF060804	(FL-38-2)
		3/8			202095	EF060806	(FL-38-3)
		1/2			202011	EF060808	(FL-38-4)
		3/4			202012	EF060812	(FL-38-6)
		1			202013	EF060816	(FL-38-8)
.377	.503	1/2	11/16	1/16	402211	BSF-1216-8	
		3/4			402212	BSF-1216-12	
		1			402213	BSF-1216-16	
.378	.503	1/2	3/4	3/32	102038	FF-519-2	
3/8 X 9/16 NOMINAL							
.376	.564	1/2	.740	1/16	102039	FF-503-6	
		11/16			102040	FF-503-4	
		13/16			102041	FF-503	
.377	.5645	1/2	3/4	1/8	302091	FB-69-4	
		3/4			302024	FB-69-6	
		1-1/4			302025	FB-69-10	
.377	.5655	1/2	11/16	1/16	202014	EF060908	(FL-39-4)
		3/4			202015	EF060912	(FL-39-6)
.377	.5655	1/2	11/16	1/16	402030	SF-1218-8	
3/8 X 5/8 NOMINAL							
.376	.627	1/2	7/8	1/16	102042	FF-607-2	
		3/4			102043	FF-607-3	
		1-1/4			102044	FF-607-1	
.377	.627	1/2	7/8	1/16	402031	SF-1220-8	
		3/4			402032	SF-1220-12	
		1			402033	SF-1220-16	
		1-1/4			402034	SF-1220-20	
.377	.627	3/8	7/8	1/8	302092	FB-610-3	
		1/2			302026	FB-610-4	
		5/8			302093	FB-610-5	
		3/4			302027	FB-610-6	
		1			302028	FB-610-8	
		1-1/4			302029	FB-610-10	
.377	.628	1/2	7/8	1/16	202016	EF061008	(FL-40-4)
		3/4			202017	EF061012	(FL-40-6)
		1			202018	EF061016	(FL-40-8)
		1-1/4			202019	EF061020	(FL-40-10)
3/8 X 3/4 NOMINAL							
.377	.753	1/2	1	1/8	302030	FB-612-4	
7/16 X 9/16 NOMINAL							
.439	.565	1/2	11/16	1/16	102045	FF-504-3	
		5/8			102046	FF-504	
		3/4			102047	FF-504-1	
.439	.565	1/2	11/16	1/16	402035	SF-1418-8	
		5/8			402036	SF-1418-10	
		3/4			402037	SF-1418-12	
.4395	.5655	1/2	11/16	1/16	202020	EF070908	(FL-43-4)
		3/4			202021	EF070912	(FL-43-6)
7/16 X 5/8 NOMINAL							
.4385	.627	3/4	7/8	1/8	102048	FF-608-3	
		1-1/4			102049	FF-608	
.439	.628	5/8	7/8	1/8	302031	FB-710-5	
		3/4			302094	FB-710-6	
		1-1/4			302032	FB-710-10	
.439	.628	5/8	7/8	1/8	402038	SF-1420-10	
.439	.628	3/4	7/8	1/8	402039	SF-1420-12	
		1			402040	SF-1420-16	
		1-1/4			402041	SF-1420-20	
.4395	.628	3/4	7/8	1/8	202022	EF071012	(FL-44-6)
		1-1/4			202023	EF071020	(FL-44-10)

DEC. I.D.	DEC. O.D.	NOM. LGTH.	FLG. O.D.	FLG. THICK	ITEM. NO.	PART. NO.	
1/2 X 5/8 NOMINAL							
.502	.627	5/16	3/4	3/32	102053	FF-636-3	
		3/8			102161	FF-636-2	
.502	.627	3/16	7/8	1/16	102054	FF-620-9	
		1/2			102055	FF-620-1	
		9/16			102056	FF-620-5	
		5/8			102057	FF-620-7	
		11/16			102058	FF-620	
		3/4			102059	FF-620-2	
		15/16			102060	FF-620-6	
		1			102061	FF-620-3	
		1-1/8			102062	FF-620-4	
.502	.627	1/4	7/8	1/16	402042	SF-1620-4	
		3/8			402043	SF-1620-6	
		1/2			402044	SF-1620-8	
		9/16			402045	SF-1620-9	
		5/8			402046	SF-1620-10	
		11/16			402047	SF-1620-11	
		3/4			402048	SF-1620-12	
		1			402049	SF-1620-16	
		1-1/4			402050	SF-1620-20	
		1-1/2			402138	SF-1620-24	
.502	.627	1/2	31/32	3/32	102050	FF-600-5	
		1			102051	FF-600-2	
		1-3/4			102052	FF-600	
.502	.628	1/2	7/8	1/8	302033	FB-810-4	
		5/8			302034	FB-810-5	
		3/4			302035	FB-810-6	
		7/8			302095	FB-810-7	
		1			302036	FB-810-8	
		1-1/4			302037	FB-810-10	
		1-1/2			302038	FB-810-12	
		1-3/4			302039	FB-810-14	
.502	.628	5/16	7/8	1/8	202096	EF081005	(FL-50-2.5)
		3/8			202024	EF081006	(FL-50-3)
		1/2			202025	EF081008	(FL-50-4)
		5/8			202097	EF081010	(FL-50-5)
		3/4			202026	EF081012	(FL-50-6)
		1			202027	EF081016	(FL-50-8)
		1-1/4			202028	EF081020	(FL-50-10)
		1-1/2			202029	EF081024	(FL-50-12)
.502	.628	3/8	7/8	1/8	402224	BSF-1620-6	
		1/2			402225	BSF-1620-8	
		3/4			402226	BSF-1620-12	
		1			402227	BSF-1620-16	
		1-1/4			402228	BSF-1620-20	
		1-1/2			402229	BSF-1620-24	
1/2 X 11/16 NOMINAL							
.502	.690	1/2	15/16	1/8	302040	FB-811-4	
		5/8			302096	FB-811-5	
		3/4			302041	FB-811-6	
.502	.6905	5/16	7/8	1/8	202098	EF081105	(FL-51-2.5)
		1/2			202030	EF081108	(FL-51-4)
		3/4			202031	EF081112	(FL-51-6)
.502	.6905	5/16	7/8	1/8	402051	SF-1622-5	
		1/2			402052	SF-1622-8	
		3/4			402053	SF-1622-12	
		7/8			402054	SF-1622-14	
.502	.691	5/16	13/16	1/16	102066	FF-609-1	
		1/2			102067	FF-609-3	
		3/4			102068	FF-609-4	
		13/16			102069	FF-609	

*Other sizes, tolerances, lubricants and materials are available on special orders.



DEC. I.D.	DEC. O.D.	NOM. LGTH.	FLG. O.D.	FLG. THICK	ITEM. NO.	PART. NO.
1/2 X 11/16 NOMINAL						
.502	.691	1/2	31/32	3/32	102063	FF-604-2
		3/4			102064	FF-604-1
		13/16			102065	FF-604
1/2 X 3/4 NOMINAL						
.502	.753	1/2	15/16	1/8	102070	FF-707-5
		3/4			102071	FF-707-2
		1			102072	FF-707-3
.502	.753	3/8	15/16	1/8	402055	SF-1624-6
		1/2			402056	SF-1624-8
		5/8			402057	SF-1624-10
		3/4			402058	SF-1624-12
		1			402059	SF-1624-16
		1-1/4			402060	SF-1624-20
		1-1/2			402061	SF-1624-24
.502	.753	1/2	1	1/8	302042	FB-812-4
		5/8			302097	FB-812-5
		3/4			302043	FB-812-6
		7/8			302044	FB-812-7
		1			302045	FB-812-8
		1-1/4			302046	FB-812-10
		1-1/2			302047	FB-812-12
.502	.753	1/2	1	1/8	202032	EF081208 (FL-52-4)
		5/8			202087	EF081210 (FL-52-5)
		3/4			202033	EF081212 (FL-52-6)
		1			202034	EF081216 (FL-52-8)
		1-1/4			202035	EF081220 (FL-52-10)
.502	.753	1/2	1	1/8	402232	BSF-1624-8
		5/8			402287	BSF-1624-10
		3/4			402233	BSF-1624-12
		1			402234	BSF-1624-16
		1-1/4			402235	BSF-1624-20
.503	.753	3/4	15/16	1/8	102073	FF-710
.505	.753	3/8	1	1/8	102074	FF-723-5
		1/2			102075	FF-723-1
		5/8			102076	FF-723
9/16 X 3/4 NOMINAL						
.565	.753	1/2	1	1/8	302098	FB-912-4
		3/4			302099	FB-912-6
		1			302048	FB-912-8
5/8 X 3/4 NOMINAL						
.626	.753	1/2	1	1/8	302049	FB-1012-4
		5/8			302050	FB-1012-5
		3/4			302051	FB-1012-6
		1			302052	FB-1012-8
		1-1/4			302053	FB-1012-10
.6265	.7525	5/8	1	3/32	102077	FF-703-3
		3/4			102078	FF-703-7
		1			102079	FF-703-1
		1-1/8			102080	FF-703
		1-1/4			102081	FF-703-6
.627	.753	1/2	1	3/32	402062	SF-2024-8
		5/8			402063	SF-2024-10
		3/4			402064	SF-2024-12
		1			402065	SF-2024-16
		1-1/8			402066	SF-2024-18
		1-1/4			402067	SF-2024-20
		1-1/2			402068	SF-2024-24
.627	.753	5/8	1	1/8	202036	EF101210 (FL-62-5)
		3/4			202037	EF101212 (FL-62-6)

DEC. I.D.	DEC. O.D.	NOM. LGTH.	FLG. O.D.	FLG. THICK	ITEM. NO.	PART. NO.
5/8 x 3/4 NOMINAL						
		1			202038	EF101216 (FL-62-8)
		1-1/8			202039	EF101218 (FL-62-9)
.627	.753	5/8	1	1/8	402236	BSF-2024-10
		3/4			402237	BSF-2024-12
		1			402238	BSF-2024-16
		1-1/8			402239	BSF-2024-18
.6275	.7525	1/2	7/8	1/16	102082	FF-718-1
		1			102083	FF-718-3
		1-1/8			102084	FF-718-6
5/8 X 13/16 NOMINAL						
.625	.815	1	1	1/8	102085	FF-823-3
		1-1/4			102086	FF-823
.626	.815	1/2	1	1/8	102087	FF-842-1
		3/4			102088	FF-842-2
		1			102089	FF-842-3
.627	.815	5/8	1-1/16	5/32	302100	FB-1013-5
		3/4			302054	FB-1013-6
		1			302055	FB-1013-8
		1-1/4			302056	FB-1013-10
		1-7/16			302057	FB-1013-11.5
		1-1/2			302058	FB-1013-12
		2			302059	FB-1013-16
.627	.8165	3/4	1	1/8	202040	EF101312 (FL-63-6)
		1			202041	EF101316 (FL-63-8)
		1-1/4			202042	EF101320 (FL-63-10)
		1-1/2			202043	EF101324 (FL-63-12)
.628	.815	3/4	1	1/8	402069	SF-2026-12
		1			402070	SF-2026-16
		1-1/4			402071	SF-2026-20
		1-1/2			402072	SF-2026-24
.628	.816	3/4	1-1/4	1/8	102090	FF-806-1
		1-7/16			102091	FF-806
.6295	.8155	1/2	1	1/8	102092	FF-805-2
		3/4			102093	FF-805
		1			102094	FF-805-3
5/8 X 7/8 NOMINAL						
.627	.877	5/8	1	1/8	102095	FF-843-4
		3/4			102096	FF-843
		1			102097	FF-843-2
		1-1/4			102098	FF-843-3
.627	.878	5/8	1-1/8	5/32	302101	FB-1014-5
		3/4			302060	FB-1014-6
		1			302061	FB-1014-8
		1-3/4			302062	FB-1014-14
.627	.879	1/2	1-1/8	1/8	202044	EF101408 (FL-64-4)
		5/8			202100	EF101410 (FL-64-5)
		3/4			202045	EF101412 (FL-64-6)
		1			202046	EF101416 (FL-64-8)
		1-1/4			202047	EF101420 (FL-64-10)
.627	.879	1/2	1-1/8	1/8	402244	BSF-2028-8
		3/4			402245	BSF-2028-12
		1			402246	BSF-2028-16
		1-1/4			402247	BSF-2028-20
.628	.878	5/8	1-1/8	1/8	402073	SF-2028-10
		3/4			402074	SF-2028-12
		1			402075	SF-2028-16
		1-1/4			402076	SF-2028-20
		1-1/2			402077	SF-2028-24

*Other sizes, tolerances, lubricants and materials are available on special orders.



DEC. I.D.	DEC. O.D.	NOM. LGTH.	FLG. O.D.	FLG. THICK	ITEM. NO.	PART. NO.	
5/8 X 1 NOMINAL							
.627	1.003	3/4	1-1/4	5/32	302102	FB-1016-6	
		1			302063	FB-1016-8	
.627	1.003	1	1-1/4	3/16	402078	SF-2032-16	
.627	1.004	1	1-1/4	3/16	202048	EF101616	(FL-66-8)
3/4 X 7/8 NOMINAL							
.751	.877	1/2	1	1/16	102099	FF-838-1	
		1			102100	FF-838-3	
.752	.878	3/4	1-1/8	5/32	302064	FB-1214-6	
		1			302065	FB-1214-8	
		1-1/4			302103	FB-1214-10	
.752	.879	1/2	1-1/8	1/8	202049	EF121408	(FL-75-4)
		3/4			202050	EF121412	(FL-75-6)
3/4 X 7/8 NOMINAL							
.753	.878	1/2	1-1/8	1/8	402079	SF-2428-8	
		3/4			402080	SF-2428-12	
		1			402081	SF-2428-16	
		1-1/2			402082	SF-2428-24	
3/4 X 15/16 NOMINAL							
.7505	.941	3/4	1-1/8	3/32	102101	FF-911-3	
					102102	FF-911-4	
.752	.940	1	1-3/16	5/32	302066	FB-1215-8	
		1-1/4			302104	FB-1215-10	
		1-1/2			302067	FB-1215-12	
.752	.9415	9/16	1-1/4	1/8	202101	EF121509	(FL-76-4.5)
		3/4			202051	EF121512	(FL-76-6)
		1			202052	EF121516	(FL-76-8)
		1-1/8			202053	EF121518	(FL-76-9)
		1-1/4			202054	EF121520	(FL-76-10)
		1-1/2			202055	EF121524	(FL-76-12)
.753	.938	9/16	1-5/16	1/8	102103	FF-901-4	
		3/4			102104	FF-901-6	
		1-1/4			102105	FF-901-8	
		1-9/16			102106	FF-901	
.753	.940	3/4	1-1/4	1/8	402083	SF-2430-12	
		1			402084	SF-2430-16	
		1-1/8			402085	SF-2430-18	
		1-1/4			402086	SF-2430-20	
		1-1/2			402087	SF-2430-24	
.753	.9405	1-1/8	1.175	1/8	102107	FF-905	
3/4 X 1 NOMINAL							
.7505	1.002	1/2	1-7/16	1/8	102108	FF-1011-2	
		5/8			102109	FF-1011	
		1			102110	FF-1011-4	
		1-1/8			102111	FF-1011-1	
.751	1.002	3/4	1-1/2	1/8	102112	FF-1013-2	
		1			102113	FF-1013	
		1-1/4			102114	FF-1013-3	
		1-1/2			102115	FF-1013-4	
.752	1.002	3/4	1-5/16	1/8	102116	FF-1014-2	
		1			102117	FF-1014	
.752	1.003	5/8	1-1/4	5/32	302105	FB-1216-5	
		3/4			302068	FB-1216-6	
		1-1/2			302069	FB-1216-8	
		1-2/4			302070	FB-1216-10	
					302071	FB-1216-12	
					302072	FB-1216-16	

DEC. I.D.	DEC. O.D.	NOM. LGTH.	FLG. O.D.	FLG. THICK	ITEM. NO.	PART. NO.	
3/4 X 1 NOMINAL							
.752	1.004	5/8	1-1/4	3/16	202056	EF121610	(FL-77-5)
		3/4			202057	EF121612	(FL-77-6)
		1			202058	EF121616	(FL-77-8)
		1-1/8			202059	EF121618	(FL-77-9)
		1-1/4			202060	EF121620	(FL-77-10)
		1-1/2			202061	EF121624	(FL-77-12)
.752	1.004	5/8	1-1/4	3/16	402256	BSF-2432-10	
		3/4			402257	BSF-2432-12	
		1			402258	BSF-2432-16	
		1-1/8			402259	BSF-2432-18	
		1-1/4			402260	BSF-2432-20	
		1-1/2			402261	BSF-2432-24	
.753	1.003	1/2	1-1/8	1/8	102118	FF-1015-1	
		3/4			102119	FF-1015-2	
		1			102120	FF-1015	
.753	1.003	1/2	1-1/8	1/8	402088	SF-2432-8	
		5/8			402089	SF-2432-10	
		3/4			402090	SF-2432-12	
		1			402091	SF-2432-16	
		1-1/8			402092	SF-2432-18	
		1-1/4			402093	SF-2432-20	
		1-1/2			402094	SF-2432-24	
3/4 X 1-1/16 NOMINAL							
.752	1.0655	1-3/16	1-3/16	1/8	102121	FF-1010	
7/8 X 1 NOMINAL							
.8765	1.003	5/8	1-1/4	1/8	102122	FF-1001-2	
		3/4			102123	FF-1001-1	
		1			102124	FF-1001	
.877	1.003	1/2	1-1/4	1/8	402095	SF-2832-8	
		3/4			402096	SF-2832-12	
		1			402097	SF-2832-16	
		1-1/4			402098	SF-2832-20	
		1-1/2			402099	SF-2832-24	
.877	1.003	3/4	1-1/4	5/32	302073	FB-1416-6	
		1			302106	FB-1416-8	
		1-1/4			302074	FB-1416-10	
.877	1.004	1/2	1-1/4	3/16	202062	EF141608	(FL-87-4)
		3/4			202063	EF141612	(FL-87-6)
		1			202064	EF141616	(FL-87-8)
.877	1.004	1/2	1-1/4	3/16	402262	BSF-2832-8	
		3/4			402263	BSF-2832-12	
		1			402264	BSF-2832-16	
7/8 X 1-1/8 NOMINAL							
.877	1.128	1	1-3/8	5/32	302075	FB-1418-8	
		1-1/4			302107	FB-1418-10	
		1-1/2			302076	FB-1418-12	
.877	1.128	5/8	1-1/2	1/8	102125	FF-1102-6	
		1			102126	FF-1102-2	
		1-1/4			102127	FF-1102-3	
		1-3/4			102128	FF-1102	
.877	1.129	3/4	1-1/2	1/8	202065	EF141812	(FL-89-6)
		1			202066	EF141816	(FL-89-8)
		1-1/4			202067	EF141820	(FL-89-10)
		1-1/2			202068	EF141824	(FL-89-12)
		1-3/4			202069	EF141828	(FL-89-14)
.878	1.128	5/8	1-1/2	1/8	402100	SF-2836-10	
		3/4			402101	SF-2836-12	

*Other sizes, tolerances, lubricants and materials are available on special orders.



DEC. I.D.	DEC. O.D.	NOM. LGTH.	FLG. O.D.	FLG. THICK	ITEM. NO.	PART. NO.
7/8 X 1-1/8 NOMINAL						
		1			402102	SF-2836-16
		1-1/4			402103	SF-2836-20
		1-1/2			402104	SF-2836-24
		1-3/4			402105	SF-2836-28
1 X 1-1/4 NOMINAL						
1.001	1.252	3/4	1-1/2	1/8	102129	FF-1213-1
		1-1/2			102130	FF-1213-4
1.001	1.253	3/4	1-7/8	1/8	102131	FF-1202-4
		1			102132	FF-1202-3
		1-1/4			102133	FF-1202
1.002	1.252	3/4	1-5/8	1/8	102134	FF-1207-5
		1-1/4			102135	FF-1207-7
		1-1/2			102136	FF-1207-3
		1-3/4			102137	FF-1207
1.002	1.253	3/4	1-1/2	3/16	302077	FB-1620-6
		1			302078	FB-1620-8
		1-1/4			302079	FB-1620-10
		1-1/2			302080	FB-1620-12
		2			302081	FB-1620-16
1.003	1.253	3/4	1-5/8	1/8	402106	SF-3240-12
		1			402107	SF-3240-16
		1-1/4			402108	SF-3240-20
		1-1/2			402109	SF-3240-24
		1-3/4			402110	SF-3240-28
		2			402111	SF-3240-32
1.003	1.254	3/4	1-1/2	1/8	202070	EF162012 (FL-102-6)
		1			202071	EF162016 (FL-102-8)
1.003	1.254	1-1/4	1-1/2	1/8	202072	EF162020 (FL-102-10)
		1-1/2			202073	EF162024 (FL-102-12)
1.003	1.254	3/4	1-1/2	1/8	402270	BSF-3240-12
		1			402271	BSF-3240-16
		1-1/4			402272	BSF-3240-20
		1-1/2			402273	BSF-3240-24
1 X 1-5/16 NOMINAL						
1.001	1.316	1-1/4	1-3/4	7/32	102138	FF-1302
		1-1/2			102139	FF-1302-3
1.0015	1.3155	1-1/2	1-7/8	1/8	102140	FF-1301
1 X 1-3/8 NOMINAL						
1.000	1.3785	1-3/4	1-3/4	3/16	102141	FF-1304
		2			102142	FF-1304-1
1.002	1.378	1	1-5/8	3/16	302082	FB-1622-8
		1-1/2			302108	FB-1622-12
		1-3/4			302083	FB-1622-14
1.003	1.378	3/4	1-5/8	3/16	402112	SF-3244-12
		1			402113	SF-3244-16
		1-1/2			402114	SF-3244-24
		1-3/4			402115	SF-3244-28
		2			402116	SF-3244-32
1.003	1.379	3/4	1-5/8	3/16	202074	EF162212 (FL-104-6)
		1			202075	EF162216 (FL-104-8)
		1-1/2			202076	EF162224 (FL-104-12)
		1-3/4			202077	EF162228 (FL-104-14)
		2			202078	EF162232 (FL-104-16)
1-1/8 X 1-3/8 NOMINAL						
1.127	1.377	3/4	1-3/4	1/8	102143	FF-1314-1
		1			102144	FF-1314-2
		1-1/4			102145	FF-1314-3
1.127	1.377	3/4	1-3/4	1/8	402117	SF-3644-12
		1			402118	SF-3644-16
		1-1/4			402119	SF-3644-20

DEC. I.D.	DEC. O.D.	NOM. LGTH.	FLG. O.D.	FLG. THICK	ITEM. NO.	PART. NO.
1-1/4 X 1-1/2 NOMINAL						
1.2515	1.503	1/2	1-11/16	1/8	102146	FF-1505-5
		1-1/4			102147	FF-1505
1.252	1.503	1/2	1-11/16	1/8	402120	SF-4048-8
		3/4			402121	SF-4048-12
		1			402122	SF-4048-16
		1-1/4			402123	SF-4048-20
		1-1/2			402124	SF-4048-24
		1-3/4			402125	SF-4048-28
1.252	1.503	1	1-3/4	3/16	302109	FB-2024-8
		1-1/4			302084	FB-2024-10
		1-1/2			302110	FB-2024-12
1.252	1.503	1-1/2	2	3/32	102148	FF-1506-4
		1-3/4			102149	FF-1506-5
1.2535	1.504	1	1-3/4	3/16	202079	EF202416 (FL-125-8)
		1-1/4			202080	EF202420 (FL-125-10)
		1-1/2			202081	EF202424 (FL-125-12)
		1-3/4			202082	EF202428 (FL-125-14)
1.2535	1.504	1-1/4	1-3/4	3/16	402280	BSF-4048-20
		1-1/2			402281	BSF-4048-24
		1-3/4			402282	BSF-4048-28
1-3/8 X 1-5/8 NOMINAL						
1.377	1.628	3/4	2	1/8	102150	FF-1618
		1			102151	FF-1618-1
1.377	1.628	3/4	2	1/8	402126	SF-4452-12
		1			402127	SF-4452-16
1-1/2 X 1-3/4 NOMINAL						
1.503	1.752	1-1/2	2	3/32	102152	FF-1704-4
1.503	1.752	1-1/2	2	3/32	402128	SF-4856-24
1.503	1.754	1-1/2	2-1/16	3/16	302085	FB-2428-12
1.504	1.755	1-1/2	2	3/16	202083	EF242824 (FL-150-12)
1.504	1.755	1-1/2	2	3/16	402283	BSF-4856-24
1-5/8 X 2 NOMINAL						
1.6265	2.004	2	2-1/4	3/16	102153	FF-2000
1.6265	2.004	2	2-1/4	3/16	402129	SF-5264-32
1.629	2.005	2	2-1/4	3/16	202084	EF263232 (FL-163-16)
1-3/4 X 2-1/4 NOMINAL						
1.753	2.254	2-1/2	3	1/4	102154	FF-2204-3
1.753	2.254	2-1/2	3	1/4	402130	SF-5672-40
1.754	2.255	2-1/2	3	1/4	202085	EF283640 (FL-177-20)
2 X 2-1/4 NOMINAL						
2.003	2.254	3/4	2-1/2	1/8	102155	FF-2203-2
		1			102156	FF-2203-3
		1-1/4			102157	FF-2203-4
2.003	2.254	3/4	2-1/2	1/8	402131	SF-6472-12
		1			402132	SF-6472-16
		1-1/4			402133	SF-6472-20
		2	2-1/2	1/8	402134	SF-6472-32
2.004	2.255	2	2-1/2	1/8	202086	EF323632 (FL-200-16)
2 X 2-1/2 NOMINAL						
2.002	2.501	2-3/8	3	3/8	102158	FF-2501
2.002	2.501	2-3/8	3	3/8	402135	SF-6480-38
2-3/4 X 3-1/4 NOMINAL						
2.752	3.250	1-1/2	4-1/2	3/16	102159	FF-3200-4
3 X 3-1/2 NOMINAL						
3.002	3.502	2-3/8	4	3/8	102160	FF-3500
3.002	3.502	2-3/8	4	3/8	402137	SF-96112-38

*Other sizes, tolerances, lubricants and materials are available on special orders.

DECIMAL I.D.	DECIMAL O.D.	THICKNESS	ITEM NO.	PART NO.	
1/4 X 7/16 NOMINAL					
.255	.4375	1/16	102401	TT-400	
.255	.4375	1/16	402401	ST-814-2	
1/4 X 1/2 NOMINAL					
.255	.500	1/16	102402	TT-504	
.255	.500	1/16	402402	ST-816-2	
1/4 X 5/8 NOMINAL					
.252	.628	1/16	202401	EW041001	(TW-25)
.255	.625	1/16	102403	TT-601	
.255	.625	1/16	302401	TB-410	
.255	.625	1/16	402403	ST-820-2	
5/16 X 5/8 NOMINAL					
.3145	.625	1/16	102404	TT-602	
.315	.625	1/16	402404	ST-1020-2	
5/16 X 3/4 NOMINAL					
.3145	.753	1/16	202402	EW051201	(TW-31)
.315	.750	1/16	102405	TT-709-1	
.315	.750	1/16	302402	TB-512	
.315	.750	1/16	402405	ST-1024-2	
3/8 X 5/8 NOMINAL					
.385	.625	1/16	102406	TT-604	
.385	.625	1/16	402406	ST-1220-2	
3/8 X 3/4 NOMINAL					
.377	.753	1/16	202403	EW061201	(TW-37)
		1/8	202429	EW061202	(TW-38)
.3775	.750	1/16	102407	TT-710-1	
		1/8	102408	TT-710-2	
.380	.750	1/32	402407	ST-1224-1	
		1/16	402408	ST-1224-2	
		1/8	402409	ST-1224-4	
.390	.750	1/32	102409	TT-703	
.390	.750	1/32	302403	TB-612	
7/16 X 3/4 NOMINAL					
.4385	.750	1/16	102410	TT-705-1	
.439	.750	1/16	302418	TB-712	
.4395	.753	1/16	202404	EW071201	(TW-43)
.440	.750	1/16	402410	ST-1424-2	
		1/8	402411	ST-1424-4	
1/2 X 3/4 NOMINAL					
.502	.753	1/16	202405	EW081201	(TW-50)
.505	.750	1/16	402412	ST-1624-2	
.507	.750	1/16	102411	TT-706	
.507	.750	1/16	302404	TB-812	
1/2 X 7/8 NOMINAL					
.505	.875	3/16	102412	TT-801	
.505	.875	3/16	302405	TB-814	
.505	.875	3/16	402413	ST-1628-6	
1/2 X 1 NOMINAL					
.502	1.004	1/16	202406	EW081601	(TW-51)
		3/32	202430	EW081601.5	(TW-51.5)
		1/8	202407	EW081602	(TW-52)
.510	1.000	1/16	102413	TT-1001	
		3/32	102414	TT-1001-2	

DECIMAL I.D.	DECIMAL O.D.	THICKNESS	ITEM NO.	PART NO.	
.510	1.000	1/8	102415	TT-1001-1	
.510	1.000	1/16	302406	TB-816	
.510	1.000	1/16	402414	ST-1632-2	
		3/32	402415	ST-1632-3	
		1/8	402416	ST-1632-4	
9/16 X 1-1/4 NOMINAL					
.5645	1.254	1/16	202431	EW092001	(TW-55)
		1/8	202408	EW092002	(TW-56)
.565	1.250	1/16	102416	TT-1200-1	
		1/8	102417	TT-1200	
.565	1.250	1/8	302407	TB-920	
.565	1.250	1/16	402417	ST-1840-2	
		1/8	402418	ST-1840-4	
5/8 X 1 NOMINAL					
.627	1.004	1/16	202409	EW101601	(TW-62)
		1/8	202410	EW101602	(TW-63)
.628	1.000	1/16	102418	TT-1002-1	
		1/8	102419	TT-1002	
.628	1.000	1/8	302408	TB-1016	
.628	1.000	1/16	402419	ST-2032-2	
		1/8	402420	ST-2032-4	
5/8 X 1-3/16 NOMINAL					
.627	1.187	3/32	302409	TB-1019	
.627	1.1875	1/16	102420	TT-1102-1	
		3/32	102421	TT-1102	
		1/8	102422	TT-1102-2	
.627	1.1915	1/16	202432	EW101901	(TW-63.5)
		3/32	202411	EW101902	(TW-64)
		1/8	202433	EW101903	(TW-64.5)
.628	1.1875	1/16	402421	ST-2038-2	
		3/32	402422	ST-2038-3	
		1/8	402423	ST-2038-4	
5/8 X 1-1/4 NOMINAL					
.627	1.254	1/16	202434	EW102001	(TW-64.7)
		1/8	202412	EW102002	(TW-65)
.628	1.250	1/16	102423	TT-1204	
		1/8	102424	TT-1204-1	
.628	1.250	1/16	402424	ST-2040-2	
		1/8	402425	ST-2040-4	
.6285	1.250	1/8	302419	TB-1020	
5/8 X 1-1/2 NOMINAL					
.6265	1.500	1/8	302420	TB-1024	
21/32 X 1-1/2 NOMINAL					
.656	1.500	1/16	102425	TT-1508-1	
		1/8	102426	TT-1508-2	
.656	1.500	1/16	402426	ST-2148-2	
		1/8	402427	ST-2148-4	
3/4 X 1-1/4 NOMINAL					
.7515	1.250	1/8	302421	TB-1220	
.752	1.254	1/16	202413	EW122001	(TW-75)
		1/8	202414	EW122002	(TW-76)
.753	1.250	1/16	102427	TT-1205	
		1/8	102428	TT-1205-1	
.753	1.250	1/16	402428	ST-2440-2	
		1/8	402429	ST-2440-4	

*Other sizes, tolerances, lubricants and materials are available on special orders.

DECIMAL I.D.	DECIMAL O.D.	THICKNESS	ITEM NO.	PART NO.
3/4 X 1-3/8 NOMINAL				
.752	1.375	1/8	302422	TB-1222
.752	1.379	1/8	202415	EW122202 (TW-77)
.753	1.375	1/16	102429	TT-1303-1
		1/8	102430	TT-1303-2
		1/4	102431	TT-1303-4
.753	1.375	1/16	402430	ST-2444-2
		1/8	402431	ST-2444-4
		1/4	402432	ST-2444-8
3/4 X 1-9/16 NOMINAL				
.752	1.5675	3/32	202416	EW122502 (TW-78)
.765	1.562	3/32	302410	TB-1225
.765	1.5625	3/32	102432	TT-1501-1
.765	1.5625	3/32	402433	ST-2450-3
3/4 X 1-3/4 NOMINAL				
.752	1.755	1/8	202417	EW122802 (TW-79)
.765	1.750	1/8	102433	TT-1701
.765	1.750	1/8	302411	TB-1228
.765	1.750	1/8	402434	ST-2456-4
7/8 X 1-1/2 NOMINAL				
.877	1.504	1/16	202435	EW142401 (TW-86)
.877	1.504	1/8	202418	EW142402 (TW-87)
.890	1.500	1/8	302412	TB-1424
.8905	1.500	1/16	102434	TT-1503-2
		1/8	102435	TT-1503
.8905	1.500	1/16	402435	ST-2848-2
		1/8	402436	ST-2848-4
7/8 X 2 NOMINAL				
.880	2.000	1/8	102436	TT-2007
.880	2.000	1/8	402437	ST-2864-4
7/8 X 2-1/8 NOMINAL				
.890	2.125	1/8	302413	TB-1434
.8905	2.125	1/8	102437	TT-2101-1
.8905	2.125	1/8	402438	ST-2868-4
1 X 1-1/2 NOMINAL				
1.003	1.500	1/16	402439	ST-3248-2
		1/8	402440	ST-3248-4
		3/16	402441	ST-3248-6
1.003	1.504	1/16	102438	TT-1502-2
		1/8	102439	TT-1502
		3/16	102440	TT-1502-1
1.003	1.504	1/8	302414	TB-1624
1.003	1.504	1/16	202436	EW162401 (TW-99)
1.003	1.504	1/8	202419	EW162402 (TW-100)
1 X 1-5/8 NOMINAL				
1.003	1.630	1/16	202437	EW16260 (TW-100.5)
		1/8	202420	EW162602 (TW-101)
		1/4	202438	EW162604 (TW-101.5)
1.0155	1.625	1/16	102441	TT-1603-3
		1/8	102442	TT-1603
		1/4	102443	TT-1603-4
1.0155	1.625	1/16	402442	ST-3252-2
		1/8	402443	ST-3252-4
		1/4	402444	ST-3252-8

DECIMAL I.D.	DECIMAL O.D.	THICKNESS	ITEM NO.	PART NO.
1 X 1-3/4 NOMINAL				
1.012	1.750	1/8	302426	TB-1628
1.012	1.750	1/16	102444	TT-1709-1
		1/8	102445	TT-1709
1.012	1.750	1/16	402445	ST-3256-2
		1/8	402446	ST-3256-4
1 X 2 NOMINAL				
1.003	2.005	1/8	202421	EW163202 (TW-102)
		3/16	202439	EW163203 (TW-103)
1.016	2.000	1/8	102446	TT-2001
		3/16	102447	TT-2001-1
1.016	2.000	1/8	302415	TB-1632
		1/8	402447	ST-3264-4
1.016	2.000	3/16	402448	ST-3264-6
		1 X 2-7/8 NOMINAL		
1.0155	2.875	1/8	102448	TT-2800
1.0155	2.875	1/8	402449	ST-3292-4
1-1/16 X 2-3/8 NOMINAL				
1.0625	2.375	1/16	102449	TT-2301-4
		1/8	102450	TT-2301-3
1.0625	2.375	1/16	402450	ST-3476-2
		1/8	402451	ST-3476-4
1-1/8 X 1-7/8 NOMINAL				
1.140	1.875	1/8	102451	TT-1800-1
1.140	1.875	1/8	402452	ST-3660-4
1-1/4 X 1-11/16 NOMINAL				
1.253	1.690	1/8	102452	TT-1602
1.253	1.690	1/8	402453	ST-4054-4
1.2535	1.6925	1/8	202422	EW202702 (TW-125)
1-1/4 X 1-3/4 NOMINAL				
1.253	1.750	1/8	302416	TB-2028
1-1/4 X 2 NOMINAL				
1.2535	2.005	1/16	202440	EW203201 (TW-126.5)
		1/8	202423	EW203202 (TW-126)
1.265	2.000	1/16	102453	TT-2006
		1/8	102454	TT-2006-1
1.265	2.000	1/16	402454	ST-4064-2
		1/8	402455	ST-4064-4
1-1/4 X 2-3/8 NOMINAL				
1.265	2.375	1/16	102455	TT-2304-1
		1/8	102456	TT-2304-2
1.265	2.375	1/16	402456	ST-4076-2
		1/8	402457	ST-4076-4
1-1/4 X 3-5/16 NOMINAL				
1.255	3.312	1/16	102457	TT-3301
		1/8	102458	TT-3301-1
1.255	3.312	1/16	402458	ST-40106-2
		1/8	402459	ST-40106-4
1-3/8 X 1-15/16 NOMINAL				
1.379	1.940	1/8	102459	TT-1900
1.379	1.940	1/8	402460	ST-4462-4

*Other sizes, tolerances, lubricants and materials are available on special orders.

DECIMAL I.D.	DECIMAL O.D.	THICKNESS	ITEM NO.	PART NO.
1-1/2 X 2 NOMINAL				
1.503	2.000	1/8	102460	TT-2008
1.503	2.000	1/8	402461	ST-4864-4
1-1/2 X 2-1/2 NOMINAL				
1.504	2.505	1/8	202424	EW244002 (TW-150)
1.505	2.505	1/8	302434	TB-2440
1.505	2.505	1/8	402462	ST-4880-4
1-1/2 X 3-1/2 NOMINAL				
1.504	3.507	3/16	202425	EW245603 (TW-151)
1.510	3.500	3/16	102461	TT-3500-1
1.510	3.500	3/16	302417	TB-2456
1.510	3.500	3/16	402463	ST-48112-6
1-9/16 X 2-7/16 NOMINAL				
1.578	2.4375	1/8	102462	TT-2402
1.578	2.4375	1/8	402464	ST-5078-4
1-3/4 X 2-7/16 NOMINAL				
1.755	2.440	1/8	102463	TT-2400-1
1.755	2.440	1/8	402465	ST-5678-4
1-3/4 X 2-5/8 NOMINAL				
1.754	2.631	1/8	202426	EW284202 (TW-175)
1.765	2.625	1/8	102464	TT-2601
1.765	2.625	1/8	402466	ST-5684-4
1-15/16 X 2-5/8 NOMINAL				
1.953	2.625	1/8	102465	TT-2600
1.953	2.625	1/8	402467	ST-6284-4
2 X 3 NOMINAL				
2.004	3.00	1/8	202427	EW324802 (TW-200)
		1/4	202428	EW324804 (TW-201)
2.010	3.000	1/8	102467	TT-3001-3
		3/16	102466	TT-3001
		1/4	102468	TT-3001-1
2.011	3.000	1/8	402468	ST-6496-4
		3/16	402469	ST-6496-6
		1/4	402470	ST-6496-8
2 X 3-5/8 NOMINAL				
2.031	3.625	3/16	102469	TT-3600
2.031	3.625	3/16	402471	ST-64116-6
2-1/16 X 4 NOMINAL				
2.062	4.000	1/8	102470	TT-4002-1
2.062	4.000	1/4	102471	TT-4002
2.062	4.000	1/8	402472	ST-66128-4
2.062	4.000	1/4	402473	ST-66128-8
2-1/2 X 3-1/4 NOMINAL				
2.502	3.250	1/8	102472	TT-3200
2.502	3.250	1/8	402474	ST-80104-4
2-3/4 X 3-7/8 NOMINAL				
2.766	3.875	1/4	102473	TT-3800
2.766	3.875	1/4	402475	ST-88124-8

*Other sizes, tolerances, lubricants and materials are available on special orders.



CORED BAR STOCK

I.D.	O.D.	LENGTH	ITEM NO.	PART NO.
1/2	1	6-1/2	102601	CC-1000-2
	1-1/8	6-1/2	102602	CC-1103
	1-1/4	6-1/2	102603	CC-1203
	1-1/2	6-1/2	102604	CC-1502
	2	6-1/2	102605	CC-2005
5/8	1	6-1/2	102606	CC-1001
	1-1/8	6-1/2	102607	CC-1101-1
	1-1/4	6-1/2	102608	CC-1200-1
	1-3/8	6-1/2	102609	CC-1302
	1-1/2	6-1/2	102610	CC-1503
	1-3/4	6-1/2	102611	CC-1703
	2	6-1/2	102612	CC-2006
	3/4	1-1/4	6-1/2	102613
1-1/2		6-1/2	102614	CC-1500-1
1-3/4		6-1/2	102615	CC-1702
2		6-1/2	102616	CC-2001
2-1/4		6-1/2	102617	CC-2206
2-1/2		6-1/2	102618	CC-2504
2-3/4		6-1/2	102619	CC-2704
7/8	1-3/8	6-1/2	102620	CC-1301
	1-1/2	6-1/2	102621	CC-1504
	2	6-1/2	102622	CC-2007
	2-1/4	6-1/2	102623	CC-2207
1	1-1/2	6-1/2	102624	CC-1501
	1-5/8	6-1/2	102625	CC-1600-1
	1-3/4	6-1/2	102626	CC-1700-2
	2	6-1/2	102627	CC-2002
	2-1/4	6-1/2	102628	CC-2202-2
	2-1/2	6-1/2	102629	CC-2501
	3	6-1/2	102630	CC-3001
	3-1/2	6-1/2	102631	CC-3504
1-1/8	2-1/8	6-1/2	102633	CC-2102
	1-1/4	1-3/4	6-1/2	102634
2		6-1/2	102635	CC-2000-1
2-1/4		6-1/2	102636	CC-2203
2-1/2		6-1/2	102637	CC-2502
3		6-1/2	102638	CC-3003
3-1/2		6-1/2	102639	CC-3505
1-3/8	2	6-1/2	102641	CC-2003
	2-3/4	6-1/2	102642	CC-2702
1-1/2	2	6-1/2	102643	CC-2004
	2-1/4	6-1/2	102644	CC-2200-1
	2-1/2	6-1/2	102645	CC-2503
	2-3/4	6-1/2	102646	CC-2701
	3	6-1/2	102647	CC-3002
	3-1/2	6-1/2	102648	CC-3502
1-3/4	4	6-1/2	102649	CC-4007
	2-1/4	6-1/2	102650	CC-2201-3
	2-1/2	6-1/2	102651	CC-2500-1
	2-5/8	6-1/2	102652	CC-2604
	2-3/4	6-1/2	102653	CC-2703
	3	6-1/2	102654	CC-3005
	3-1/2	6-1/2	102655	CC-3503
4-1/4	6-1/2	102656	CC-4202	
4-1/2	6-1/2	102657	CC-4502	

SOLID BAR STOCK

I.D.	O.D.	LENGTH	ITEM NO.	PART NO.	
2	2-3/4	6-1/2	102658	CC-2700-1	
	3	6-1/2	102659	CC-3000	
	3-1/4	6-1/2	102660	CC-3201-2	
	4	6-1/2	102661	CC-4003	
	4-1/2	6-1/2	102662	CC-4501	
	5	6-1/2	102663	CC-5000	
2-1/4	5-1/2	6-1/2	102664	CC-5500	
	3	6-1/2	102665	CC-3006	
	3-1/4	6-1/2	102666	CC-3202-1	
	3-1/2	6-1/2	102667	CC-3500-1	
	3-3/4	6-1/2	102668	CC-3703	
	4	6-1/2	102669	CC-4008	
2-3/8	4-1/2	6-1/2	102670	CC-4503	
	3	6-1/2	102671	CC-3007	
	3-1/2	6-1/2	102672	CC-3507	
	4	6-1/2	102673	CC-4009	
	4-1/2	6-1/2	102674	CC-4504	
	2-1/2	3-1/2	6-1/2	102675	CC-3501
3-3/4		6-1/2	102676	CC-3702	
4		6-1/2	102677	CC-4010	
4-1/4		6-1/2	102678	CC-4203	
4-1/2		6-1/2	102679	CC-4505	
5		6-1/2	102680	CC-5001	
2-3/4	3-3/4	6-1/2	102681	CC-3700-1	
3	3-3/4	6-1/2	102682	CC-3701-1	
	4	6-1/2	102683	CC-4001	
	4-1/2	6-1/2	102684	CC-4506	
	5	6-1/2	102685	CC-5002	
	6	6-1/2	102686	CC-6000	
	3-1/4	4-1/4	6-1/2	102688	CC-4200-1
3-1/2	4-3/4	6-1/2	102689	CC-4700-2	
	5	6-1/2	102690	CC-5003	
	6	6-1/2	102691	CC-6002	
3-3/4	5	6-1/2	102692	CC-5004	
4	5-1/2	6-1/2	102693	CC-5501	
	6	6-1/2	102694	CC-6001	
	7	6-1/2	102695	CC-7001	
	8	6-1/2	102696	CC-8000	
	4-1/2	6	6-1/2	102697	CC-6003
	5	7	6-1/2	102698	CC-7000
6	8	6-1/2	102699	CC-8001	
	7-3/4	10-3/8	6-1/8†	102702	CC-10301

† Modified Lengths

O.D.	LENGTH	ITEM NO.	PART NO.
1/4	2	102801	BB-200
3/8	3	102802	BB-302
1/2	6-1/2	102803	BB-500
5/8	6-1/2	102804	BB-600-1
3/4	6-1/2	102805	BB-700-1
7/8	6-1/2	102806	BB-800-1
1	6-1/2	102807	BB-1000-2
1-1/8	6-1/2	102808	BB-1100
1-1/4	6-1/2	102809	BB-1200-1
1-3/8	6-1/2	102810	BB-1300
1-1/2	6-1/2	102811	BB-1500-2
1-5/8	6-1/2	102812	BB-1600
1-3/4	6-1/2	102813	BB-1700-1
2	6-1/2	102814	BB-2000-1
2-1/4	6-1/2	102815	BB-2200
2-1/2	6-1/2	102816	BB-2500-1
2-3/4	6-1/2	102817	BB-2700-1
3	6-1/2	102818	BB-3000-1
3-1/4	6-1/2	102819	BB-3200-2
3-1/2	6-1/2	102820	BB-3500-1
4	6-1/2	102821	BB-4000-1
4-1/2	6-1/2	102822	BB-4500
5	6-1/2	102823	BB-5000
5-1/2	6-1/2	102824	BB-5500
6	6-1/2	102825	BB-6000
7	6-1/2	102826	BB-7000

All sintered bars will finish to size shown.

ISOSTATIC INDUSTRIES INC., CHICAGO, IL

800-621-5500

POWDERED METAL BRONZE BEARINGS STOCK SIZES
(Discs - Circular Bearing Plates)

I.D.	O.D.	THICKNESS ± .010"	ITEM NO.	PART NO.
	3	1/4	103001	DD-3000
	3	3/8	103002	DD-3000-1
	4	1/4	103003	DD-4000
	5-5/8	†1/4	103004	DD-5602-1
	6	‡5/16	103005	DD-6000
	7	‡5/16	103006	DD-7001
	8	‡5/16	103007	DD-8000
	8	‡3/8	103008	DD-8000-3
1	3	1/4	103101	CD-3001
1	4	1/4	103102	CD-4001
2	4	1/4	103103	CD-4002
2	5-1/2	†1/4	103104	CD-5500
2-1/4	4-1/2	†1/4	103105	CD-4502
2-1/4	7	†1/4	103106	CD-7000-2
3	9	‡5/16	103107	CD-9001
4	6	‡5/16	103108	CD-6003

†Thickness ± .0035"

‡Thickness ± .005"

I.D. and O.D. will finish to dimensions shown.

RECTANGULAR PLATE STOCK



W	L	THICKNESS ± .010"	ITEM NO.	PART NO.
PLATE				
1/2	2-1/2	1/4	102901	PP-2500
2	8-1/8	1/4	102903	PP-8100-1
2	8-1/8	1/2	102904	PP-8100
3	12	1/4	102905	PP-12100
3	12	1/2	102906	PP-12100-1
3	12	3/4	102907	PP-12100-2
3	12	1	102908	PP-12100-3
5	6	1/8	102909	PP-6000
5	6	3/16	102910	PP-6000-1
5	6	1/4	102911	PP-6000-2
5	6	3/8	102912	PP-6000-4
5	6	1/2	102913	PP-6000-5
5	6	5/8	102914	PP-6000-6
5	6	3/4	102915	PP-6000-7
5	6	1	102916	PP-6000-8
5	8	1/8	102917	PP-8000-7
5	8	1/4	102919	PP-8000-1
5	8	1/2	102920	PP-8000-4
5	8	3/4	102921	PP-8000-5
5	8	1	102922	PP-8000-6
6	12	1/8	102923	PP-12000-6
6	12	3/16	102924	PP-12000-7
6	12	1/4	102925	PP-12000
6	12	3/8	102926	PP-12000-1
6	12	1/2	102927	PP-12000-2
6	12	5/8	102928	PP-12000-3
6	12	3/4	102929	PP-12000-4
6	12	1	102930	PP-12000-5

Width & length will finish to size shown.

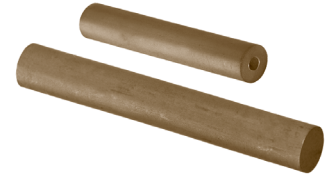
SUPER OILUBE BAR STOCK - 5" LENGTH SAE 863
18-22% COPPER - BALANCE IRON

I.D.	O.D.	LENGTH	ITEM NO.	PART NO.
CORED				
1/2	1	5	103301	SSC-1000
1/2	1-7/16	5	103302	SSC-1402
3/4	1-3/16	5	103304	SSC-1102
3/4	1-9/16	5	103305	SSC-1500
3/4	1-15/16	5	103306	SSC-1900
1	1-11/16	5	103310	SSC-1601
1	2-3/16	5	103311	SSC-2100
1-1/4	1-11/16	5	103312	SSC-1602
1-1/4	2-3/16	5	103313	SSC-2103
1-1/4	2-7/8	5	103314	SSC-2803
1-1/2	1-15/16	5	103316	SSC-1904
1-1/2	3-7/8	5	103319	SSC-3805
1-3/4	2-1/2	5	103320	SSC-2504
1-3/4	3	5	103321	SSC-3004
2	2-5/8	5	103323	SSC-2600
2	3	5	103324	SSC-3005
2-1/2	3-3/8	5	103327	SSC-3301
2-1/2	4-1/8	5	103328	SSC-4102
3	4-7/8	5	103331	SSC-4802

SOLID

3/8	2-1/2	103401	SSS-300
1/2	6-1/2	103402	SSS-500
5/8	5	103403	SSS-600
3/4	5	103404	SSS-700
7/8	5	103405	SSS-800
1	5	103406	SSS-1000
1-3/16	5	103407	SSS-1100
1-5/16	5	103408	SSS-1300
1-7/16	5	103409	SSS-1400
1-9/16	5	103410	SSS-1500
1-13/16	5	103411	SSS-1800
2-1/16	5	103412	SSS-2000
2-7/8	5	103413	SSS-2800

Bar stock will finish to sizes shown.

LOADS and SPEEDS

The normal load carrying capacity of OILUBE bearings is expressed as a PV factor (Pressure x Surface Velocity) where —

P = the load in psi on the projected bearing area (Bearing ID x Length).

V = surface velocity of the shaft in feet per minute (sfm)

$$PV = \frac{W}{LD} \times \frac{\pi DN}{12} = \frac{3.14 WN}{12L}$$

W = total load on bearing (pound)

L = bearing length (inches)

D = ID of bearing (inches)

N = shaft speed (rpm)

Normal Upper Limits of OILUBE Bearing Material

PV	Static (psi)	Dynamic (psi)	Velocity (sfm)
50,000	8,000	2,000	1,200

Normal Limits of Bearing Length

Material	Length to I.D. Ratio	Length to Wall Thickness Ratio
Oilube Bronze	4 to 1	24 to 1

For ratios greater than those shown above please contact us.

OILUBE BRONZE METRIC TOLERANCES

Nominal Sizes (mm)		Tolerances (in 0.001mm)	
Over	To	I.D.	O.D.
3	5	+20 +0	+40 +19
6	10	+30 +05	+40 +19
10	18	+30 +05	+50 +28
18	30	+30 +05	+60 +35
30	50	+40 +09	+70 +40
50	65	+40 +10	+83 +50

Overall Length

Up	to	40mm	± 0.12mm
40mm	to	55mm	± 0.19mm
55mm	to	76mm	± 0.25mm

Flange Outside diameter

Up	to	30mm	± 0.12mm
30mm	to	70mm	± 0.25mm

Flange Thickness

Up	to	3mm	± 0.07mm
3mm	to	5mm	± 0.13mm

Concentricity

Up	to	40mm	0.07mm
40mm	to	65mm	0.10mm
65mm	to	100mm	0.13mm
OVER	to	100mm	0.18mm

These manufacturing tolerances are the result of a compromise between ASTM-B438-73, and common ISO tolerances for G7-s7. Consider housing bores H7, assembly arbors n6, and shafts f7.

OILUBE MATERIAL SPECIFICATIONS

Composition %	Density (gm/cc)	Porosity (% by Volume)	K Strength Constant	Tensile Strength	Elongation (in 1"%)	Yield Strength PSI	Comparable Designations
Copper 87.5-90.5 Tin 9.5-10.5 Iron 1.0 max. Carbon 1.75 Other Elements 0.5	6.4-6.8	19 min.	26500	14000	1	11000	ASTM B-438-70 GR1 Type II MPIF CT-1000-K26 Mil-B-5687C Type I, Comp. A SAE-841

*Other sizes, tolerances, lubricants and materials are available on special orders.



I.D. (mm)	O.D. (mm)	Length (mm)	Item Number	Part Number
2	5	2	601003	AM-205-2
		3	601004	AM-205-3
3	6	4	601006	AM-306-4
		5	601007	AM-306-5
		6	601008	AM-306-6
		10	601009	AM-306-10
4	6	8	601012	AM-406-8
		10	601013	AM-406-10
		17	601014	AM-406-17
4	7	4	601015	AM-407-4
		8	601016	AM-407-8
		10	601017	AM-407-10
		12	601018	AM-407-12
4	8	4	601020	AM-408-4
		6	601021	AM-408-6
		8	601022	AM-408-8
		10	601023	AM-408-10
		12	601024	AM-408-12
5	7	7	601028	AM-507-7
5	8	5	601029	AM-508-5
		8	601030	AM-508-8
		10	601031	AM-508-10
		12	601032	AM-508-12
		15	601033	AM-508-15
		16	601034	AM-508-16
5	9	4	601035	AM-509-4
		5	601036	AM-509-5
		8	601037	AM-509-8
6	9	4	601047	AM-609-4
		6	601048	AM-609-6
		8	601049	AM-609-8
		10	601050	AM-609-10
		12	601051	AM-609-12
		15	601052	AM-609-15
6	10	4	601055	AM-610-4
		6	601056	AM-610-6
		10	601058	AM-610-10
		12	601059	AM-610-12
		14	601060	AM-610-14
		16	601061	AM-610-16
6	12	6	601062	AM-612-6
		8	601063	AM-612-8
		10	601064	AM-612-10
		11	601065	AM-612-11
		12	601066	AM-612-12
		15	601067	AM-612-15
		16	601068	AM-612-16
		25	601069	AM-612-25
		7	10	5
8	601073			AM-710-8
10	601074			AM-710-10
8	10	8	601080	AM-810-8
		10	601081	AM-810-10
8	11	8	601083	AM-811-8
		12	601084	AM-811-12
		16	601085	AM-811-16
		20	601086	AM-811-20
8	12	6	601087	AM-812-6
		8	601088	AM-812-8
		10	601089	AM-812-10
		12	601090	AM-812-12
		14	601091	AM-812-14

I.D. (mm)	O.D. (mm)	Length (mm)	Item Number	Part Number
8	12	16	601092	AM-812-16
		20	601093	AM-812-20
8	14	8	601097	AM-814-8
		12	601098	AM-814-12
		14	601099	AM-814-14
		16	601100	AM-814-16
		20	601101	AM-814-20
9	12	6	601105	AM-912-6
		10	601106	AM-912-10
		14	601107	AM-912-14
10	12	10	601113	AM-1012-10
		11	601114	AM-1012-11
		20	601115	AM-1012-20
10	13	10	601116	AM-1013-10
		12	601117	AM-1013-12
		16	601118	AM-1013-16
		18	601119	AM-1013-18
		20	601120	AM-1013-20
		25	601121	AM-1013-25
10	14	8	601122	AM-1014-8
		10	601123	AM-1014-10
		14	601124	AM-1014-14
		15	601125	AM-1014-15
		16	601126	AM-1014-16
		18	601127	AM-1014-18
10	15	20	601128	AM-1014-20
		25	601129	AM-1014-25
		10	601130	AM-1015-10
		16	601131	AM-1015-16
		20	601132	AM-1015-20
		25	601133	AM-1015-25
10	16	8	601134	AM-1016-8
		10	601135	AM-1016-10
		15	601136	AM-1016-15
		16	601137	AM-1016-16
		20	601138	AM-1016-20
		25	601139	AM-1016-25
12	14	30	601140	AM-1016-30
		9	601145	AM-1214-9
		12	601146	AM-1214-12
		14	601147	AM-1214-14
12	15	16	601148	AM-1214-16
		8	601149	AM-1215-8
		12	601150	AM-1215-12
		16	601153	AM-1215-16
		18	601154	AM-1215-18
		20	601155	AM-1215-20
12	16	25	601156	AM-1215-25
		8	601157	AM-1216-8
		12	601158	AM-1216-12
		15	601159	AM-1216-15
		16	601160	AM-1216-16
		20	601161	AM-1216-20
12	17	25	601162	AM-1216-25
		27	601163	AM-1216-27
		10	601165	AM-1217-10
		12	601166	AM-1217-12
		16	601167	AM-1217-16
		18	601168	AM-1217-18
12	18	20	601169	AM-1217-20
		25	601171	AM-1217-25
		8	601172	AM-1218-8
12	18	10	601173	AM-1218-10
		12	601174	AM-1218-12

*Other sizes, tolerances, lubricants and materials are available on special orders.



I.D. (mm)	I.D. (mm)	Length (mm)	Item Number	Part Number
12	18	16	601175	AM-1218-16
		18	601176	AM-1218-18
		20	601177	AM-1218-20
		25	601178	AM-1218-25
14	18	10	601184	AM-1418-10
		14	601185	AM-1418-14
		15	601186	AM-1418-15
		18	601187	AM-1418-18
		19	601188	AM-1418-19
		20	601189	AM-1418-20
		22	601190	AM-1418-22
		26	601191	AM-1418-26
		28	601192	AM-1418-28
14	20	10	601193	AM-1420-10
		12	601194	AM-1420-12
		14	601195	AM-1420-14
		15	601196	AM-1420-15
		18	601197	AM-1420-18
		20	601198	AM-1420-20
		22	601199	AM-1420-22
		25	601200	AM-1420-25
		28	601201	AM-1420-28
		15	19	10
15	601209			AM-1519-15
16	601210			AM-1519-16
20	601211			AM-1519-20
25	601212			AM-1519-25
32	601213			AM-1519-32
15	21	10	601223	AM-1521-10
		15	601224	AM-1521-15
		16	601225	AM-1521-16
		20	601226	AM-1521-20
		21	601227	AM-1521-21
		25	601228	AM-1521-25
		30	601229	AM-1521-30
		32	601230	AM-1521-32
		16	20	12
16	601244			AM-1620-16
20	601245			AM-1620-20
25	601246			AM-1620-25
28	601247			AM-1620-28
30	601248			AM-1620-30
32	601249			AM-1620-32
16	22	16	601252	AM-1622-16
		20	601253	AM-1622-20
		22	601254	AM-1622-22
		25	601255	AM-1622-25
		30	601256	AM-1622-30
		32	601257	AM-1622-32
17	22	17	601262	AM-1722-17
18	22	12	601264	AM-1822-12
		18	601265	AM-1822-18
		22	601266	AM-1822-22
		28	601267	AM-1822-28
		36	601269	AM-1822-36
18	24	12	601271	AM-1824-12
		17	601272	AM-1824-17
		18	601273	AM-1824-18
		22	601274	AM-1824-22
		24	601275	AM-1824-24
		25	601276	AM-1824-25
		28	601277	AM-1824-28
		30	601278	AM-1824-30
		36	601279	AM-1824-36

I.D. (mm)	I.D. (mm)	Length (mm)	Item Number	Part Number
18	25	22	601284	AM-1825-22
		28	601285	AM-1825-28
		36	601287	AM-1825-36
20	23	24	601291	AM-2023-24
20	24	16	601292	AM-2024-16
		20	601293	AM-2024-20
		24	601294	AM-2024-24
		25	601295	AM-2024-25
		27	601296	AM-2024-27
		30	601297	AM-2024-30
20	25	32	601298	AM-2024-32
		15	601299	AM-2025-15
		16	601300	AM-2025-16
		20	601301	AM-2025-20
		22	601302	AM-2025-22
		25	601303	AM-2025-25
20	26	28	601304	AM-2025-28
		30	601305	AM-2025-30
		32	601306	AM-2025-32
		15	601310	AM-2026-15
		16	601311	AM-2026-16
		20	601312	AM-2026-20
20	27	25	601313	AM-2026-25
		32	601316	AM-2026-32
		16	601318	AM-2027-16
		20	601319	AM-2027-20
20	28	25	601320	AM-2027-25
		32	601321	AM-2027-32
		16	601322	AM-2028-16
		20	601323	AM-2028-20
20	28	25	601324	AM-2028-25
		28	601325	AM-2028-28
		30	601326	AM-2028-30
		32	601327	AM-2028-32
		15	601338	AM-2227-15
		18	601340	AM-2227-18
22	27	20	601341	AM-2227-20
		22	601342	AM-2227-22
		25	601343	AM-2227-25
		28	601344	AM-2227-28
		36	601345	AM-2227-36
		18	601346	AM-2228-18
		20	601347	AM-2228-20
22	28	22	601348	AM-2228-22
		28	601349	AM-2228-28
		30	601350	AM-2228-30
		36	601351	AM-2228-36
		18	601353	AM-2229-18
		22	601355	AM-2229-22
22	29	28	601356	AM-2229-28
		36	601357	AM-2229-36
		20	601364	AM-2530-20
		25	601365	AM-2530-25
25	30	28	601366	AM-2530-28
		30	601367	AM-2530-30
		32	601368	AM-2530-32
		35	601369	AM-2530-35
		40	601370	AM-2530-40
		45	601371	AM-2530-45
		50	601372	AM-2530-50

*Other sizes, tolerances, lubricants and materials are available on special orders.



I.D. (mm)	O.D. (mm)	Length (mm)	Item Number	Part Number
25	32	20	601373	AM-2532-20
		25	601374	AM-2532-25
		30	601375	AM-2532-30
		32	601376	AM-2532-32
		35	601377	AM-2532-35
		40	601378	AM-2532-40
28	32	22	601390	AM-2832-22
		25	601391	AM-2832-25
		28	601392	AM-2832-28
		30	601393	AM-2832-30
		36	601394	AM-2832-36
		45	601395	AM-2832-45
28	33	22	601396	AM-2833-22
		28	601397	AM-2833-28
		36	601398	AM-2833-36
		45	601399	AM-2833-45
28	36	22	601401	AM-2836-22
		28	601402	AM-2836-28
		36	601403	AM-2836-36
		45	601404	AM-2836-45
30	35	15	601408	AM-3035-15
		20	601409	AM-3035-20
		25	601410	AM-3035-25
		30	601411	AM-3035-30
30	38	15	601415	AM-3038-15
		20	601416	AM-3038-20
		24	601417	AM-3038-24
		25	601418	AM-3038-25
		30	601419	AM-3038-30
		38	601420	AM-3038-38
32	38	20	601434	AM-3238-20
		25	601435	AM-3238-25
		28	601436	AM-3238-28
		32	601437	AM-3238-32
		40	601438	AM-3238-40
		50	601439	AM-3238-50
32	40	20	601440	AM-3240-20
		25	601441	AM-3240-25
		32	601442	AM-3240-32
		40	601443	AM-3240-40
		50	601444	AM-3240-50
		35	44	22
28	601459			AM-3544-28
35	601460			AM-3544-35
35	45			25
		35	601462	AM-3545-35
		40	601463	AM-3545-40
		45	601464	AM-3545-45
		50	601465	AM-3545-50
36	42	22	601468	AM-3642-22
		28	601469	AM-3642-28
		36	601470	AM-3642-36
		45	601471	AM-3642-45
36	45	22	601472	AM-3645-22
		28	601473	AM-3645-28
		36	601474	AM-3645-36
		45	601475	AM-3645-45
38	44	25	601477	AM-3844-25
		35	601478	AM-3844-35
		45	601479	AM-3844-45
40	46	25	601483	AM-4046-25
		30	601484	AM-4046-30
		32	601485	AM-4046-32
		40	601486	AM-4046-40
		50	601487	AM-4046-50
40	50	25	601488	AM-4050-25
		30	601489	AM-4050-30
		32	601490	AM-4050-32

I.D. (mm)	O.D. (mm)	Length (mm)	Item Number	Part Number		
40	50	35	601491	AM-4050-35		
		40	601492	AM-4050-40		
		50	601493	AM-4050-50		
		60	601494	AM-4050-60		
		80	601495	AM-4050-80		
		45	51	28	601497	AM-4551-28
35	601498			AM-4551-35		
36	601499			AM-4551-36		
45	601500			AM-4551-45		
55	601501			AM-4551-55		
56	601502			AM-4551-56		
45	55	35	601504	AM-4555-35		
		40	601505	AM-4555-40		
		45	601506	AM-4555-45		
		50	601507	AM-4555-50		
		55	601508	AM-4555-55		
		60	601509	AM-4555-60		
45	56	65	601510	AM-4555-65		
		28	601512	AM-4556-28		
		36	601513	AM-4556-36		
		45	601514	AM-4556-45		
		56	601515	AM-4556-56		
		50	56	32	601518	AM-5056-32
40	601519			AM-5056-40		
50	601520			AM-5056-50		
63	601522			AM-5056-63		
50	60			32	601523	AM-5060-32
				35	601524	AM-5060-35
		40	601525	AM-5060-40		
		50	601526	AM-5060-50		
		60	601527	AM-5060-60		
		63	601528	AM-5060-63		
55	65	40	601533	AM-5565-40		
		55	601534	AM-5565-55		
		60	601535	AM-5565-60		
		65	601536	AM-5565-65		
		70	601537	AM-5565-70		
		60	70	50	601543	AM-6070-50
60	601544			AM-6070-60		
90	601545			AM-6070-90		
120	601546			AM-6070-120		
60	72			50	601547	AM-6072-50
				60	601548	AM-6072-60
		63	601549	AM-6072-63		
		70	601550	AM-6072-70		
60	80	90	601553	AM-6080-90		
		120	601554	AM-6080-120		
63	70	40	601556	AM-6370-40		
		50	601557	AM-6370-50		
70	80	60	601564	AM-7080-60		
		90	601565	AM-7080-90		
		120	601566	AM-7080-120		
80	100	120	601583	AM-80100-120		
100	120	80	601590	AM-100120-80		
		120	601591	AM-100120-120		
110	125	120	601594	AM-110125-120		
125	150	120	601596	AM-125150-120		

*Other sizes, tolerances, lubricants and materials are available on special orders.



I.D. (mm)	O.D. (mm)	Length (mm)	Flange O.D. (mm)	Flange Thick (mm)	Item Number	Part Number
3	6	4	9	1.5	602003	FM-306-4
		6			602004	FM-306-6
		10			602005	FM-306-10
4	7	6	12	2	602008	FM-407-6
		10			602009	FM-407-10
4	8	4	12	2	602012	FM-408-4
		6			602013	FM-408-6
		8			602014	FM-408-8
		12			602015	FM-408-12
5	8	5	12	2	602017	FM-508-5
		6			602018	FM-508-6
6	9	6	12	1.5	602026	FM-609-6
		10			602027	FM-609-10
		12			602028	FM-609-12
6	9	5	14	1.5	602029	FM-609-5-1
		6			602030	FM-609-6-1
		10			602031	FM-609-10-1
		12			602032	FM-609-12-1
6	10	4	14	2	602035	FM-610-4
		6			602036	FM-610-6
		10			602037	FM-610-10
		14			602038	FM-610-14
		16			602039	FM-610-16
8	11	6	12	1.5	602045	FM-811-6
		10			602046	FM-811-10
8	11	6	14	1.5	602048	FM-811-6-1
		10			602049	FM-811-10-1
		12			602050	FM-811-12-1
8	12	6	16	2	602051	FM-812-6
		8			602052	FM-812-8
		12			602053	FM-812-12
		14			602054	FM-812-14
		16			602055	FM-812-16
9	14	6	19	2.5	602062	FM-914-6
		10			602063	FM-914-10
		14			602064	FM-914-14
10	13	6	16	1.5	602067	FM-1013-6
		8			602068	FM-1013-8
		10			602069	FM-1013-10
		12			602070	FM-1013-12
		16			602071	FM-1013-16
		20			602072	FM-1013-20
10	15	10	20	2.5	602078	FM-1015-10
		16			602079	FM-1015-16
		20			602080	FM-1015-20

I.D. (mm)	O.D. (mm)	Length (mm)	Flange O.D. (mm)	Flange Thick (mm)	Item Number	Part Number
10	16	8	20	3	602082	FM-1016-8
		10			602083	FM-1016-10
		16			602084	FM-1016-16
10	16	8	22	3	602087	FM-1016-8-1
		10			602088	FM-1016-10-1
		16			602090	FM-1016-16-1
12	15	7	18	1.5	602092	FM-1215-7
		12			602093	FM-1215-12
		16			602094	FM-1215-16
		20			602095	FM-1215-20
12	16	12	20	2	602098	FM-1216-12
		16			602099	FM-1216-16
		25			602100	FM-1216-25
12	17	12	22	2.5	602102	FM-1217-12
		16			602103	FM-1217-16
		20			602104	FM-1217-20
		25			602105	FM-1217-25
12	18	8	24	3	602111	FM-1218-8
		10			602112	FM-1218-10
		12			602113	FM-1218-12
		16			602114	FM-1218-16
		20			602115	FM-1218-20
14	18	12	22	2	602119	FM-1418-12
		14			602120	FM-1418-14
		18			602121	FM-1418-18
		20			602122	FM-1418-20
		22			602123	FM-1418-22
14	20	10	26	3	602128	FM-1420-10
		14			602129	FM-1420-14
		18			602130	FM-1420-18
		22			602132	FM-1420-22
15	19	15	23	2	602135	FM-1519-15
		16			602136	FM-1519-16
		20			602137	FM-1519-20
		25			602138	FM-1519-25
15	21	10	27	3	602142	FM-1521-10
		15			602143	FM-1521-15
		16			602144	FM-1521-16
		20			602145	FM-1521-20
		25			602146	FM-1521-25
		32			602147	FM-1521-32
15	22	12	28	3	602148	FM-1522-12
		15			602149	FM-1522-15
16	20	12	24	2	602154	FM-1620-12

*Other sizes, tolerances, lubricants and materials are available on special orders.



I.D. (mm)	O.D. (mm)	Length (mm)	Flange		Item Number	Part Number
			O.D. (mm)	Thick (mm)		
16	20	16	24	2	602155	FM-1620-16
		20			602156	FM-1620-20
		25			602157	FM-1620-25
16	22	12	28	3	602158	FM-1622-12
		16			602159	FM-1622-16
		20			602160	FM-1622-20
		25			602161	FM-1622-25
		32			602162	FM-1622-32
18	22	18	26	2	602169	FM-1822-18
		20			602170	FM-1822-20
		22			602171	FM-1822-22
18	24	12	30	3	602175	FM-1824-12
		18			602176	FM-1824-18
		22			602177	FM-1824-22
		28			602178	FM-1824-28
20	24	12	28	2	602187	FM-2024-12
		16			602188	FM-2024-16
		20			602189	FM-2024-20
		25			602190	FM-2024-25
20	26	15	32	3	602193	FM-2026-15
		16			602194	FM-2026-16
		20			602195	FM-2026-20
		25			602196	FM-2026-25
		30			602197	FM-2026-30
22	27	18	32	2.5	602206	FM-2227-18
		22			602207	FM-2227-22
		28			602208	FM-2227-28
		22			28	15
16	602210		FM-2228-16			
20	602211		FM-2228-20			
25	602212		FM-2228-25			
30	602213		FM-2228-30			
22	29	18	36	3.5	602214	FM-2229-18
		22			602215	FM-2229-22
		28			602216	FM-2229-28
		36			602217	FM-2229-36
25	30	20	35	2.5	602222	FM-2530-20
		25			602223	FM-2530-25
		30			602224	FM-2530-30
		32			602225	FM-2530-32
25	32	20	39	3.5	602228	FM-2532-20
		25			602229	FM-2532-25
		30			602230	FM-2532-30
		32			602231	FM-2532-32

I.D. (mm)	O.D. (mm)	Length (mm)	Flange		Item Number	Part Number
			O.D. (mm)	Thick (mm)		
28	33	22	38	2.5	602242	FM-2833-22
		28			602243	FM-2833-28
		36			602244	FM-2833-36
28	36	22	44	4	602245	FM-2836-22
		28			602246	FM-2836-28
		36			602247	FM-2836-36
30	38	20	46	4	602256	FM-3038-20
		25			602257	FM-3038-25
		30			602258	FM-3038-30
32	38	20	44	3	602264	FM-3238-20
		25			602265	FM-3238-25
		32			602266	FM-3238-32
32	40	20	48	4	602269	FM-3240-20
		25			602270	FM-3240-25
		30			602271	FM-3240-30
		32			602272	FM-3240-32
36	42	22	48	3	602279	FM-3642-22
		28			602280	FM-3642-28
		36			602281	FM-3642-36
36	45	22	54	4.5	602282	FM-3645-22
		28			602283	FM-3645-28
		36			602284	FM-3645-36
40	46	25	52	3	602285	FM-4046-25
		32			602286	FM-4046-32
		40			602287	FM-4046-40
40	50	30	60	5	602288	FM-4050-30
		32			602289	FM-4050-32
		40			602290	FM-4050-40
45	51	28	57	3	602296	FM-4551-28
		36			602297	FM-4551-36
		45			602298	FM-4551-45
45	56	28	67	5.5	602304	FM-4556-28
		36			602305	FM-4556-36
		45			602306	FM-4556-45
50	56	30	62	3	602307	FM-5056-30
		32			602308	FM-5056-32
		40			602309	FM-5056-40
50	60	50	70	5	602310	FM-5056-50
		32			602311	FM-5060-32
		35			602312	FM-5060-35
50	60	40	70	5	602313	FM-5060-40
		50			602314	FM-5060-50
		60			70	50
60	602320		FM-6070-60			

*Other sizes, tolerances, lubricants and materials are available on special orders.

Isostatic Century® Cast Bronze Bearings

SPECIAL SIZES & ALLOYS

Our Cast Bearings are made to exacting dimensions and a full range of bronze bearing alloys is available to suit your requirements. Orders placed in quantities from one to thousands are handled economically and fast.

Graphiting

Graphite lubrication on the ID face of the bearing will enable you to obtain long bearing life both at high operating temperatures, and in applications lacking a supplemental lubrication. Graphiting is accomplished by grooving the I.D. and then pressing Graphite into the cavities under extremely high pressure.

When using a Graphite lubrication bearing, an allowance of .001 " to .002" additional clearance is suggested. This extra clearance can be obtained by ordering the bearing with a larger I.D. or by reaming. These bearings should be lubricated prior to assembly.

Oil and Grease Grooves



SINGLE LOOP

Johnson A Boston Gear III
 Bunting 1 Buckeye A
 Randall A



FIGURE EIGHT

Johnson B Boston Gear IV
 Bunting 4 Buckeye D
 Randall B

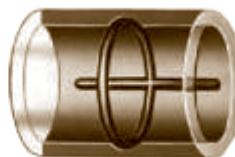

ONE STRAIGHT and ONE CIRCULAR

Johnson C Boston Gear V
 Bunting 3 Buckeye C



DOUBLE LOOP

Johnson D Boston Gear VI
 Bunting 2 Buckeye B
 Randall D



DOUBLE FIGURE EIGHT

Johnson E Boston Gear VII
 Bunting 5 Buckeye E
 Randall E



R.H. and L.H. SPIRAL

Johnson F Boston Gear VIII
 Bunting 11 Buckeye F
 Randall F



STRAIGHT GROOVE

Johnson G
 Randall G
 Boston Gear I

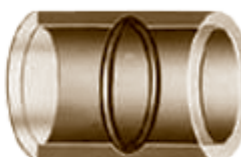

CIRCULAR GROOVE

Johnson H
 Randall H
 Boston Gear II

AIDS IN GROOVE SELECTION

Groove selection can be influenced by many things such as operating environment, type of lubricant, supplemental lubrication feed system, load etc.. The following information is intended as a guide. Consideration must be given to all factors.

Boundary lubrication is where none of the load is supported by the lubricant. Bearings which are only periodically lubricated will at some time operate under these conditions. Speeds which are 10 s.f.m. or less will cause boundary lubrication.

Suggested Grooving:
 Double loop – Double figure 8

Mixed film lubrication. Load is partially supported by lubrication. Speeds from 10 to 25 s.f.m. will induce this condition. Most cast bronze bearing applications are in this category.

Suggested Grooving:
 Straight. – Good for long bearings. It should be located in the unloaded area of the bearing. Circular – is used when the direction of load varies and a pressure fed lubricant system is present.

Straight Circular. – is applied in cases where the direction of the load varies and the lubricant is not pressure fed.

Full film lubrication. The load is separated from the bearing by a film of lubricant. A minimum speed of 25 s.f.m. will generally be needed.

Suggested Grooving:
 The same types of grooving used in mixed film will work in the full film application.

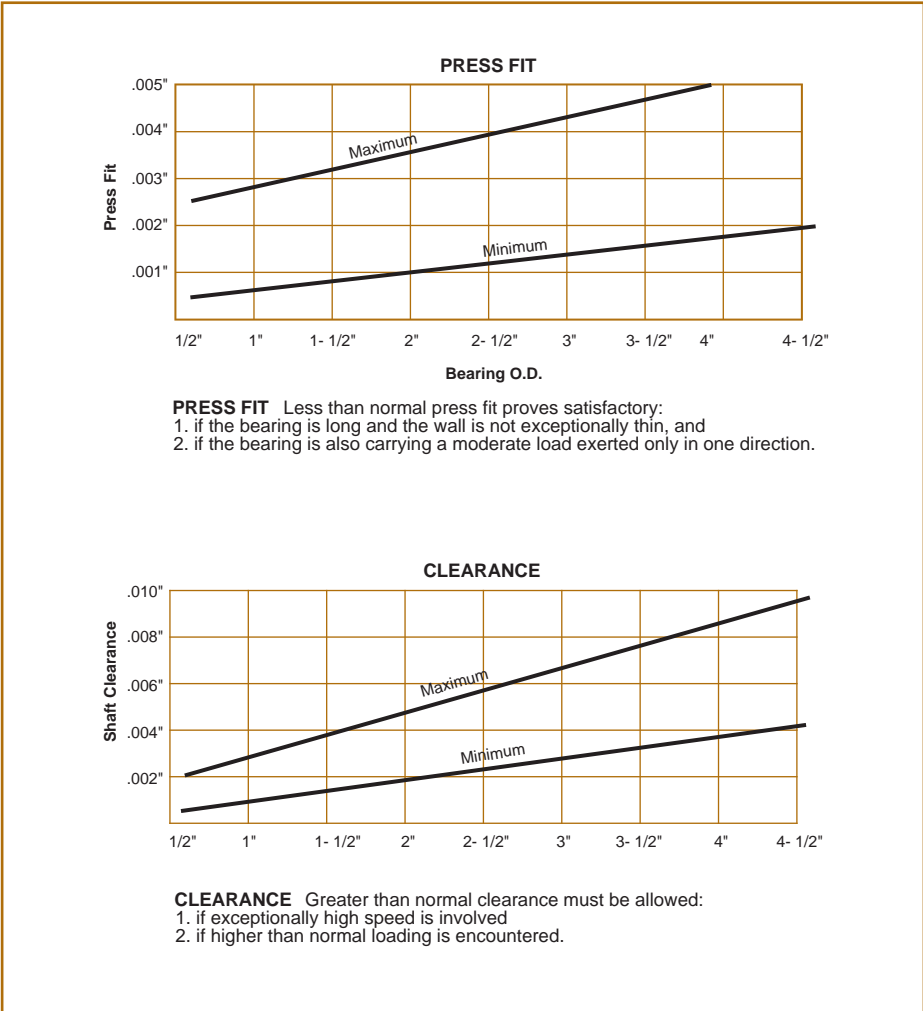

CENTURY CAST BRONZE MATERIAL SPECIFICATIONS

Chemical Composition	Tensile Strength	Yield Strength	Elongation in 2"	Brinell Hardness	Equivalent Specifications
Copper 83% Tin 7% Lead 7% Zinc 3%	35000 P.S.I.	20000 P.S.I.	10%	72	CDA 932 SAE 660 ASTM B505 ASTM B144-52-3B

Typical Properties - not to be used for specification purposes

TOLERANCES

I.D. 3" or less	± .001"
Over 3"	± .0015"
O.D. 3" or less	+ .002" to .003"
Over 3"	+ .003" to .005"
Length	± .005"
Concentricity	.003" T.I.R.



I.D.	O.D.	LENGTH	ITEM NO.	PART NO.
3/16	5/16	1/2	104004	CB-0305-04
		3/4	104005	CB-0305-06
		1	104006	CB-0305-08
1/4	3/8	1/4	104007	CB-0406-02
		3/8	104008	CB-0406-03
		1/2	104009	CB-0406-04
		3/4	104010	CB-0406-06
		1	104011	CB-0406-08
		1-1/4	104012	CB-0406-10
1/4	7/16	3/4	304010	M46-6
		3/4	104013	CB-0407-06
		1	104014	CB-0407-08
		1-1/4	104015	CB-0407-10
5/16	7/16	3/8	104016	CB-0507-03
		1/2	104017	CB-0507-04
		3/4	104018	CB-0507-06
		1	104019	CB-0507-08
		1-1/4	104020	CB-0507-10
5/16	1/2	3/4	104021	CB-0508-06
		1	104022	CB-0508-08
		1-1/4	104023	CB-0508-10
3/8	1/2	3/8	104024	CB-0608-03
		1/2	104025	CB-0608-04
		3/4	104026	CB-0608-06
		1	104027	CB-0608-08
		1-1/4	104028	CB-0608-10
		1-1/2	104029	CB-0608-12
3/8	9/16	3/4	104030	CB-0609-06
		1	104031	CB-0609-08
		1-1/4	104032	CB-0609-10
3/8	5/8	3/4	104034	CB-0610-06
		1	104035	CB-0610-08
		1-1/4	104036	CB-0610-10
		1-1/2	104037	CB-0610-12
		1	304035	M610-8
7/16	9/16	1	104038	CB-0709-08
		1-1/4	104039	CB-0709-10
		1-1/2	104040	CB-0709-12
		1-3/4	104042	CB-0709-14
		2	104043	CB-0709-16
7/16	5/8	1	104044	CB-0710-08
		1-1/4	104045	CB-0710-10
		1-1/2	104046	CB-0710-12
		2	104047	CB-0710-16
7/16	11/16	1-1/2	104048	CB-0711-12
7/16	3/4	1	104049	CB-0712-08
		1-1/4	104050	CB-0712-10
		1-1/2	104051	CB-0712-12
7/16	13/16	1-1/2	104052	CB-0713-12
1/2	5/8	1/2	104053	CB-0810-04
		5/8	104054	CB-0810-05

I.D.	O.D.	LENGTH	ITEM NO.	PART NO.		
1/2	5/8	3/4	104055	CB-0810-06		
		7/8	104056	CB-0810-07		
		1	104057	CB-0810-08		
		1-1/4	104058	CB-0810-10		
		1-3/8	104059	CB-0810-11		
		1-1/2	104060	CB-0810-12		
		1-3/4	104061	CB-0810-14		
		2	104062	CB-0810-16		
		2-1/4	104063	CB-0810-18		
		1/2	11/16	3/4	104064	CB-0811-06
1/2	3/4	1	104065	CB-0811-08		
		1-1/4	104066	CB-0811-10		
		1-1/2	104067	CB-0811-12		
		1-3/4	104068	CB-0811-14		
		2	104069	CB-0811-16		
		2-1/4	104070	CB-0811-18		
		2-1/2	104071	CB-0811-20		
1/2	3/4	3/4	104073	CB-0812-06		
1/2	3/4	1	104074	CB-0812-08		
		1-1/4	104075	CB-0812-10		
		1-1/2	104076	CB-0812-12		
		1-3/4	104078	CB-0812-14		
		2	104079	CB-0812-16		
		2-1/4	104080	CB-0812-18		
		2-1/2	104081	CB-0812-20		
		2-3/4	104082	CB-0812-22		
		1	304074	M812-8		
1/2	13/16	1	104083	CB-0813-08		
1/2	7/8	1-1/2	104084	CB-0813-12		
		2-1/4	104085	CB-0813-18		
1/2	7/8	1	104086	CB-0814-08		
1/2	1	1-1/4	104087	CB-0814-10		
		1-1/2	104088	CB-0814-12		
		1-3/4	104089	CB-0814-14		
		2	104090	CB-0814-16		
1/2	1	1	104091	CB-0816-08		
9/16	11/16	1-1/2	104092	CB-0816-12		
		2	104093	CB-0816-16		
		2-1/4	104094	CB-0816-18		
9/16	11/16	1	104095	CB-0911-08		
		1-1/4	104096	CB-0911-10		
		1-1/2	104097	CB-0911-12		
		1-3/4	104099	CB-0911-14		
		2	104100	CB-0911-16		
		2-1/4	104101	CB-0911-18		
		2-1/2	104102	CB-0911-20		
9/16	3/4	1	104103	CB-0912-08		
		1-1/4	104104	CB-0912-10		
		1-1/2	104105	CB-0912-12		
		1-3/4	104107	CB-0912-14		
		2	104108	CB-0912-16		
		2-1/4	104110	CB-0912-18		

I.D.	O.D.	LENGTH	ITEM NO.	PART NO.
9/16	3/4	2-1/2	104111	CB-0912-20
9/16	13/16	1	104112	CB-0913-08
		1-1/4	104113	CB-0913-10
		1-1/2	104114	CB-0913-12
		1-3/4	104115	CB-0913-14
		2	104116	CB-0913-16
		2-1/2	104118	CB-0913-20
9/16	7/8	1	104119	CB-0914-08
		1-1/2	104120	CB-0914-12
		2	104121	CB-0914-16
5/8	3/4	1/2	104124	CB-1012-04
		3/4	104125	CB-1012-06
		1	104126	CB-1012-08
		1-1/8	104127	CB-1012-09
		1-1/4	104128	CB-1012-10
		1-1/2	104130	CB-1012-12
		1-3/4	104131	CB-1012-14
		2	104133	CB-1012-16
		2-1/4	104134	CB-1012-18
		2-1/2	104135	CB-1012-20
5/8	13/16	3	104136	CB-1012-24
		1	304126	M1012-8
		1	104137	CB-1013-08
		1-1/4	104138	CB-1013-10
		1-1/2	104140	CB-1013-12
		1-3/4	104141	CB-1013-14
5/8	7/8	2	104143	CB-1013-16
		2-1/4	104144	CB-1013-18
		2-1/2	104145	CB-1013-20
		1/2	104148	CB-1014-04
		3/4	104149	CB-1014-06
5/8	15/16	1	104150	CB-1014-08
		1-1/8	104151	CB-1014-09
		1-1/4	104153	CB-1014-10
		1-1/2	104155	CB-1014-12
		1-3/4	104156	CB-1014-14
		2	104159	CB-1014-16
		2-1/4	104160	CB-1014-18
5/8	1	2-1/2	104162	CB-1014-20
		3	104163	CB-1014-24
		1	104165	CB-1015-08
		1-1/2	104166	CB-1015-12
5/8	1	2	104167	CB-1015-16
		2-1/2	104168	CB-1015-20
		1	104169	CB-1016-08
		1-1/2	104170	CB-1016-12
5/8	1-1/8	2	104171	CB-1016-16
		2-1/4	104172	CB-1016-18
		2-1/2	104173	CB-1016-20
		3	104174	CB-1016-24
		1-1/2	104175	CB-1018-12
5/8	1-1/8	2	104176	CB-1018-16

*Other sizes, tolerances, lubricants and materials are available on special orders.



I.D.	O.D.	LENGTH	ITEM NO.	PART NO.	I.D.	O.D.	LENGTH	ITEM NO.	PART NO.	I.D.	O.D.	LENGTH	ITEM NO.	PART NO.
5/8	1-1/8	2-1/4	104177	CB-1018-18	3/4	1	1-7/8	104235	CB-1216-15	7/8	1-1/16	1-1/2	104306	CB-1417-12
		3	104178	CB-1018-24			2	104237	CB-1216-16			1-3/4	104307	CB-1417-14
11/16	13/16	1	104179	CB-1113-08			2-1/8	104238	CB-1216-17			2	104308	CB-1417-16
		1-1/4	104180	CB-1113-10			2-1/4	104239	CB-1216-18			2-1/4	104309	CB-1417-18
		1-1/2	104181	CB-1113-12			2-1/2	104241	CB-1216-20			2-1/2	104310	CB-1417-20
		1-3/4	104182	CB-1113-14			2-3/4	104242	CB-1216-22			3	104312	CB-1417-24
		2	104183	CB-1113-16			3	104243	CB-1216-24					
		2-1/2	104185	CB-1113-20			3-1/2	104244	CB-1216-28	7/8	1-1/8	3/4	104313	CB-1418-06
11/16	7/8	1	104186	CB-1114-08			1	304229	M1216-8			1	104314	CB-1418-08
		1-1/4	104187	CB-1114-10	3/4	1-1/16	1	104245	CB-1217-08			1-1/4	104315	CB-1418-10
		1-1/2	104188	CB-1114-12			1-1/2	104246	CB-1217-12			1-3/8	104316	CB-1418-11
		1-3/4	104189	CB-1114-14			2	104247	CB-1217-16			1-1/2	104317	CB-1418-12
		2	104190	CB-1114-16			2-1/4	104248	CB-1217-18			1-3/4	104318	CB-1418-14
		2-1/4	104191	CB-1114-18			2-1/2	104249	CB-1217-20			2	104320	CB-1418-16
		2-1/2	104192	CB-1114-20			3	104250	CB-1217-24			2-1/4	104322	CB-1418-18
11/16	15/16	1	104193	CB-1115-08	3/4	1-1/8	1	104251	CB-1218-08			2-1/2	104323	CB-1418-20
		1-1/4	104194	CB-1115-10			1-1/2	104252	CB-1218-12			3	104324	CB-1418-24
		1-1/2	104195	CB-1115-12			2	104253	CB-1218-16			3-1/4	104325	CB-1418-26
		1-3/4	104196	CB-1115-14			2-1/4	104254	CB-1218-18			3-1/2	104326	CB-1418-28
		2	104197	CB-1115-16			2-1/2	104255	CB-1218-20	7/8	1-3/16	1	104327	CB-1419-08
		2-1/2	104199	CB-1115-20			3	104256	CB-1218-24			1-1/4	104328	CB-1419-10
11/16	1	1-1/4	104201	CB-1116-10	3/4	1-3/16	1-1/2	104258	CB-1219-12			1-1/2	104329	CB-1419-12
		2-1/4	104204	CB-1116-18			2	104259	CB-1219-16			2	104330	CB-1419-16
		2-1/2	104205	CB-1116-20	3/4	1-1/4	1-3/4	104263	CB-1220-14			2-1/2	104331	CB-1419-20
3/4	7/8	3/4	104207	CB-1214-06			2	104264	CB-1220-16			3	104333	CB-1419-24
		1	104208	CB-1214-08			2-1/4	104265	CB-1220-18	7/8	1-1/4	1-1/2	104334	CB-1420-12
		1-1/4	104209	CB-1214-10			2-1/2	104266	CB-1220-20			1-3/4	104335	CB-1420-14
		1-1/2	104210	CB-1214-12			3	104267	CB-1220-24			2	104336	CB-1420-16
		1-3/4	104211	CB-1214-14								2-1/4	104337	CB-1420-18
		2	104212	CB-1214-16	13/16	15/16	1	104268	CB-1315-08			2-1/2	104338	CB-1420-20
		2-1/4	104213	CB-1214-18			1-1/2	104271	CB-1315-12			3	104339	CB-1420-24
		2-1/2	104214	CB-1214-20			2	104272	CB-1315-16			3-1/2	104340	CB-1420-28
		3/4	304207	M1214-6	13/16	1	1-1/2	104274	CB-1316-12			4	104341	CB-1420-32
3/4	15/16	1	104215	CB-1215-08			1-3/4	104275	CB-1316-14	7/8	1-3/8	1-1/2	104344	CB-1422-12
		1-1/4	104217	CB-1215-10			2	104276	CB-1316-16			1-3/4	104345	CB-1422-14
		1-3/8	104218	CB-1215-11			2-1/2	104277	CB-1316-20			2	104346	CB-1422-16
		1-1/2	104219	CB-1215-12	13/16	1-1/16	1-1/2	104279	CB-1317-12			2-1/2	104347	CB-1422-20
		1-3/4	104220	CB-1215-14			2	104280	CB-1317-16			3	104348	CB-1422-24
		2	104221	CB-1215-16			2-1/2	104281	CB-1317-20	15/16	1-1/8	1-1/2	104351	CB-1518-12
		2-1/4	104222	CB-1215-18			2-3/4	104282	CB-1317-22			2	104352	CB-1518-16
		2-1/2	104223	CB-1215-20			3	104283	CB-1317-24			2-1/2	104354	CB-1518-20
		2-3/4	104224	CB-1215-22	13/16	1-1/8	1-1/2	104284	CB-1318-12	15/16	1-3/16	1-1/4	104355	CB-1519-10
		3	104225	CB-1215-24			2	104285	CB-1318-16			1-1/2	104357	CB-1519-12
3/4	1	1/2	104226	CB-1216-04	13/16	1-3/16	2-1/2	104287	CB-1319-20			2	104358	CB-1519-16
		3/4	104227	CB-1216-06			3	104288	CB-1319-24			2-1/4	104359	CB-1519-18
		7/8	104228	CB-1216-07	7/8	1	1	104296	CB-1416-08			3	104361	CB-1519-24
		1	104229	CB-1216-08			1-1/4	104297	CB-1416-10	15/16	1-1/4	1	104362	CB-1520-08
		1-1/8	104230	CB-1216-09			1-3/8	104298	CB-1416-11			1-1/2	104363	CB-1520-12
		1-1/4	104231	CB-1216-10			1-1/2	104299	CB-1416-12			2	104364	CB-1520-16
		1-3/8	104232	CB-1216-11			1-5/8	104300	CB-1416-13			2-1/2	104366	CB-1520-20
		1-1/2	104233	CB-1216-12			2	104301	CB-1416-16			2-3/4	104367	CB-1520-22
		1-3/4	104234	CB-1216-14	7/8	1-1/16	1	104303	CB-1417-08	15/16	1-5/16	1-1/2	104368	CB-1521-12
							1-1/4	104304	CB-1417-10			2	104370	CB-1521-16
												3	104372	CB-1521-24

*Other sizes, tolerances, lubricants and materials are available on special orders.



I.D.	O.D.	LENGTH	ITEM NO.	PART NO.		
1	1-1/8	1	104373	CB-1618-08		
		1-3/8	104374	CB-1618-11		
		1-1/2	104375	CB-1618-12		
		1-3/4	104376	CB-1618-14		
		2	104377	CB-1618-18		
		2-1/2	104378	CB-1618-20		
1	1-3/16	7/8	104379	CB-1619-07		
		1	105031	CB-1619-08		
		1-1/4	104380	CB-1619-10		
		1-1/2	104381	CB-1619-12		
		1-3/4	104383	CB-1619-14		
		2	104384	CB-1619-16		
		2-1/2	104386	CB-1619-20		
		1	1-1/4	3/4	104387	CB-1620-06
				1	104388	CB-1620-08
				1-1/8	104389	CB-1620-09
1-1/4	104390			CB-1620-10		
1-3/8	104391			CB-1620-11		
1-1/2	104392			CB-1620-12		
1-5/8	104393			CB-1620-13		
1-3/4	104394			CB-1620-14		
1-7/8	105032			CB-1620-15		
2	104395			CB-1620-16		
2-1/4	104397			CB-1620-18		
2-1/2	104398			CB-1620-20		
2-3/4	104399			CB-1620-22		
3	104400			CB-1620-24		
3-1/2	104401			CB-1620-28		
3-3/4	104402			CB-1620-30		
4	104403			CB-1620-32		
4-1/2	104404			CB-1620-36		
1	1-5/16			1-1/2	104405	CB-1621-12
				2	104406	CB-1621-16
		2-1/4	104407	CB-1621-18		
		2-1/2	104408	CB-1621-20		
		3	104409	CB-1621-24		
		3-1/2	104410	CB-1621-28		
		3-3/4	104411	CB-1621-30		
		1	1-3/8	1	104412	CB-1622-08
1-1/4	104413			CB-1622-10		
1-1/2	104414			CB-1622-12		
1-3/4	104415			CB-1622-14		
2	104416			CB-1622-16		
2-1/2	104417			CB-1622-20		
2-3/4	104418			CB-1622-22		
3	104419			CB-1622-24		
3-1/4	104420			CB-1622-26		
3-1/2	104421			CB-1622-28		
4	104422			CB-1622-32		
4-1/2	104423			CB-1622-36		
1	1-1/2			1-1/2	104424	CB-1624-12
				1-3/4	104425	CB-1624-14
		2	104426	CB-1624-16		
		2-1/2	104427	CB-1624-20		

I.D.	O.D.	LENGTH	ITEM NO.	PART NO.		
1	1-1/2	3	104428	CB-1624-24		
		4	104429	CB-1624-32		
1	1-5/8	2	104431	CB-1626-16		
		2-1/2	104432	CB-1626-20		
		3	104433	CB-1626-24		
		3-1/2	104434	CB-1626-28		
		3	304433	M1626-24		
		1	1-3/4	6-1/2	104436	CB-1628-52
1	2	3	104437	CB-1632-24		
		6-1/2	104440	CB-1632-52		
1-1/16	1-5/16	1-1/2	104442	CB-1721-12		
		2	104443	CB-1721-16		
		2-1/2	104444	CB-1721-20		
		3	104445	CB-1721-24		
		3-1/2	104446	CB-1721-28		
		1-1/16	1-3/8	1	104447	CB-1722-08
1-1/16	1-7/16	2	104448	CB-1722-16		
		2-1/2	104449	CB-1722-20		
1-1/16	1-7/16	2-1/2	104450	CB-1723-20		
		3	104451	CB-1723-24		
		4	104453	CB-1723-32		
		1-1/8	1-1/4	1-1/2	104457	CB-1820-12
1-1/8	1-1/4	1-3/4	104459	CB-1820-14		
		2	104460	CB-1820-16		
1-1/8	1-5/16	2-1/4	104462	CB-1821-18		
		2-1/2	104463	CB-1821-20		
1-1/8	1-3/8	1	104464	CB-1822-08		
		1-1/4	104465	CB-1822-10		
		1-1/2	104466	CB-1822-12		
		1-3/4	104467	CB-1822-14		
		2	104468	CB-1822-16		
		2-1/4	104470	CB-1822-18		
		2-1/2	104471	CB-1822-20		
		3	104472	CB-1822-24		
		3-1/4	104473	CB-1822-26		
		3-1/2	104474	CB-1822-28		
4	104475	CB-1822-32				
1-1/8	1-7/16	1-1/2	104478	CB-1823-12		
		2-1/2	104479	CB-1823-20		
		3	104480	CB-1823-24		
		3-1/2	104481	CB-1823-28		
		1-1/8	1-1/2	1-1/2	104482	CB-1824-12
		2	104483	CB-1824-16		
1-1/8	1-1/2	2-1/2	104484	CB-1824-20		
		3	104485	CB-1824-24		
		3-1/2	104486	CB-1824-28		
		4	104487	CB-1824-32		
		1-1/8	1-5/8	1-3/4	104489	CB-1826-14
		2	104490	CB-1826-16		
		2-1/2	104491	CB-1826-20		
		3	104492	CB-1826-24		
1-1/8	1-5/8	3-1/2	104493	CB-1826-28		
		4	104494	CB-1826-32		
		4-1/2	104495	CB-1826-36		
		1-1/8	1-7/8	6-1/2	104496	CB-1830-52
1-1/8	2	3	104497	CB-1832-24		
		5-1/2	104498	CB-1832-44		

I.D.	O.D.	LENGTH	ITEM NO.	PART NO.
1-3/16	1-3/8	1-3/4	104499	CB-1922-14
		2	104500	CB-1922-16
		2-1/2	104501	CB-1922-20
1-3/16	1-7/16	1-1/4	104502	CB-1923-10
		1-1/2	104503	CB-1923-12
		2	104504	CB-1923-16
		2-1/2	104505	CB-1923-20
		3	104507	CB-1923-24
		3-1/2	104508	CB-1923-28
1-3/16	1-1/2	2	104509	CB-1924-16
		3	104510	CB-1924-24
		4	104511	CB-1924-32
		1-3/16	1-9/16	1-1/2
1-3/16	1-9/16	2-1/2	104513	CB-1925-20
		3	104514	CB-1925-24
		3-1/2	104515	CB-1925-28
1-3/16	1-5/8	2	104516	CB-1926-16
		2-1/2	104517	CB-1926-20
		3	104518	CB-1926-24
1-3/16	1-11/16	2	104519	CB-1927-16
		2-1/2	104520	CB-1927-20
		3	104521	CB-1927-24
		3-1/2	104522	CB-1927-28
1-1/4	1-7/16	2	105033	CB-2023-16
		2-1/2	104526	CB-2023-20
		3	104527	CB-2023-24
1-1/4	1-1/2	1	104528	CB-2024-08
		1-1/8	104529	CB-2024-09
		1-1/4	104530	CB-2024-10
		1-3/8	104531	CB-2024-11
		1-1/2	104532	CB-2024-12
		1-5/8	104533	CB-2024-13
		1-3/4	104534	CB-2024-14
		2	104536	CB-2024-16
		2-1/4	104538	CB-2024-18
		2-1/2	104539	CB-2024-20
		2-3/4	104540	CB-2024-22
		3	104541	CB-2024-24
		3-1/4	104542	CB-2024-26
		3-1/2	104543	CB-2024-28
4	104545	CB-2024-32		
4-1/4	104546	CB-2024-34		
4-1/2	104547	CB-2024-36		
5	104548	CB-2024-40		
5-1/2	104549	CB-2024-44		
1-1/4	1-9/16	2	104550	CB-2025-16
		2-1/2	104552	CB-2025-20
		3	104554	CB-2025-24
		3-1/2	104555	CB-2025-28
		3-3/4	104556	CB-2025-30
		1-1/4	1-5/8	1-3/4
1-1/4	1-5/8	2	104559	CB-2026-16
		2-1/2	104560	CB-2026-20

*Other sizes, tolerances, lubricants and materials are available on special orders.



I.D.	O.D.	LENGTH	ITEM NO.	PART NO.	I.D.	O.D.	LENGTH	ITEM NO.	PART NO.	I.D.	O.D.	LENGTH	ITEM NO.	PART NO.		
1-1/4	1-5/8	3	104561	CB-2026-24	1-3/8	1-5/8	3-1/4	104620	CB-2226-26	1-1/2	1-3/4	1-1/2	104682	CB-2428-12		
		3-1/4	104562	CB-2026-26			3-1/2	104621	CB-2226-28			1-3/4	104683	CB-2428-14		
		3-1/2	104563	CB-2026-28			4	104622	CB-2226-32			2	104684	CB-2428-16		
		4	104564	CB-2026-32			4-1/2	104623	CB-2226-36			2-1/4	104686	CB-2428-18		
		4-1/2	104566	CB-2026-36			1-3/8	1-11/16	3-1/2			104624	CB-2227-28	2-1/2	104687	CB-2428-20
		4-3/4	104567	CB-2026-38			1-3/8	1-3/4	2			104625	CB-2228-16	3	104688	CB-2428-24
1-1/4	1-11/16	2	104568	CB-2027-16	2-1/4		104626	CB-2228-18	3-1/2	104689	CB-2428-28					
		2-1/2	104569	CB-2027-20	2-1/2		104627	CB-2228-20	4	104690	CB-2428-32					
		3-1/4	104570	CB-2027-26	3		104628	CB-2228-24	4-1/2	104691	CB-2428-36					
		3-1/2	104571	CB-2027-28	3-1/2		104630	CB-2228-28	5	104692	CB-2428-40					
		4	104631	CB-2228-32	5-1/2		104693	CB-2428-44								
1-1/4	1-3/4	1-1/4	105034	CB-2028-10	1-3/8	1-7/8	3	104632	CB-2230-24	1-1/2	1-13/16	3	104694	CB-2429-24		
		1-3/4	104572	CB-2028-14			3-1/2	104633	CB-2230-28	1-1/2	1-7/8	1-1/2	104695	CB-2430-12		
		2	104573	CB-2028-16			4	104634	CB-2230-32	2	104696	CB-2430-16				
		2-1/4	104574	CB-2028-18	4-1/2	104635	CB-2230-36	2-1/2	104697	CB-2430-20						
		2-1/2	104575	CB-2028-20	1-3/8	2	3	104636	CB-2232-24	2-3/4	104698	CB-2430-22				
		2-3/4	104576	CB-2028-22			4	104637	CB-2232-32	3	104699	CB-2430-24				
		3	104577	CB-2028-24	1-3/8	2-1/8	6-1/2	104638	CB-2234-52	3-1/2	104700	CB-2430-28				
		3-1/2	104578	CB-2028-28			1-7/16	1-5/8	1-3/4	104639	CB-2326-14	4	104701	CB-2430-32		
		3-3/4	104579	CB-2028-30	2-3/4	104640			CB-2326-22	4-1/2	104704	CB-2430-36				
		4	104580	CB-2028-32	3	104641			CB-2326-24	5	104705	CB-2430-40				
		5	104582	CB-2028-40	1-7/16	1-11/16	2-1/2	104642	CB-2327-20	5-1/2	104706	CB-2430-44				
		1-1/4	1-7/8	2	104583	CB-2030-16	3		104643	CB-2327-24	1-1/2	2	2	105036	CB-2432-16	
2-1/2	104584			CB-2030-20	3-1/2	104644	CB-2327-28	2-1/2	104707	CB-2432-20						
3	104585			CB-2030-24	4	104645	CB-2327-32	3	104708	CB-2432-24						
4	104586			CB-2030-32	4-1/4	104646	CB-2327-34	3-1/2	104709	CB-2432-28						
1-1/4	2	3	104587	CB-2032-24	1-7/16	1-3/4	2-1/4	104648	CB-2328-18	4			104710	CB-2432-32		
		4	104588	CB-2032-32			3	104649	CB-2328-24	4-1/2			104711	CB-2432-36		
		6-1/2	104589	CB-2032-52			4	104650	CB-2328-32	5	104712	CB-2432-40				
1-5/16	1-1/2	1-3/4	104594	CB-2124-14	1-7/16	1-13/16	3	104651	CB-2329-24	1-1/2	2-1/8	3	104713	CB-2434-24		
		3	104595	CB-2124-24			3-1/4	104652	CB-2329-26	4	104714	CB-2434-32				
1-5/16	1-9/16	3	104596	CB-2125-24			3-1/2	104653	CB-2329-28	1-1/2	2-1/4	3	104716	CB-2436-24		
		3-1/2	104597	CB-2125-28			4	104654	CB-2329-32			4	104717	CB-2436-32		
		4	104598	CB-2125-32			4-1/4	104655	CB-2329-34			5	104718	CB-2436-40		
1-5/16	1-5/8	2	104599	CB-2126-16	5	104656	CB-2329-40	6-1/2	104719	CB-2436-52						
		2-1/2	104600	CB-2126-20	1-7/16	1-7/8	3	104657	CB-2330-24	1-9/16	1-13/16	3	104723	CB-2529-24		
		3	104601	CB-2126-24			4	104658	CB-2330-32			3-1/2	104724	CB-2529-28		
		4	104602	CB-2126-32			4-1/2	104660	CB-2330-36			4	104725	CB-2529-32		
		4-3/4	104603	CB-2126-38	5	104661	CB-2330-40	1-9/16	1-15/16	3-1/2	104726	CB-2531-28				
						4-1/2	104727			CB-2531-36						
1-5/16	1-11/16	2-1/2	104604	CB-2127-20	1-7/16	1-15/16	2	104662	CB-2331-16	1-5/8	1-7/8	2-1/4	104728	CB-2630-18		
		3	104605	CB-2127-24			3	104663	CB-2331-24			3	104730	CB-2630-24		
		4	104607	CB-2127-32			3-1/2	104664	CB-2331-28			3-3/4	104731	CB-2630-30		
1-5/16	1-13/16	3	104608	CB-2129-24	1-5/16	1-7/8	4	104665	CB-2331-32	1-5/8	2	1-3/4	104736	CB-2632-14		
		4	104610	CB-2129-32			4-1/2	104667	CB-2331-36			2-1/2	104737	CB-2632-20		
1-5/16	1-7/8	3-1/2	104611	CB-2130-28			5	104668	CB-2331-40			3	104738	CB-2632-24		
		4-1/2	104612	CB-2130-36			5-1/2	104669	CB-2331-44			3-1/2	104739	CB-2632-28		
1-3/8	1-1/2	1-3/4	104613	CB-2224-14			1-7/16	2	4			104672	CB-2332-32	1-1/2	1-5/8	4
		2	104615	CB-2224-16	1-1/2	1-11/16			2-3/4	104679	CB-2427-22	4-1/2	104741			CB-2632-36
		2-1/2	104616	CB-2224-20	1-1/2	1-3/4	1	104680	CB-2428-08	5	104742	CB-2632-40				
1-3/8	1-5/8	1-1/4	104617	CB-2226-10			1-1/4	104681	CB-2428-10	5-1/2	104743	CB-2632-44				
		1-1/2	105035	CB-2226-12												
		2	104618	CB-2226-16												
		3	104619	CB-2226-24												

*Other sizes, tolerances, lubricants and materials are available on special orders.



I.D.	O.D.	LENGTH	ITEM NO.	PART NO.		
1-5/8	2-1/8	3	104744	CB-2634-24		
		4	104745	CB-2634-32		
		4-1/2	104746	CB-2634-36		
		5	104747	CB-2634-40		
1-11/16	1-15/16	3	104748	CB-2731-24		
		3-1/2	104749	CB-2731-28		
1-11/16	2	3-1/2	104750	CB-2732-28		
		4-1/2	104751	CB-2732-36		
1-11/16	2-1/16	3	104752	CB-2733-24		
		3-1/2	104753	CB-2733-28		
		4	104754	CB-2733-32		
		4-1/2	104755	CB-2733-36		
		5	104756	CB-2733-40		
1-11/16	2-3/16	2	104757	CB-2733-44		
		2-1/2	104758	CB-2735-16		
		3	104759	CB-2735-20		
		3-1/2	104760	CB-2735-24		
		4	104761	CB-2735-28		
1-11/16	2-1/4	4	104762	CB-2735-32		
		4-1/2	104763	CB-2735-36		
		5-1/2	104764	CB-2735-40		
		3	104765	CB-2736-24		
		4-1/2	104766	CB-2736-36		
1-3/4	2	1-1/2	104772	CB-2832-12		
		2	104773	CB-2832-16		
		2-1/4	104774	CB-2832-18		
		2-1/2	104775	CB-2832-20		
		3	104776	CB-2832-24		
		4	104777	CB-2832-32		
		4-1/2	104778	CB-2832-36		
		5-1/4	104779	CB-2832-42		
		3-1/2	104780	CB-2833-28		
		1-3/4	2-1/8	2-1/2	105037	CB-2834-20
2-3/4	104781			CB-2834-22		
3-1/4	104782			CB-2834-26		
3-1/2	104783			CB-2834-28		
4	104784			CB-2834-32		
4-1/4	104785			CB-2834-34		
5	104786			CB-2834-40		
5-1/2	104787			CB-2834-44		
1-3/4	2-1/4			1-3/4	104788	CB-2836-14
				2	104789	CB-2836-16
		2-1/2	104790	CB-2836-20		
		3	104791	CB-2836-24		
		3-1/2	104792	CB-2836-28		
		4	104793	CB-2836-32		
		4-1/4	104794	CB-2836-34		
		5	104796	CB-2836-40		
		1-3/4	2-3/8	3-1/2	104797	CB-2838-28
				4-1/2	104798	CB-2838-36
5	104799			CB-2838-40		

I.D.	O.D.	LENGTH	ITEM NO.	PART NO.
1-3/4	2-1/2	6-1/2	104801	CB-2840-52
1-13/16	2-3/16	4	104802	CB-2935-32
		5-1/4	104803	CB-2935-42
1-13/16	2-5/16	4	104804	CB-2937-32
		5	104805	CB-2937-40
1-7/8	2-1/8	2-1/2	104806	CB-3034-20
		3	104807	CB-3034-24
		4	104808	CB-3034-32
1-7/8	2-1/4	3	104809	CB-3036-24
		3-1/4	104810	CB-3036-26
		4	104812	CB-3036-32
		5	104815	CB-3036-40
1-7/8	2-3/8	3	104816	CB-3038-24
		4	104817	CB-3038-32
		5-1/4	104818	CB-3038-42
1-15/16	2-3/16	2	104820	CB-3135-16
		3	104821	CB-3135-24
		4	104822	CB-3135-32
		3	104823	CB-3136-24
1-15/16	2-1/4	4-1/2	104824	CB-3136-36
		3-1/2	104825	CB-3137-28
1-15/16	2-5/16	4	104826	CB-3137-32
		5	104827	CB-3137-40
		5-1/2	104828	CB-3137-44
1-15/16	2-3/8	6-1/4	104829	CB-3137-50
		3	104830	CB-3138-24
		4	104831	CB-3138-32
1-15/16	2-7/16	5-1/2	104832	CB-3138-44
		3	104833	CB-3139-24
		4	104834	CB-3139-32
1-15/16	2-1/2	5	104835	CB-3139-40
		5-1/2	104836	CB-3139-44
		3	104837	CB-3140-24
		5	104838	CB-3140-40
2	2-1/4	2	104839	CB-3236-16
		2-1/2	104840	CB-3236-20
		3	104841	CB-3236-24
		3-1/2	104842	CB-3236-28
		3-3/4	104843	CB-3236-30
		4	104844	CB-3236-32
		4-1/2	104845	CB-3236-36
		5	104846	CB-3236-40
		2	304839	M3236-16
		2	2-3/8	2-1/2
3	104848			CB-3238-24
3-1/2	104849			CB-3238-28
4	104850			CB-3238-32
4-1/2	104851			CB-3238-36
2	2-1/2	2	105044	CB-3240-16
		2-1/2	104853	CB-3240-20
		3	104854	CB-3240-24

I.D.	O.D.	LENGTH	ITEM NO.	PART NO.
2	2-1/2	3-1/2	104855	CB-3240-28
		4	104856	CB-3240-32
		4-1/2	104857	CB-3240-36
		5	104858	CB-3240-40
		5-1/2	104859	CB-3240-44
		6	104860	CB-3240-48
2	2-5/8	4	104861	CB-3242-32
2	2-3/4	6	105038	CB-3244-48
		6-1/2	104864	CB-3244-52
2-1/8	2-1/2	3	104865	CB-3440-24
		4	104866	CB-3440-32
2-1/8	2-5/8	4	104867	CB-3442-32
		5	104868	CB-3442-40
		6	104869	CB-3442-48
2-3/16	2-5/8	4	104870	CB-3542-32
		5	104871	CB-3542-40
2-3/16	2-11/16	3-1/2	104872	CB-3543-28
		4	104873	CB-3543-32
		4-1/2	104874	CB-3543-36
2-3/16	2-3/4	5	104875	CB-3543-40
		4-1/2	104876	CB-3544-36
		5-1/4	104877	CB-3544-42
2-3/16	2-7/8	6	104878	CB-3544-48
		4-1/2	104879	CB-3546-36
		3	105039	CB-3640-24
2-1/4	2-1/2	3-1/2	104880	CB-3640-28
		4	104881	CB-3640-32
		3	104882	CB-3642-24
2-1/4	2-5/8	4	104883	CB-3642-32
		5	104884	CB-3642-40
		4-3/4	104886	CB-3643-38
2-1/4	2-3/4	3	105040	CB-3644-24
		3-1/2	104887	CB-3644-28
2-1/4	3	4	104888	CB-3644-32
		4-1/2	104889	CB-3644-36
		5	104890	CB-3644-40
		6	104891	CB-3644-48
		6-1/2	104892	CB-3644-52
		3-1/2	104893	CB-3648-28
2-1/4	3	5	104894	CB-3648-40
		6-1/2	104895	CB-3650-52
		4	104896	CB-3844-32
2-3/8	2-3/4	5	104897	CB-3844-40
		6	104898	CB-3844-48
		4	104899	CB-3846-32
2-3/8	2-7/8	5	104900	CB-3846-40
		6	104901	CB-3846-48
		4	104902	CB-3944-32
2-7/16	2-3/4	5	104903	CB-3944-40
		3	104905	CB-3946-24
2-7/16	2-7/8	5	104906	CB-3946-40
		4	104907	CB-3947-32
2-7/16	2-15/16	5	104908	CB-3947-40
		6-1/4	104909	CB-3947-50
		3-3/4	104911	CB-3948-30
2-7/16	3	5	104912	CB-3948-40
		6-1/4	104913	CB-3948-50
		3	104914	CB-4044-24
2-1/2	2-3/4	4	104915	CB-4044-32
		5	104917	CB-4044-40
2-1/2	2-7/8	3-1/4	104919	CB-4046-26
		4-1/2	104921	CB-4046-36

*Other sizes, tolerances, lubricants and materials are available on special orders.



I.D.	O.D.	LENGTH	ITEM NO.	PART NO.
2-1/2	3	3	104923	CB-4048-24
		3-3/4	104924	CB-4048-30
		4	104925	CB-4048-32
		5	104926	CB-4048-40
		6	104927	CB-4048-48
		7	104928	CB-4048-56
2-1/2	3-1/8	3-1/2	104929	CB-4050-28
		4	104930	CB-4050-32
		4-1/2	104931	CB-4050-36
		6-3/4	104932	CB-4050-54
2-1/2	3-1/4	4	104933	CB-4052-32
		5	104934	CB-4052-40
		6	104935	CB-4052-48
		7-1/4	104936	CB-4052-58
2-1/2	3-1/2	6-1/2	104937	CB-4056-52
2-5/8	3	3	104939	CB-4248-24
		4	104941	CB-4248-32
		5	104942	CB-4248-40
2-5/8	3-1/8	5	104943	CB-4250-40
		6	104944	CB-4250-48
		7-1/4	104945	CB-4250-58
		7	104946	CB-4252-56
2-5/8	3-1/4	7	104946	CB-4252-56
2-5/8	3-3/8	6-1/2	104947	CB-4254-52
2-11/16	3-3/16	4	104948	CB-4351-32
		5	104949	CB-4351-40
		6-1/4	104950	CB-4351-50
2-3/4	3-1/8	4	104951	CB-4450-32
		5	104952	CB-4450-40
		6	104953	CB-4450-48
2-3/4	3-1/4	4	104954	CB-4452-32
		5	104955	CB-4452-40
		6	104956	CB-4452-48
		7	104957	CB-4452-56
2-3/4	3-3/8	4	104958	CB-4454-32
		6-1/2	104959	CB-4454-52
2-3/4	3-1/2	6-1/2	104960	CB-4456-52
		4	104961	CB-4654-32
2-7/8	3-3/8	6	104962	CB-4654-48
		8	104963	CB-4654-64
		4-1/2	104964	CB-4656-36
2-7/8	3-1/2	6-3/4	104965	CB-4656-54
		3-1/2	104967	CB-4755-28
2-15/16	3-7/16	5	104968	CB-4755-40
		6-1/2	104969	CB-4755-52

I.D.	O.D.	LENGTH	ITEM NO.	PART NO.
3	3-3/8	4-1/2	104973	CB-4854-36
		8	104974	CB-4854-64
3	3-1/2	3	104975	CB-4856-24
		4	104976	CB-4856-32
		4-1/2	104977	CB-4856-36
		5-1/2	105042	CB-4856-44
		6	104978	CB-4856-48
		9	104979	CB-4856-72
3	3-5/8	5	104980	CB-4858-40
		6-1/2	104981	CB-4858-52
		8	104982	CB-4858-64
3	3-3/4	6-1/4	104983	CB-4860-50
3	4	6-1/2	104984	CB-4864-52
3-1/4	3-1/2	4	104985	CB-5256-32
3-1/4	3-3/4	5	104986	CB-5260-40
		6	104987	CB-5260-48
		9	104988	CB-5260-72
3-7/16	3-15/16	4-1/2	104989	CB-5563-36
		6-1/2	104990	CB-5563-52
3-1/2	4	4	104992	CB-5664-32
		5-1/2	104993	CB-5664-44
		6	105043	CB-5664-48
		7	104994	CB-5664-56
3-1/2	4-1/8	6	104995	CB-5666-48
3-1/2	4-1/4	4-1/2	104997	CB-5668-36
		7	104998	CB-5668-56
		9-3/4	104999	CB-5668-78
3-3/4	4-1/4	5	105000	CB-6068-40
		7	105001	CB-6068-56
3-3/4	4-1/2	6-1/2	105002	CB-6072-52
		4	105003	CB-6472-32
		6	105004	CB-6472-48
4	4-1/2	7	105005	CB-6472-56
		5	105006	CB-6476-40
		6	105007	CB-6476-48
4	4-3/4	7	105008	CB-6476-56
		5	105009	CB-6480-40
		6	105010	CB-6480-48
4-1/4	4-3/4	7	105011	CB-6480-56
		5	105012	CB-6876-40
		6	105013	CB-6876-48
4-1/4	5	7	105014	CB-6876-56
		5	105015	CB-6880-40
		6	105016	CB-6880-48
4-1/4	5	7	105017	CB-6880-56
		6	105019	CB-7280-48
		7	105020	CB-7280-56
4-1/2	5-1/2	8	105021	CB-7280-64
		6	105022	CB-7288-48
		7	105023	CB-7288-56
4-1/2	5-1/2	8	105024	CB-7288-64

I.D.	O.D.	LENGTH	ITEM NO.	PART NO.
5	5-1/2	6	105025	CB-8088-48
		7	105026	CB-8088-56
		8	105027	CB-8088-64
5	6	7	105028	CB-8096-56
		8	105029	CB-8096-64
		9	105030	CB-8096-72



I.D.	O.D.	ITEM NO.	PART NO.	AVG. WGT.
SOLID	3/8	106500	BS0003-13	.56
	1/2	106501	BS0004-13	1
	5/8	106502	BS0005-13	1.5
	3/4	106503	BS0006-13	2.1
	7/8	106504	BS0007-13	2.8
	1	106505	BS0008-13	3.7
	1-1/8	106506	BS0009-13	4.6
	1-1/4	106507	BS0010-13	5.6
	1-3/8	106508	BS0011-13	6.8
	1-1/2	106509	BS0012-13	8.0
	1-5/8	106510	BS0013-13	9.4
	1-3/4	106511	BS0014-13	10.8
	1-7/8	106512	BS0015-13	12.4
	2	106513	BS0016-13	14.0
	2-1/8	106514	BS0017-13	16.0
	2-1/4	106515	BS0018-13	17.8
	2-3/8	106516	BS0019-13	19.8
	2-1/2	106517	BS0020-13	21.9
	2-5/8	106518	BS0021-13	24.1
	2-3/4	106519	BS0022-13	26.4
	3	106521	BS0024-13	31.4
	3-1/4	106522	BS0026-13	36.7
	3-1/2	106523	BS0028-13	42.5
	3-3/4	106524	BS0030-13	48.8
	4	106525	BS0032-13	56.4
	4-1/4	106526	BS0034-13	63.5
	4-1/2	106527	BS0036-13	71.1
	4-3/4	106528	BS0038-13	79.1
	5	106529	BS0040-13	88.6
	5-1/2	106530	BS0044-13	107.0
6	106531	BS0048-13	126.9	
6-1/2	106532	BS0052-13	148.0	
7	106533	BS0056-13	171.9	
7-1/2	106534	BS0060-13	196.9	
8	106535	BS0064-13	223.6	
9	106537	BS0072-13	282.2	
1/2	1	106001	BC0408-13	3.0
	1-1/8	106002	BC0409-13	3.9
	1-1/4	106003	BC0410-13	4.9
	1-1/2	106005	BC0412-13	7.3
	1-3/4	106006	BC0414-13	10.2
	2	106007	BC0416-13	13.4
5/8	1	106008	BC0508-13	2.5
	1-1/8	106009	BC0509-13	3.5
	1-1/4	106010	BC0510-13	4.5
	1-3/8	106011	BC0511-13	5.6
	2	106015	BC0516-13	13.6
3/4	1	106017	BC0608-13	2.0
	1-1/8	106018	BC0609-13	2.9
	1-1/4	106019	BC0610-13	4.0
	1-3/8	106020	BC0611-13	5.1
	1-1/2	106021	BC0612-13	6.4
	1-3/4	106023	BC0614-13	9.2
	2	106025	BC0616-13	12.4
	2-1/4	106027	BC0618-13	16.1
	2-1/2	106028	BC0620-13	20.2
	2-3/4	106029	BC0622-13	24.7

I.D.	O.D.	ITEM NO.	PART NO.	AVG. WGT.
7/8	1-1/8	106030	BC0709-13	2.3
	1-1/4	106031	BC0710-13	3.3
	1-3/8	106032	BC0711-13	4.5
	1-1/2	106033	BC0712-13	5.7
	1-5/8	106034	BC0713-13	7.1
	1-3/4	106035	BC0714-13	8.5
	2	106037	BC0716-13	11.8
1	1-1/4	106040	BC0810-13	2.6
	1-3/8	106041	BC0811-13	3.7
	1-1/2	106042	BC0812-13	5.0
	1-5/8	106043	BC0813-13	6.3
	1-3/4	106044	BC0814-13	7.8
	2	106046	BC0816-13	11.0
	2-1/4	106048	BC0818-13	14.7
	2-3/8	106049	BC0819-13	16.7
	2-1/2	106050	BC0820-13	18.8
	2-3/4	106051	BC0822-13	23.3
	3	106052	BC0824-13	28.3
	3-1/4	106053	BC0826-13	33.7
	3-1/2	106054	BC0828-13	39.5
	4	106055	BC0832-13	53.3
	2	306046	MCB1632	11.0
1-1/8	1-5/8	106058	BC0913-13	5.4
	1-7/8	106060	BC0915-13	8.5
	2	106061	BC0916-13	10.2
1-1/4	1-1/2	106068	BC1012-13	3.0
	1-5/8	106069	BC1013-13	4.4
	1-3/4	106070	BC1014-13	5.9
	1-7/8	106071	BC1015-13	7.5
	2	106072	BC1016-13	9.2
	2-1/4	106074	BC1018-13	12.9
	2-1/2	106076	BC1020-13	17.0
	2-3/4	106078	BC1022-13	21.5
	3	106080	BC1024-13	26.4
	3-1/4	106081	BC1026-13	31.8
	3-1/2	106082	BC1028-13	37.6
	4	106083	BC1032-13	51.8
1-3/8	1-3/4	106085	BC1114-13	4.9
	2	106087	BC1116-13	8.1
	2-1/8	106088	BC1117-13	9.9
	2-1/2	106091	BC1120-13	15.9
	3	106094	BC1124-13	25.4
1-1/2	1-3/4	106095	BC1214-13	3.7
	2	106097	BC1216-13	6.9
	2-1/8	106098	BC1217-13	8.7
	2-1/4	106099	BC1218-13	10.6
	2-3/8	106100	BC1219-13	12.6
	2-1/2	106101	BC1220-13	14.7
	2-3/4	106103	BC1222-13	19.2
	3	106104	BC1224-13	24.2
	3-1/4	106105	BC1226-13	29.6
	3-1/2	106106	BC1228-13	35.4
	3-3/4	106107	BC1230-13	41.6
	4	106108	BC1232-13	49.6
	4-1/2	106109	BC1236-13	64.3

I.D.	O.D.	ITEM NO.	PART NO.	AVG. WGT.
1-5/8	2	106110	BC1316-13	5.6
	2-1/8	106111	BC1317-13	7.4
	2-1/4	106112	BC1318-13	9.3
	3	106117	BC1324-13	22.9
1-3/4	2	106118	BC1416-13	4.3
	2-1/4	106120	BC1418-13	7.9
	2-3/8	106121	BC1419-13	9.9
	2-1/2	106122	BC1420-13	12.0
	2-5/8	106123	BC1421-13	14.2
	2-3/4	106124	BC1422-13	16.6
	3	106126	BC1424-13	21.5
	3-1/4	106127	BC1426-13	26.9
	3-1/2	106128	BC1428-13	32.7
	3-3/4	106129	BC1430-13	38.9
	4	106130	BC1432-13	47.0
	2-3/8	106133	BC1519-13	8.4
1-7/8	2-5/8	106135	BC1521-13	12.7
2	2-1/4	106140	BC1618-13	4.8
	2-1/2	106141	BC1620-13	8.9
	2-5/8	106142	BC1621-13	11.1
	2-3/4	106143	BC1622-13	13.4
	2-7/8	106144	BC1623-13	15.9
	3	106145	BC1624-13	18.4
	3-1/4	106146	BC1626-13	23.8
	3-1/2	106147	BC1628-13	29.6
	3-3/4	106148	BC1630-13	35.8
	4	106149	BC1632-13	43.9
	4-1/2	106150	BC1636-13	58.6
	5	106151	BC1640-13	76.5
	5-1/2	106152	BC1644-13	95.6
	6	106153	BC1648-13	115.0
2-1/8	2-5/8	106154	BC1721-13	9.4
	2-3/4	106155	BC1722-13	11.7
	2-7/8	106156	BC1723-13	14.2
2-1/4	2-3/4	106161	BC1822-13	9.9
	2-7/8	106162	BC1823-13	12.3
	3	106163	BC1824-13	14.8
	3-1/4	106165	BC1826-13	20.2
	3-1/2	106166	BC1828-13	26
	3-3/4	106167	BC1830-13	32.2
	4	106168	BC1832-13	40.5
	4-1/4	106169	BC1834-13	47.5
2-3/8	2-7/8	106170	BC1923-13	10.3
	3	106171	BC1924-13	12.8
	3-1/4	106172	BC1926-13	18.2
	3-1/2	106173	BC1928-13	24.1
2-1/2	3	106176	BC2024-13	10.8
	3-1/4	106178	BC2026-13	16.2
	3-1/2	106179	BC2028-13	22.1
	3-3/4	106180	BC2030-13	28.2
	4	106181	BC2032-13	36.5
	4-1/4	106182	BC2034-13	43.7
	4-1/2	106183	BC2036-13	51.2

*Other sizes, tolerances, lubricants and materials are available on special orders.



I.D.	O.D.	ITEM NO.	PART NO.	AVG. WGT.
2-1/2	4-3/4	106184	BC2038-13	59.2
	5	106185	BC2040-13	69.1
	5-1/2	106186	BC2044-13	87.8
	6	106187	BC2048-13	107.6
2-5/8	3-1/2	106188	BC2128-13	19.8
2-3/4	3-1/4	106192	BC2226-13	12.6
	3-1/2	106193	BC2228-13	17.7
	3-3/4	106194	BC2230-13	23.8
	4	106195	BC2232-13	32.2
	4-1/4	106196	BC2234-13	39.4
	4-1/2	106197	BC2236-13	47
4-3/4	106198	BC2238-13	54.9	
2-7/8	4	106199	BC2332-13	29.8
3	3-1/2	106200	BC2428-13	12.8
	3-3/4	106201	BC2430-13	19.1
	4	106202	BC2432-13	27.5
	4-1/4	106203	BC2434-13	34.7
	4-1/2	106204	BC2436-13	42.2
	4-3/4	106205	BC2438-13	50.2
	5	106206	BC2440-13	60.2
	5-1/2	106207	BC2444-13	78.9
	6	106208	BC2448-13	98.8
	6-1/2	106209	BC2452-13	120.4
3-1/4	4	106210	BC2632-13	22.2
	4-1/4	106211	BC2634-13	29.5
	4-1/2	106212	BC2636-13	37
	4-3/4	106213	BC2638-13	45
	5	106214	BC2640-13	55.2
3-1/2	4	106216	BC2832-13	16.7
	4-1/4	106217	BC2834-13	23.8
	4-1/2	106218	BC2836-13	31.5
	4-3/4	106219	BC2838-13	39.4
	5	106220	BC2840-13	49.5
	5-1/2	106221	BC2844-13	68.3
	6	106222	BC2848-13	88.1
6-1/2	106223	BC2852-13	109.8	
3-3/4	4-1/2	106224	BC3036-13	25.3
	4-3/4	106225	BC3038-13	33.4
	5	106226	BC3040-13	43.7
	5-1/2	106228	BC3044-13	62.2
	6	106229	BC3048-13	82.1

Special Products Available

- Larger diameter 13" bars
- Longer length bars up to 105"
- Special bearings machined per print

I.D.	O.D.	ITEM NO.	PART NO.	AVG. WGT.
4	4-1/2	106230	BC3236-13	19
	4-3/4	106231	BC3238-13	27
	5	106232	BC3240-13	37.2
	5-1/4	106233	BC3242-13	46.5
	5-1/2	106234	BC3244-13	55.9
	6	106235	BC3248-13	75.9
	6-1/2	106236	BC3252-13	97.5
	7	106237	BC3256-13	120.8
4-1/4	5-1/4	106241	BC3442-13	38.4
	5-1/2	106242	BC3444-13	49.0
	6	106243	BC3448-13	69.0
	6-1/2	106244	BC3452-13	90.6
4-1/2	5	106245	BC3640-13	23.2
	5-1/2	106246	BC3644-13	41.9
	6	106247	BC3648-13	61.7
	6-1/2	106248	BC3652-13	83.4
	7	106249	BC3656-13	106.8
4-3/4	5-3/4	106250	BC3846-13	43.5
	6	106251	BC3848-13	54.2
	6-1/2	106252	BC3852-13	75.8
5	6	106255	BC4048-13	46.0
	6-1/2	106256	BC4052-13	67.6
	7	106257	BC4056-13	91

I.D.	O.D.	ITEM NO.	PART NO.	AVG. WGT.
5	7-1/2	106258	BC4060-13	116.0
	8	106259	BC4064-13	142.8
	9	106260	BC4072-13	201.3
5-1/4	7	106262	BC4256-13	82.5
5-1/2	6-1/2	106264	BC4452-13	50.2
	7	106265	BC4456-13	73.5
	7-1/2	106266	BC4460-13	98.5
	8	106267	BC4464-13	125.4
5-3/4	6-3/4	106268	BC4654-13	51.7
	7-1/2	106269	BC4660-13	89.3
6	6-3/4	106272	BC4854-13	41.4
	7	106273	BC4856-13	54.5
	7-1/2	106274	BC4860-13	79.5
	8	106275	BC4864-13	106.1
	8-1/2	106276	BC4868-13	134.6
6-1/2	7-1/2	106279	BC5260-13	58.7
	8	106280	BC5264-13	85.4
	9	106281	BC5272-13	144
7	8	106284	BC5664-13	62.9
	9	106285	BC5672-13	121.4
	10	106292	BC6480-13	131.8
8	9	106291	BC6472-13	71.3
	10	106292	BC6480-13	131.8
9	10	106295	BC7280-13	78.8

Finish Allowances

Actual sizes provided approximate allowances for finish as follows:

Outside Diameter

0 - 4"
4 - 5"
5 - 9"

Finish I.D. & O.D.

1/32" .03125"
1/16" .06250"
3/32" .09375"

Maximum Values (PV = P x V)

MATERIAL	PV	P-LOAD	V-SFM	Temperature Range
POWDERED METAL				
1. Iron (SAE 850)	30,000	3,000	400	-----
2. Bronze (SAE 841)	50,000	2,000	1,200	220° F
3. Iron - Copper (SAE 863)	35,000	4,000	225	10° to 220° F
4. Heat Treated Iron Copper	75,000	8,000	35	-----
CAST BRONZE				
1. Manganese Bronze (C863)	150,000	8,000	100	-450° to + 400° F
2. Aluminum Bronze (C954)	125,000	4,000	225	-450° to + 750° F
3. Bronze (SAE 660 / C932)	75,000	3,000	750	-450° to + 450° F
STEEL BACKED				
1. TU Self-Lubricating	102,000	36,250	2,000	-328° to + 536° F
2. TP Self-Lube - Lead Free	102,000	36,250	2,000	-328° to + 536° F

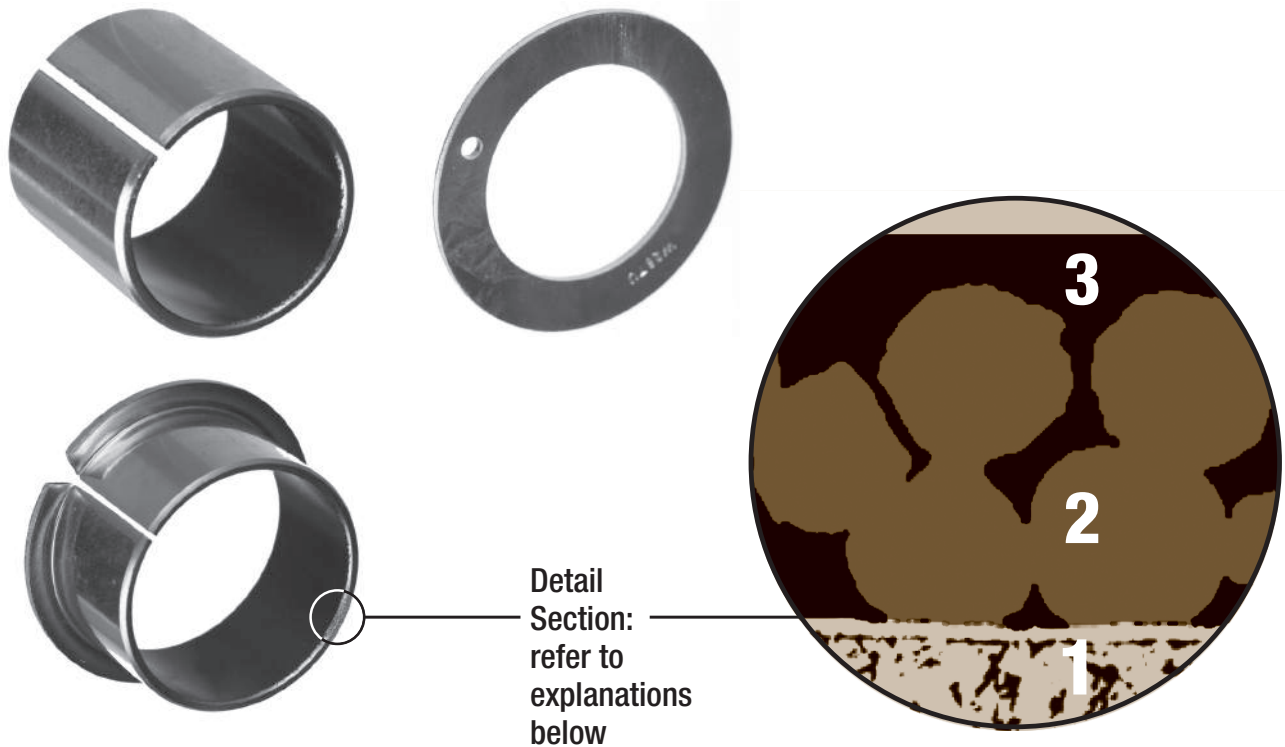

Detail Section: refer to explanations below

TU™ and TP™ are composites of the following materials which are used to produce self-lubricating dry sliding bearings

TU™ - STEEL-BACKED PTFE LINED

STRUCTURE

1. Low carbon **STEEL** backing allows for extremely high load capacity (0.50 - 2.7 mm thickness)
2. Sintered **BRONZE** offers optimal heat dispersion (0.20 - 3.5 mm thickness)
3. **PTFE** with lead sliding surface creates a low friction coefficient and allows for a wide temperature range (0.20 mm thickness)

FEATURES

Self-lubricating, dry running for use where many oiled bearings fail. Low coefficient of friction, low wear, forms an oxide type solid lubricant film, suitable for linear, rotary and oscillating applications. High chemical resistance and low moisture absorption and swelling. Performance increases with lubrication. REACH, DFARS compliant.

TP™ - LEAD-FREE STEEL-BACKED PTFE LINED

STRUCTURE

1. Low carbon **STEEL** backing allows for extremely high load capacity (0.50 - 2.7 mm thickness)
2. Sintered **BRONZE** offers optimal heat dispersion (0.20 - 3.5 mm thickness)
3. **PTFE** with lead-free fibers creates a low friction coefficient and allows for a wide temperature range (0.02 mm thickness)

FEATURES

Lead-Free, self lubricating, dry running for use where many oiled bearing fail. Low coefficient of friction, low wear, forms an oxide type solid lubricant film, suitable for linear, rotary and oscillating applications. High chemical resistance and low moisture absorption and swelling. Performance increases with lubrication. RoHS, REACH, EVL, WEEE & DFARS compliant.

DESIGN PARAMETERS

LOADS - P Dynamic pressures up to 20,300 psi (140 N/mm²); static loads up to 36,250 psi (250 N/mm²)

SPEEDS-V Speeds up to 2,000 sfpm (10 m/s) with lubrication

PERFORMANCE - PV PV's up to 51,000 psi-sfpm (1.8 N/mm² x m/s) for continuous loads, 102,000 psi-sfpm (3.6 N/mm² x m/s) for short-term use and 26,000 psi-sfpm (.9 N/mm² x m/s) for alternating loads. Performance increases when lubricated.

TEMPERATURES From -328 to +536° F (-200 to + 280° C).

CALCULATION of the SERVICE LIFE ($L_h = \text{hours}$)

Description	Symbol	Units of Measure
Internal diameter of the bearing	D_1	mm
Internal diameter of the thrust washer	D_4	mm
External diameter of the thrust washer	D_5	mm
Length of the bearing	B	mm
Load on the bearing	L	N=(Newton)
Speed of rotation	N	r.p.m.
Angle of oscillation	φ	° degrees
Frequency of oscillation	N_{osz}	cycles/minutes
Nominal life	L_h	hours
External radius of the thrust washer	R	mm
Internal radius of the thrust washer	r	mm

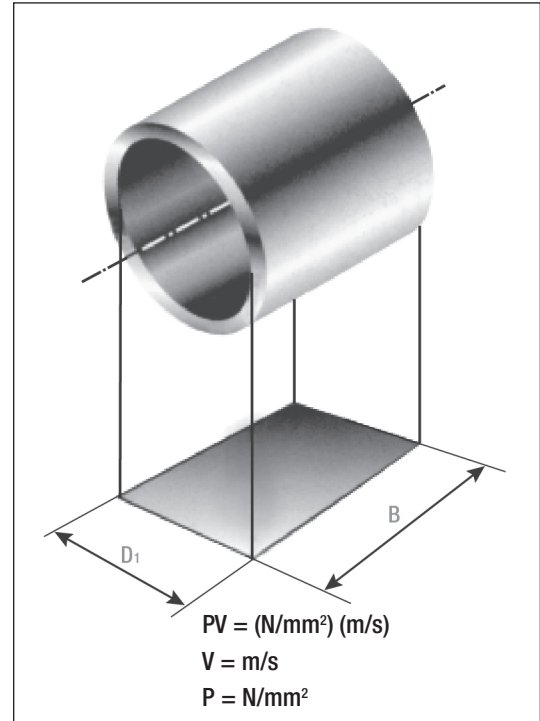

Metric Conversion Chart		
	Multiply by	
Inch [in]	25.4	Millimeters [mm]
Pounds/force [lbf]	4.4482	Newton [n]
foot/minute [ft/min]	0.00508	Meter / second [m/s]
Pounds per square inch [psi]	0.006895	Newton / square millimeter [N/mm²]

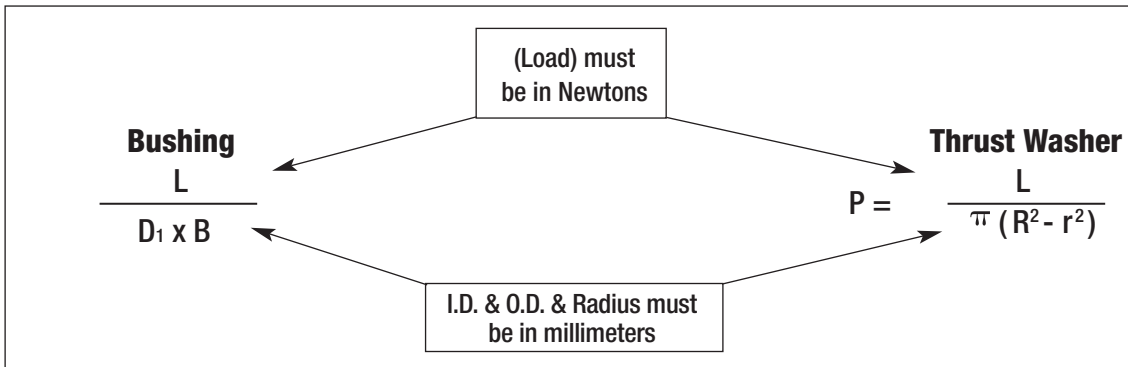

Due to the many different factors involved, the Life formula should only be treated as a rough estimate.

ROTATION of BEARING $V = \frac{\pi \times D_1 \times N}{60 \times 10^3}$	OSCILLATION of BEARING $V = \frac{\pi \times D_1 \times 2\varphi \times N_{osz}}{60 \times 10^3 \times 360}$
ROTATION of WASHER $V = \frac{\pi \times D_5 \times N}{60 \times 10^3}$	OSCILLATION of WASHER $V = \frac{\pi \times D_5}{60 \times 10^3} \times \frac{2\varphi \times N_{osz}}{360}$

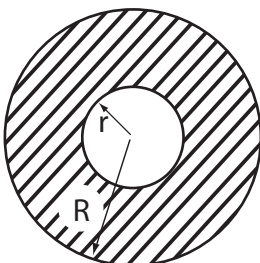

Thrust Washer

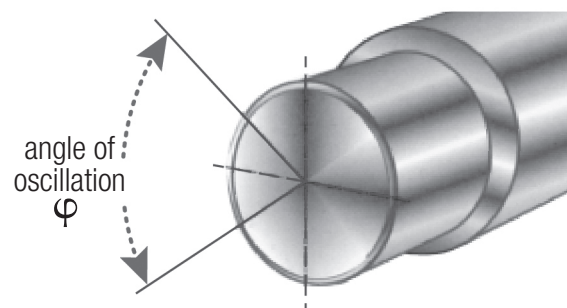

CALCULATION of the SERVICE LIFE ($L_h = \text{hours}$)

The operating life for dry applications of TU™ Self-lubricating bearings is inversely proportional to the load factor ($p \times v$) but, in order to achieve a close approximation of the figure, the following corrective factors must be introduced:

- K_a = constant relative to the type of application;
- f_p = load correction factor;
- f_c = application characteristics and temperature
- f_d = correction factor;
- f_m = bearing size correction factor;
shaft material correction factor.

$$L_h = \frac{K_a}{pv^{1.2}} \times f_p \times f_c \times f_d \times f_m$$

f_p = load correction factor				
$p = \text{N/mm}^2 \text{ or psi}$				
N/mm ²	<10	<25	<50	> 60
psi	<1450	<3625	<7252	<8702
	1	0.3	0.2	0.1

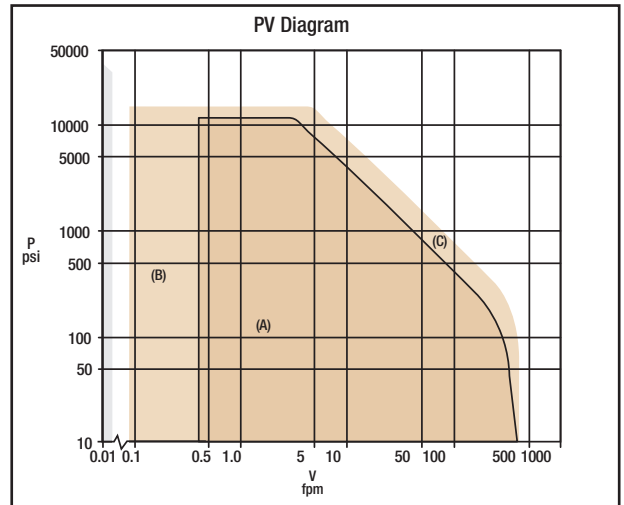

- A. Service life calculation may be used.
- B. Quasi-static: Call before using this Calculation
- C. Requires optimal heat removal.

f_c = application characteristics and temperature correction factor							
Characteristics	Heat Dissipation	Temperature °C					
		20	60	100	150	200	280
Continuous Dry Operation	Good	1.0	0.8	0.6	0.4	0.2	0.1
Continuous Dry Operation	Poor	0.5	0.4	0.3	0.2	0.1	-
Intermittent Operation Interval > 10 x Operating Time	Good	2.0	1.6	1.2	0.8	0.4	0.2
Constant Immersion in Water		2.0	1.6	0.8	-	-	-
Alternating Immersion in Water		0.4	0.2	0.1	-	-	-
Constant Immersion in Lubricant		3.0	2.4	1.8	1.2	0.8	-

f_m = shaft material correction factor	
Material	f_m
Low carbon steel	1
Hardened steel	1.5
Stainless Steel	2
Cast iron (0.4 RQ)	1
Aluminum	0.4
Bronze	0.4
Plating	
	f_m
Zinc Cadmium	0.2
Nickel	0.2
Chrome	2
Anodized aluminum	2

K_a = constant relative to the type of application		
UNIDIRECTIONAL LOAD	ROTATING LOAD	THRUST LOAD
400	800	250

f_d = bearing size correction factor					
Shaft diameter (mm)					
(mm)	≤ 20	≤ 40	≤ 100	≤ 150	> 150
(inch)	< .8	< 1.6	< 3.9	< 5.9	> 5.9
	1.0	0.9	0.7	0.5	0.4



TU™ SLEEVE BEARINGS (Inch Sizes)

Nominal Bearing Bore	Recommended		Installed Bearing I.D.	Length ± .010"	Item Number	Part Number
	Shaft Dia.	Housing Bore				
1/8	.1243	.1878	.1268	1/8	501001	02TU02
	.1236	.1873	.1243	3/16	501002	02TU03
5/32	.1554	.2191	.1581	5/32	501003	025TU025
	.1547	.2186	.1556	1/4	501004	025TU04
3/16	.1865 .1858	.2503 .2497	.1893	3/16	501005	03TU03
			.1867	1/4	501006	03TU04
				3/8	501007	03TU06
1/4	.2490 .2481	.3128 .3122	.2518	1/4	501008	04TU04
			.2492	3/8	501009	04TU06
5/16	.3115 .3106	.3753 .3747	.3143	3/8	501010	05TU06
			.3117	1/2	501011	05TU08
3/8	.3740 .3731	.4691 .4684	.3769	3/16	501012	06TU03
			.3742	1/4	501013	06TU04
				3/8	501014	06TU06
				1/2	501015	06TU08
				5/8	501016	06TU10
			3/4	501017	06TU12	
7/16	.4365 .4355	.5316 .5309	.4394	1/2	501018	07TU08
			.4367	3/4	501019	07TU12
1/2	.4990 .4980	.5941 .5934	.5019	1/4	501020	08TU04
			.4992	3/8	501021	08TU06
				1/2	501022	08TU08
				5/8	501023	08TU10
				3/4	501024	08TU12
			7/8	501025	08TU14	
9/16	.5615 .5605	.6566 .6559	.5644	3/8	501026	09TU06
			.5617	1/2	501027	09TU08
				5/8	501028	09TU10
				3/4	501029	09TU12
5/8	.6240 .6230	.7192 .7184	.6270	1/4	501030	10TU04
			.6242	1/2	501031	10TU08
				5/8	501032	10TU10
				3/4	501033	10TU12
				7/8	501034	10TU14
			1	501035	10TU16	
11/16	.6865 .6855	.7817 .7809	.6895	7/8	501036	11TU14
			.6867			
3/4	.7491 .7479	.8755 .8747	.7525	1/4	501037	12TU04
			.7493	3/8	501038	12TU06
				1/2	501039	12TU08
				5/8	501040	12TU10
				3/4	501041	12TU12
			1	501042	12TU16	
13/16	.8116 .8104	.9380 .9372	.8150	3/4	501043	13TU12
			.8118	1-1/8	501044	13TU18
7/8	.8741 .8729	1.0005 .9997	.8775	1/4	501045	14TU04
			.8743	3/8	501046	14TU06
				3/4	501047	14TU12
				7/8	501048	14TU14
				1	501049	14TU16
				1-1/4	501050	14TU20
1	.9991 .9979	1.1255 1.1247	1.0025	3/8	501051	16TU06
			.9993	1/2	501052	16TU08
				3/4	501053	16TU12
				1	501054	16TU16
				1-1/4	501055	16TU20
				1-1/2	501056	16TU24
1-1/8	1.1238 1.1266	1.2818 1.2808	1.1278	3/8	501057	18TU06
			1.1240	5/8	501058	18TU10
				3/4	501059	18TU12
				1	501060	18TU16
1-1/4	1.2488 1.2472	1.4068 1.4058	1.2528	3/8	501061	20TU06
			1.2490	3/4	501062	20TU12
				7/8	501063	20TU14
				1	501064	20TU16
				1-1/4	501065	20TU20
			1-3/4	501066	20TU28	

Nominal Bearing Bore	Recommended		Installed Bearing I.D.	Length ± .010"	Item Number	Part Number
	Shaft Dia.	Housing Bore				
1-3/8	1.3738 1.3722	1.5318 1.5308	1.3778	3/4	501067	22TU12
			1.3740	1	501068	22TU16
				1-3/8	501069	22TU22
				1-1/2	501070	22TU24
			1-3/4	501071	22TU28	
1-1/2	1.4988 1.4972	1.6568 1.6558	1.5028	1/2	501072	24TU08
			1.4990	1	501073	24TU16
				1-1/8	501074	24TU18
				1-1/4	501075	24TU20
				1-1/2	501076	24TU24
			2	501077	24TU32	
1-5/8	1.6238 1.6222	1.7818 1.7808	1.6278	1	501078	26TU16
			1.6240	1-1/2	501079	26TU24
1-3/4	1.7487 1.7471	1.9381 1.9371	1.7535	1	501080	28TU16
			1.7489	1-1/2	501081	28TU24
				1-3/4	501082	28TU28
				2	501083	28TU32
1-7/8	1.8737 1.8721	2.0633 2.0621	1.8787	3/4	501084	30TU12
			1.8739	1	501085	30TU16
				1-7/8	501086	30TU30
				2-1/4	501087	30TU36
2	1.9987 1.9969	2.1883 2.1871	2.0037	1/2	501088	32TU08
			1.9989	1	501089	32TU16
				1-1/2	501090	32TU24
				1-3/4	501091	32TU28
				2	501092	32TU32
			2-1/2	501093	32TU40	
2 1/8	2.1257 2.1239	2.3130 2.3118	2.1326	3	501094	34TU48
			2.1262			
2 1/4	2.2507 2.2489	2.4377 2.4365	2.2573	1 3/4	501095	36TU28
			2.2509	2	501096	36TU32
				2 1/4	501097	36TU36
				2 1/2	501098	36TU40
			3	501099	36TU48	
2 1/2	2.5011 2.4993	2.6881 2.6869	2.5077	1	501104	40TU16
			2.5013	1 5/8	501105	40TU26
				2	501106	40TU32
				2 1/2	501107	40TU40
				3	501108	40TU48
				3 1/2	501109	40TU56
			4 3/4	501113	40TU76	
2 3/4	2.7500 2.7482	2.9370 2.9358	2.7566	2	501114	44TU32
			2.7502	2 1/2	501116	44TU40
				3	501117	44TU48
				3 1/2	501118	44TU56
				5	501123	44TU80
2 7/8	2.8752 2.8734	3.0623 3.0610	2.8819	2	501124	46TU32
			2.8754	2 1/2	501126	46TU40
				3	501127	46TU48
3	3.0000 2.9982	3.1872 3.1858	3.0068	2	501134	48TU32
			3.0002	2 1/4	501135	48TU36
				2 1/2	501136	48TU40
				3	501137	48TU48
				3 3/4	501139	48TU60
				4 1/2	501141	48TU72
			5	501143	48TU80	
3 1/4	3.2500 3.2480	3.4372 3.4358	3.2568	2	501144	52TU32
			3.2502	2 3/8	501145	52TU38
				2 1/2	501146	52TU40
				3	501147	52TU48
				3 1/2	501148	52TU56
			4	501150	52TU64	
			5	501153	52TU80	
3 1/2	3.5000 3.4978	3.6872 3.6858	3.5068	2	501154	56TU32
			3.5002	2 3/8	501155	56TU38
				2 1/2	501156	56TU40
				3	501157	56TU48
				3 1/2	501158	56TU56
			3 3/4	501159	56TU60	

*Other sizes are available on special orders



TU™ SLEEVE BEARINGS (Inch Sizes)

Nominal Bearing Bore	Recommended		Installed Bearing I.D.	Length ± .010"	Item Number	Part Number
	Shaft Dia.	Housing Bore				
3 5/8	3.6250	3.8122	3.6318	2	501164	58TU32
	3.6228	3.8108	3.6252	2 1/2	501166	58TU40
				3	501167	58TU48
				3 3/4	501169	58TU60
3 3/4	3.7500	3.9372	3.7568	2	501174	60TU32
	3.7478	3.9358	3.7502	2 1/2	501176	60TU40
				3	501177	60TU48
				3 1/2	501178	60TU56
				3 3/4	501179	60TU60
			5	501180	60TU80	
4	4.0000	4.1872	4.0068	2	501184	64TU32
	3.9978	4.1858	4.0002	2 1/4	501185	64TU36
				2 1/2	501186	64TU40
				3	501187	64TU48
				3 1/2	501188	64TU56
				3 3/4	501189	64TU60
			4	501190	64TU64	
			4 3/4	501192	64TU76	
4 1/4	4.2500	4.4373	4.2568	2	501194	68TU32
	4.2478	4.4358	4.2502	3	501197	68TU48
				3 1/2	501198	68TU56
				4	501200	68TU64
4 3/8	4.3750	4.5622	4.3818	2	501204	70TU32
	4.3728	4.5608	4.3752	2 1/4	501205	70TU36
				3	501207	70TU48
				4	501210	70TU64
4 1/2	4.5000	4.6872	4.5068	2	501214	72TU32
	4.4978	4.6858	4.5002	3	501217	72TU48
				3 1/2	501218	72TU56
				4	501220	72TU64
				4 1/2	501221	72TU72
				4 3/4	501222	72TU76
4 3/4	4.7500	4.9374	4.7572	2	501224	76TU32
	4.7475	4.9358	4.7502	3 1/2	501228	76TU56
				4	501230	76TU64
				4 3/4	501232	76TU76
5	4.9986	5.1860	5.0056	2	501234	80TU32
	4.9961	5.1844	4.9988	2 1/2	501236	80TU40
				3	501237	80TU48
				3 1/2	501238	80TU56
				3 3/4	501239	80TU60
			5	501243	80TU80	
5 1/4	5.2500	5.4374	5.2570	2	501244	84TU32
	5.2475	5.4358	5.2502	3	501247	84TU48
				3 3/4	501249	84TU60
				4 1/2	501251	84TU72
5 1/2	5.5000	5.6874	5.5070	2	501254	88TU32
	4.4975	5.6858	5.5002	3	501257	88TU48
				3 3/4	501259	88TU60
				4	501260	88TU64
				4 1/2	501261	88TU72
5 3/4	5.7500	5.9374	5.7570	2	501264	92TU32
	5.7475	5.9358	5.7502	3	501267	92TU48
				4	501270	92TU64
				5	501273	92TU80
6	6.0000	6.1874	6.0070	2	501274	96TU32
	5.9975	6.1858	6.0002	3	501277	96TU48
				3 1/2	501278	96TU56
				3 3/4	501279	96TU60
				4	501280	96TU64
6 1/4	6.2500	6.4374	6.2570	2	501284	100TU32
	6.2475	6.4358	6.2502	3	501287	100TU48
				4	501290	100TU64
				4 1/2	501291	100TU72
				5	501293	100TU80
6 1/2	6.5000	6.6874	6.5070	3	501297	104TU48
	6.4975	6.6858	6.5002	3 1/2	501298	104TU56
				4	501300	104TU64
				5	501303	104TU80

Nominal Bearing Bore	Recommended		Installed Bearing I.D.	Length ± .010"	Item Number	Part Number
	Shaft Dia.	Housing Bore				
6 3/4	6.7500	6.9374	6.7570	3	501307	108TU48
	6.7475	6.9358	6.7502	3 1/2	501308	108TU56
				4	501310	108TU64
				5	501313	108TU80
7	6.9954	7.1830	7.0026	3	501317	112TU48
	6.9929	7.1812	6.9956	3 3/4	501319	112TU60
				4	501320	112TU64
				5	501323	112TU80

TU™ FLANGE BEARINGS (Inch Sizes)

Nominal Bearing Bore I.D.	Recommended		Installed Bearing I.D.	Nominal Flange O.D. ± .020"	Flange Thick.	Length ± .010"	Item Number	Part Number
	Shaft Dia.	Housing Bore						
3/8	0.3740	0.4691	0.3769	11/16	.052	1/4	502001	06FTU04
	0.3731	0.4684	0.3742		.044	3/8	502002	06FTU06
						1/2	502003	06FTU08
						3/4	502004	06FTU12
1/2	0.4990	0.5941	0.5019	13/16	.052	1/4	502005	08FTU04
	0.4980	0.5934	0.4992		.044	3/8	502006	08FTU06
						1/2	502007	08FTU08
						3/4	502008	08FTU12
5/8	0.6240	0.7192	0.6270	15/16	.052	3/8	502009	10FTU06
	0.6230	0.7184	0.6242		.044	1/2	502010	10FTU08
						5/8	502011	10FTU10
						3/4	502012	10FTU12
3/4	0.7491	0.8755	0.7525	1 1/8	.068	3/8	502013	12FTU06
	0.7479	0.8747	0.7493		.060	1/2	502014	12FTU08
						3/4	502015	12FTU12
						1	502016	12FTU16
7/8	0.8741	1.0005	0.8775	1 1/4	.068	1/2	502017	14FTU08
	0.8729	0.9997	0.8743		.060	3/4	502018	14FTU12
						1	502019	14FTU16
						1 1/4	502020	14FTU20
1	0.9991	1.1256	1.0026	1 3/8	.068	1/2	502021	16FTU08
	0.9979	1.1246	0.9992		.060	3/4	502022	16FTU12
						1	502023	16FTU16
						1 1/4	502024	16FTU20
1 1/4	1.2488	1.4068	1.2528	1 3/4	.083	1	502025	20FTU16
	1.2472	1.4058	1.2490		.075	1 1/4	502026	20FTU20
						1 1/2	502027	20FTU24
1 1/2	1.4988	1.6568	1.5028	2	.083	1	502028	24FTU16
	1.4972	1.6558	1.4990		.075	1 1/2	502029	24FTU24
						2	502030	24FTU32
1 3/4	1.7487	1.9381	1.7535	2 3/8	.098	1	502031	28FTU16
	1.7471	1.9371	1.7489		.090	1 1/2	502032	28FTU24
						2	502033	28FTU32

Chamfers: Standard flanged TU Bearings are supplied with 15°/20° chamfers
*Other sizes are available on special orders

For TU™ Washers in Inch Sizes refer to page 58





TU™ SLEEVE BEARINGS (Metric Sizes)

Nominal Bearing Bore	Recommended		Installed Bearing I.D.	Length ± .25mm	Item Number	Part Number
	Shaft Dia.	Housing Bore				
2	2.000	3.508	2.048	3	701001	M0203TU
	1.994	3.500	2.000	5	701002	M0205TU
3	3.000	4.508	3.048	3	701003	M0303TU
	2.994	4.500	3.000	4	701004	M0304TU
				5	701005	M0305TU
				6	701006	M0306TU
4	4.000	5.508	4.048	3	701007	M0403TU
	3.992	5.500	4.000	4	701008	M0404TU
				6	701009	M0406TU
				10	701010	M0410TU
5	4.990	7.015	5.055	5	701011	M0505TU
	4.978	7.000	4.990	8	701012	M0508TU
				10	701013	M0510TU
6	5.990	8.015	6.055	6	701015	M0606TU
	5.978	8.000	5.990	8	701016	M0608TU
				10	701017	M0610TU
7	6.987	9.015	7.055	10	701018	M0710TU
	6.972	9.000	6.990			
8	7.987	10.015	8.055	8	701020	M0808TU
	7.972	10.000	7.990	10	701021	M0810TU
				12	701022	M0812TU
10	9.987	12.018	10.058	8	701023	M1008TU
	9.972	12.000	9.990	10	701024	M1010TU
				12	701025	M1012TU
				15	701026	M1015TU
				20	701027	M1020TU
12	11.984	14.018	12.058	8	701028	M1208TU
	11.966	14.000	11.990	10	701029	M1210TU
				12	701030	M1212TU
				15	701031	M1215TU
				20	701032	M1220TU
25	701033	M1225TU				
13	12.984	15.018	13.058	10	701034	M1310TU
	12.966	15.000	12.990	20	701035	M1320TU
14	13.984	16.018	14.058	10	701037	M1410TU
	13.966	16.000	13.990	12	701038	M1412TU
				15	701039	M1415TU
				20	701040	M1420TU
				25	701041	M1425TU
15	14.984	17.018	15.058	10	701042	M1510TU
	14.966	17.000	14.990	12	701043	M1512TU
				15	701044	M1515TU
				20	701045	M1520TU
				25	701046	M1525TU
16	15.984	18.018	16.058	10	701047	M1610TU
	15.966	18.000	15.990	12	701048	M1612TU
				15	701049	M1615TU
				20	701050	M1620TU
25	701051	M1625TU				
17	16.984	19.021	17.061	15	701052	M1715TU
	16.966	19.000	16.990	20	701053	M1720TU
18	17.984	20.021	18.061	15	701055	M1815TU
	17.966	20.000	17.990	20	701056	M1820TU
				25	701057	M1825TU
20	19.980	23.021	20.062	10	701061	M2010TU
	19.959	23.000	19.990	15	701062	M2015TU
				20	701063	M2020TU
				25	701064	M2025TU
				30	701065	M2030TU
22	21.980	25.021	22.071	15	701066	M2215TU
	21.959	25.000	21.990	20	701067	M2220TU
				25	701068	M2225TU
				30	701069	M2230TU
24	23.980	27.021	24.071	15	701070	M2415TU
	23.959	27.000	23.990	20	701071	M2420TU
				25	701072	M2425TU
				30	701073	M2430TU

Nominal Bearing Bore	Recommended		Installed Bearing I.D.	Length ± .25mm	Item Number	Part Number
	Shaft Dia.	Housing Bore				
25	24.980	28.021	25.071	12	701078	M2512TU
	24.959	28.000	24.990	15	701079	M2515TU
				20	701080	M2520TU
				25	701081	M2525TU
				30	701082	M2530TU
50	701083	M2550TU				
28	27.980	32.025	28.085	15	701084	M2815TU
	27.959	32.000	27.990	20	701085	M2820TU
				25	701086	M2825TU
				30	701087	M2830TU
30	29.980	34.025	30.085	15	701089	M3015TU
	29.959	34.000	29.990	20	701090	M3020TU
				25	701091	M3025TU
				30	701092	M3030TU
				40	701093	M3040TU
32	31.975	36.025	32.085	20	701094	M3220TU
	31.950	36.000	31.990	30	701095	M3230TU
				40	701096	M3240TU
35	34.975	39.025	35.085	20	701097	M3520TU
	34.950	39.000	34.990	30	701098	M3530TU
				35	701099	M3535TU
				40	701100	M3540TU
				50	701101	M3550TU
40	39.975	44.025	40.085	20	701103	M4020TU
	39.950	44.000	39.990	30	701104	M4030TU
				40	701105	M4040TU
				50	701107	M4050TU
45	44.975	50.025	45.105	20	701108	M4520TU
	44.950	50.000	44.990	30	701109	M4530TU
				40	701110	M4540TU
				45	701111	M4545TU
				50	701112	M4550TU
50	49.975	55.530	50.110	20	701113	M5020TU
	49.950	55.000	49.990	30	701115	M5030TU
				40	701116	M5040TU
				50	701117	M5050TU
				60	701118	M5060TU
55	54.970	60.030	55.110	20	701119	M5520TU
	54.940	60.000	54.990	25	701120	M5525TU
				30	701121	M5530TU
				40	701122	M5540TU
				50	701123	M5550TU
55	701124	M5555TU				
60	701125	M5560TU				
60	59.970	65.030	60.110	30	701127	M6030TU
	59.940	65.000	59.990	40	701128	M6040TU
				60	701130	M6060TU
				70	701131	M6070TU
65	64.970	70.030	65.110	30	701132	M6530TU
	64.940	70.000	64.990	50	701134	M6550TU
				70	701135	M6570TU
70	69.970	75.030	70.110	40	701136	M7040TU
	69.940	75.000	69.990	50	701137	M7050TU
				60	701138	M7060TU
				70	701139	M7070TU
75	74.970	80.030	75.110	40	701140	M7540TU
	74.940	80.000	74.990	50	701141	M7550TU
				60	701142	M7560TU
80	701144	M7580TU				
80	80.000	85.035	80.145	60	701145	M8060TU
	79.954	85.000	80.010	100	701147	M80100TU
85	85.000	90.035	85.145	30	701148	M8530TU
	84.946	90.000	85.010	60	701149	M8560TU
				100	701150	M85100TU
90	90.000	95.035	90.145	60	701151	M9060TU
	89.946	95.000	90.010	100	701152	M90100TU
95	95.000	100.035	95.145	60	701153	M9560TU
	94.946	100.000	95.010	100	701154	M95100TU

*Other sizes are available on special orders



TU™ SLEEVE BEARINGS (Metric Sizes)

Nominal Bearing Bore	Recommended		Installed Bearing I.D.	Length ± .25mm	Item Number	Part Number
	Shaft Dia.	Housing Bore				
100	100.000	105.035	100.145	60	701156	M10060TU
	99.946	105.000	100.010	70	701157	M10070TU
				80	701158	M10080TU
				115	701160	M100115TU
105	105.000	110.035	105.145	60	701161	M10560TU
	104.946	110.000	105.010	115	701163	M105115TU
110	110.000	115.035	110.145	60	701164	M11060TU
	109.946	115.000	110.010	115	701166	M110115TU
115	115.000	120.035	115.145	50	701167	M11550TU
	114.946	120.000	115.010	60	701168	M11560TU
				70	701169	M11570TU
120	120.000	125.040	120.220	50	701171	M12050TU
	119.946	125.000	120.048	60	701172	M12060TU
				100	701173	M120100TU
125	125.000	130.040	125.220	60	701174	M12560TU
	124.937	130.000	125.048	100	701175	M125100TU
130	130.000	135.040	130.220	60	701176	M13060TU
	129.937	135.000	130.048	100	701177	M130100TU
135	135.000	140.040	135.220	60	701178	M13560TU
	134.937	140.000	135.048	80	701179	M13580TU
				100	701180	M135100TU
140	140.000	145.040	140.220	60	701181	M14060TU
	139.937	145.000	140.048	100	701182	M140100TU
150	150.000	155.040	150.220	60	701185	M15060TU
	149.937	155.000	150.048	80	701186	M15080TU
				100	701187	M150100TU
160	160.000	165.040	160.220	60	701190	M16060TU
	159.937	165.000	160.048	80	701191	M16080TU
				100	701192	M160100TU
180	180.000	185.046	180.220	60	701199	M18060TU
	179.937	185.000	180.048	100	701201	M180100TU
200	200.000	205.046	200.220	60	701204	M20060TU
	199.928	205.000	200.048	100	701205	M200100TU
220	220.000	225.046	220.220	60	701212	M22060TU
	219.928	225.000	220.048	100	701213	M220100TU
250	250.000	255.052	250.220	60	701218	M25060TU
	249.928	255.000	250.048	100	701219	M250100TU
300	300.000	305.052	300.220	60	701222	M30060TU
	299.919	305.000	300.048	100	701223	M300100TU

TU™ FLANGED BEARINGS (Metric Sizes)

Nominal Bearing Bore I.D.	Recommended		Installed Bearing I.D.	Nominal Flange O.D. ±.05mm	Flange Thick. ±.25mm	Length ±.25mm	Item Number	Part Number
	Shaft Dia.	Housing Bore						
6	5.990	8.015	6.055	12	1.00	4	702001	FM0604TU
	5.978	8.000	5.990		.80	7	702002	FM0607TU
						8	702003	FM0608TU
8	7.987	10.015	8.055	15	1.00	5.5	702004	FM0805.5TU
	7.972	10.000	7.990		.80	7.5	702005	FM0807.5TU
						9.5	702006	FM0809.5TU
10	9.987	12.018	10.058	18	1.00	7	702007	FM1007TU
	9.972	12.000	9.990		.80	9	702008	FM1009TU
						12	702009	FM1012TU
						17	702010	FM1017TU
12	11.984	14.018	12.058	20	1.00	7	702011	FM1207TU
	11.966	14.000	11.990		.80	9	702012	FM1209TU
						12	702013	FM1212TU
						17	702014	FM1217TU
14	13.984	16.018	14.058	22	1.00	12	702015	FM1412TU
	13.966	16.000	13.990		.80	17	702016	FM1417TU
15	14.984	17.018	15.058	23	1.00	9	702017	FM1509TU
	14.966	17.000	14.990		.80	12	702018	FM1512TU
						17	702019	FM1517TU
16	15.984	18.018	16.058	24	1.00	12	702020	FM1612TU
	15.966	18.000	15.990		.80	17	702021	FM1617TU
18	17.984	20.021	18.061	26	1.00	12	702022	FM1812TU
	17.966	20.000	17.990		.80	17	702023	FM1817TU
						22	702024	FM1822TU
20	19.980	23.021	20.062	30	1.50	11.5	702025	FM2011.5TU
	19.959	23.000	19.990		1.30	16.5	702026	FM2016.5TU
						21.5	702027	FM2021.5TU
25	24.980	28.021	25.071	35	1.50	11.5	702028	FM2511.5TU
	24.959	28.000	24.990		1.30	16.5	702029	FM2516.5TU
						21.5	702030	FM2521.5TU
30	29.980	34.025	30.085	42	2.00	16	702031	FM3016TU
	29.959	34.000	29.990		1.80	26	702032	FM3026TU
35	34.975	39.025	35.085	47	2.00	16	702033	FM3516TU
	34.950	39.000	34.990		1.80	26	702034	FM3526TU
40	39.975	44.025	40.085	52	2.00	16	702035	FM4016TU
	39.950	44.000	39.990		1.80	26	702036	FM4026TU

Chamfers: Standard flanged TU Bearings are supplied with 15°/20° chamfers
*Other sizes are available on special orders

For TU™ Washers in Metric Sizes refer to page 58



TU™ Washers (Inch Sizes)

Inside Diameter +.010	Outside Diameter -.010	Thickness +.0020	Dowel Hole		Housing Recess Depth +.010	Item Number	Part Number
			Diameter +.010	P.C. Diameter -.010			
.500	.875	.061	.067	.692	.040	502401	W06TU
.562	1.000	.061	.067	.786	.040	502402	W07TU
.625	1.125	.061	.099	.880	.040	502403	W08TU
.687	1.187	.061	.099	.942	.040	502404	W09TU
.750	1.250	.061	.099	1.005	.040	502405	W10TU
.812	1.375	.061	.099	1.099	.040	502406	W11TU
.875	1.500	.061	.130	1.192	.040	503407	W12TU
.937	1.625	.061	.130	1.286	.040	502408	W13TU
1.000	1.750	.061	.130	1.380	.040	502409	W14TU
1.125	2.000	.061	.161	1.567	.040	502410	W16TU
1.250	2.125	.061	.161	1.692	.040	502411	W18TU
1.375	2.250	.061	.161	1.817	.040	502412	W20TU
1.500	2.500	.061	.192	2.005	.040	502413	W22TU
1.625	2.625	.061	.192	2.130	.040	502414	W24TU
1.750	2.750	.061	.192	2.255	.040	502415	W26TU
2.000	3.000	.091	.192	2.505	.070	502416	W28TU
2.125	3.125	.091	.192	2.630	.070	502417	W30TU
2.250	3.250	.091	.192	2.755	.070	502418	W32TU

Chamfers: Standard flanged TU Bearings are supplied with 15°/20° chamfers

*Other sizes are available on special orders

TU™ Washers (Metric Sizes)

Inside Diameter +.25mm	Outside Diameter -.25mm	Thickness +.05mm	Dowel Hole		Housing Recess Depth +.25mm	Item Number	Part Number
			Diameter +.25mm	P.C. Diameter -.24mm			
10.00	20.00	1.45	—	—	.95	702401	WM08TU
12.00	24.00	1.45	1.620	18.12	.95	702402	WM10TU
14.00	26.00	1.45	2.120	20.12	.95	702403	WM12TU
16.00	30.00	1.45	2.120	22.12	.95	702404	WM14TU
18.00	32.00	1.45	2.120	25.12	.95	702405	WM16TU
20.00	36.00	1.45	3.120	28.12	.95	702406	WM18TU
22.00	38.00	1.45	3.120	30.12	.95	702407	WM20TU
24.00	42.00	1.45	3.120	33.12	.95	702408	WM22TU
26.00	44.00	1.45	3.120	35.12	.95	702409	WM24TU
28.00	48.00	1.45	4.120	38.12	.95	702410	WM25TU
32.00	54.00	1.45	4.120	43.12	.95	702411	WM30TU
38.00	62.00	1.45	4.120	50.12	.95	702412	WM35TU
42.00	66.00	1.45	4.120	54.12	.95	702413	WM40TU
48.00	74.00	1.95	4.120	61.12	1.45	702414	WM45TU
52.00	78.00	1.95	4.120	65.12	1.45	703415	WM50TU
62.00	90.00	1.95	4.120	76.12	1.45	702416	WM60TU

For TU™ Sleeve & Flange Bearings in Inch Sizes refer to pages 54 & 55



For TU™ Sleeve & Flange Bearings in Metric Sizes refer to pages 56 & 57





TP™ LEAD-FREE STEEL-BACKED PTFE LINED BEARINGS

TP™ SLEEVE BEARINGS (Inch Sizes)

Nominal Bearing Bore I.D.	Recommended		Installed Bearing I.D.	Length ± .010"	Item Number	Part Number
	Shaft Dia.	Housing Bore				
1/4	.2490 .2481	.3128 .3122	.2518 .2492	3/8	505009	04TP06
5/16	.3115 .3106	.3753 .3747	.3143 .3117	1/2	505011	05TP08
3/8	.3740 .3731	.4691 .4684	.3769 .3742	3/4	505017	06TP12
1/2	.4990 .4980	.5941 .5934	.5019 .4992	1/2 3/4	505022 505024	08TP08 08TP12
9/16	.5615 .5605	.6566 .6559	.5644 .5617	3/4	505029	09TP12
5/8	.6240 .6230	.7192 .7184	.6270 .6242	1/2 3/4	505031 505033	10TP08 10TP12
3/4	.7491 .7479	.8755 .8747	.7525 .7493	1/2 3/4 1	505039 505041 505042	12TP08 12TP12 12TP16
7/8	.8741 .8729	1.0005 .9997	.8775 .8743	1	505049	14TP16
1	.9991 .9979	1.1255 1.1247	1.0025 .9993	1/2 3/4 1 1 1/4 1 1/2	505052 505053 505054 505055 505056	12TP08 12TP12 16TP16 16TP20 16TP24
1 1/4	1.2488 1.2472	1.4068 1.4058	1.2528 1.2490	3/4 1	505062 505064	20TP12 20TP16
1 1/2	1.4988 1.4972	1.6568 1.6558	1.5028 1.4990	1 1 1/2	505073 505076	24TU16 24TU24
1 3/4	1.7487 1.7471	1.9381 1.9371	1.7535 1.7489	2	505083	28TP32
2	1.9987 1.9969	2.1883 2.1871	2.0037 1.9989	1 1/2 2	505090 505092	32TP24 32TP32

TP™ FLANGE BEARINGS (Inch Sizes)

Nominal Bearing Bore I.D.	Recommended		Installed Bearing I.D.	Nominal Flange O.D. ±.020"	Flange Thick. ±.010"	Length ±.010"	Item Number	Part Number
	Shaft Diameter	Housing Bore						
3/8	.3740 .3731	.4691 .4684	.3764 .3742	11/16	.052 .044	3/8 1/2	506002 506003	06FTP06 06FTP08
1/2	.4990 .4980	.5941 .5934	.5019 .4992	13/16	.052 .044	3/4	506008	08FTP12
5/8	.6240 .6230	.7192 .7184	.6270 .6242	15/16	.052 .044	1/2	506010	10FTP08
3/4	.7491 .7479	.8755 .8747	.7525 .7493	1 1/8	.068 .060	1	506016	12FTP16
1 1/4	1.2488 1.2472	1.4068 1.4058	1.2528 1.2490	1 3/4	.083 .075	1	506025	20FTP16

TP™ WASHERS (Inch Sizes)

Inside Diameter +.010"	Outside Diameter -.010"	Dowel Hole		P.C. Diameter -.010"	Housing Recess Depth ±.010"	Item Number	Part Number
		Thickness +.002	Diameter +.010"				
9/16	1	.061	.067	.786	.040	506402	W07TP
1 1/2	2 1/2	.061	.192	2.005	.040	506413	W22TP

TP™ SLEEVE BEARINGS (Metric Sizes)

Nominal Bearing Bore I.D.	Recommended		Installed Bearing I.D.	Length ±.25mm	Item Number	Part Number
	Shaft Dia.	Housing Bore				
4	4.000 3.992	5.508 5.500	4.048 4.000	6	705009	M0406TP
6	5.990 5.978	8.015 8.000	6.055 5.990	10	705017	M0610TP
8	7.987 7.972	10.015 10.000	8.055 7.990	10	705021	M0810TP
10	9.987 9.972	12.018 12.000	10.058 9.990	12	705025	M1012TP
12	11.984 11.966	14.018 14.000	12.058 11.990	15	705031	M1215TP
14	13.984 13.966	16.018 16.000	14.058 13.990	12	705038	M1412TP
15	14.984 14.966	17.018 17.000	15.058 14.990	12	705043	M1512TP
16	15.984 15.966	18.018 18.000	16.058 15.990	25	705051	M1625TP
20	19.980 19.959	23.021 23.000	20.062 19.990	20	705062	M2820TP
25	24.980 24.959	28.021 28.000	25.071 24.990	15	705079	M2515TP
30	29.980 29.959	34.025 34.000	30.085 29.990	40	705093	M3040TP
50	49.975 49.950	55.530 55.000	50.110 49.990	50	705117	M5050TP

TP™ FLANGE BEARINGS (Metric Sizes)

Nominal Bearing Bore I.D.	Recommended		Installed Bearing I.D.	Nominal Flange O.D. ±.05mm	Flange Thick. ±.25mm	Length ±.25mm	Item Number	Part Number
	Shaft Diameter	Housing Bore						
6	5.990 5.978	8.015 8.000	6.055 5.990	12	1.00 .80	8	706003	FM0608TP
8	7.987 7.972	10.015 10.000	8.055 7.990	15	1.00 .80	9.5	706006	FM0809.5TP
12	11.984 11.966	14.018 14.000	12.058 11.990	20	1.00 .80	12	706013	FM1212TP
15	14.924 14.966	17.018 17.000	15.058 14.990	23	1.00 .80	12	706018	FM1512TP
16	15.984 15.966	18.018 18.000	16.058 15.990	24	1.00 .80	12	706020	FM1612TP

TP™ WASHERS (Metric Sizes)

Inside Diameter +.25mm	Outside Diameter -.25mm	Dowel Hole		P.C. Diameter +.24mm	Housing Recess Depth ±.25mm	Item Number	Part Number
		Thickness +.05mm	Diameter +.25mm				
10	20	1.45	N/A	N/A	N/A	706401	WM8TP
28	48	1.45	4.120	38	1.0	706410	WM25TP
52	78	1.95	4.120	65	1.5	706415	WM50TP

Chamfers: Standard flanged TP Bearings are supplied with 15°/20° chamfers.
*Other sizes available on special orders.

Note: The items on this page represent a portion of the TP™ products available at the time of printing. Visit our website (www.Isostatic.com) for a complete list of TP™ products or phone **Customer Service** at **800 621-5500** with any questions.